

All Products Guide

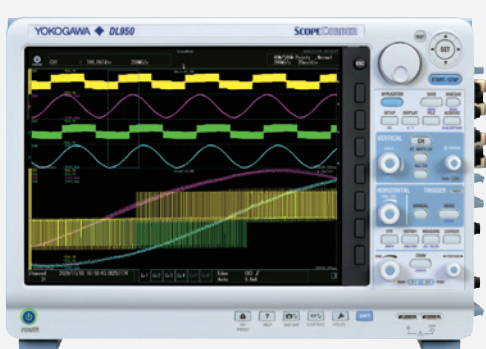

Main Products Line Up

Oscilloscopes



DLM5000HD/DLM5000 Series DLM3000 Series
High Definition Oscilloscope, Mixed Signal Oscilloscope

DL950 DL350
ScopeCorder

SL1000
High-Speed Data Acquisition Unit

Digital Power Analyzers



WT5000 WT1800E
Precision Power Analyzer

PX8000
Precision Power Scope

WT500
Power Analyzer

WT310E/WT330E Series
Digital Power Meters

Integrated Software Platform



IS8000 Series
Integrated Software Platform

Generators, Sources, Manometers etc.



GS200 GS610 GS820
DC Voltage/Current Source,
Multi Channel Source Measure Unit, Source Measure Unit

LS3300
AC Power Calibrator

2553A 2560A
Precision DC Calibrator



2558A
AC Voltage Current Standard







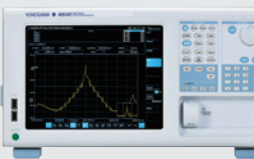

DM7560
Digital Multimeter

FG400 Series
Arbitrary/Function Generator

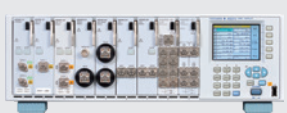
MC100
Pneumatic Pressure Standard

MT300
Digital Multimeter

Optical Measuring Instruments

 <p>AQ6380</p>	 <p>AQ6370 Series</p>	 <p>AQ6150 Series</p>	 <p>AQ2200 Series</p>		
Optical Spectrum Analyzer		Optical Wavelength Meter	Multi Application Test System		
 <p>AQ7280 Series</p>	 <p>AQ1210 Series</p>	 <p>AQ1000</p>	 <p>AQ1100 Series</p>	 <p>AQ1300 Series</p>	 <p>AQ2170 AQ2180 AQ4280</p>
Optical Time Domain Reflectometer			Optical Loss Test Set	Ethernet Multi Field Tester	Optical Power Meter Optical Light Source

Portable and Handheld Instruments

 <p>CA700</p>	 <p>PM100</p>	 <p>CA500 Series</p>	 <p>CA71</p>	 <p>CA450</p>	 <p>CA310</p>	 <p>CA320</p>	 <p>CA330</p>	 <p>TY700 Series</p>	 <p>TY500 Series</p>
Calibrator								Digital Multimeter	
 <p>CL150/155</p>	 <p>CL220</p>	 <p>300 Series</p>	 <p>CL420</p>	 <p>MY600</p>	 <p>EY200</p>	 <p>TX1001</p>	 <p>TX1002</p>	 <p>TX1003</p>	
Clamp-on Tester				Digital Insulation Tester	Digital Earth Tester	Digital Thermometer			
 <p>CW500</p>	 <p>279301/279303</p>	 <p>278610/278620</p>	 <p>2792A Series</p>						
Power Quality Analyzer	Decade Resistance Box		Standard Resistor						

Oscilloscopes

ScopeCorder and High-Speed Data Acquisition Unit	
Selection Guide	6
ScopeCorder	
DL950	8
DL350	10
High-Speed Data Acquisition Unit	
SL1000	12
SL1000 Acquisition Software.....	13
Accessories for above products	14
Module and accessory combinations.....	15
High Definition and Mixed Signal Oscilloscopes	
Selection Guide	18
High Definition Oscilloscope	
DLM5000HD Series.....	20
Mixed Signal Oscilloscope	
DLM5000 Series.....	20
DLM3000 Series.....	24
Accessories for Oscilloscopes	26
Application Software	27

Digital Power Analyzers

Power Analyzers and Power Meters	
Selection Guide	28
Power Analyzer	
WT500	29
Precision Power Analyzer	
WT5000	30
WT1800E	34
Digital Power Meters	
WT300E Series.....	36
Precision Power Scope	
PX8000	38
AC/DC Current Sensor	
CT60/CT200/CT1000/CT1000A/CT1200D/CT2000A	40
Current Probe	
751552.....	40
Current Sensor Unit	
751522/751524	40
Accessory and Software	
761941 WTViewerE Application Software.....	41
Power Consumption Measurement Software (Free Software).....	41
761922 Harmonic/Flicker Measurement Software.....	42
Accessories List	43

Integrated Software Platform

Integrated Software Platform	
IS8000 Series	44

Generators, Sources, Manometers etc.

DC Voltage/Current Source	
GS200.....	46
Multi Channel Source Measure Unit	
GS820.....	47
Source Measure Unit	
GS610.....	48
GS Series Accessory Software	
Curve Tracer Software 765670	49
AC Power Calibrator	
LS3300	50
Precision DC Calibrator	
2560A	51
Power Meter Calibration Software (Free Software)	52
Precision DC Calibrator	
2553A	53
AC Voltage Current Standard	
2558A	54
Digital Multimeter	
DM7560	55
Arbitrary/Function Generator	
FG400 Series	56
Pneumatic Pressure Standard	
MC100	57
Digital Manometer	
MT300.....	58

Optical Measuring Instruments

Optical Spectrum Analyzer	
Selection Guide	60
AQ6380.....	64
AQ6370E	66
AQ6373E	68
AQ6374E	69
AQ6375E	70
AQ6376E	72
AQ6377.....	73
AQ6360.....	74
Optical Wavelength Meter	
AQ6150 Series	76

Multi Application Test System

AQ2200 Series 78

Optical Time Domain Reflectometer

Selection Guide 80

AQ7280 Series 82

AQ1210 Series 84

AQ1000..... 86

Optical Power Meter / Optical Light Source

AQ2170/AQ2180/AQ4280..... 87

Optical Loss Test Set

AQ1100 Series 88

Ethernet Multi Field Tester

AQ1300 Series 89

Portable and Handheld Instruments

Process Calibrator

Selection Guide 90

Pressure Calibrator

CA700..... 92

External Pressure Sensor

PM100 94

Multi Function Calibrator

CA500/CA550..... 96

CA71/CA51..... 98

Process Multi Meter

CA450..... 99

Volt mA Calibrator

CA310..... 100

TC Calibrator

CA320..... 100

RTD Calibrator

CA330..... 101

Clamp-on Tester

Selection Guide 104

Clamp-on Tester

CL120/CL150/CL155/CL220/CL250/CL255..... 105

Leakage Clamp-on Tester

CL320/CL340/CL345/30031A/30032A/CL360 107

Clamp-on Process Meter

CL420 109

Digital Multimeter

Selection Guide 110

TY700 Series..... 111

TY500 Series..... 112

Communication Package 92015..... 113

Accessories..... 113

Digital Insulation Tester

MY600 114

Digital Earth Tester

EY200 115

Digital Thermometer

TX10 Series..... 116

Power Quality Analyzer

CW500..... 117

Decade Resistance Box

279301/279303 119

278610/278620 119

Standard Resistor

2792A Series..... 119

Recorders, Data loggers

SMARTDAC+ Paperless Recorder

GP Series 120

Data Acquisition System

GM..... 120

SMARTDAC+ Data Logging Software

GA10..... 121

Worldwide Business Operations 122

<https://tmi.yokogawa.com/> 123

ScopeCorder and High-Speed Data Acquisition Unit Selection Guide*1

They can be used to capture single-shot or infrequently recurring signals.
They can also execute computations on repetitive waveforms, and automatically extract waveform parameters.



...P.8

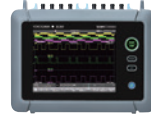

...P.10



...P.12

Item	Product Type/ Model	ScopeCorder DL950	ScopeCorder DL350	High-Speed Data Acquisition Unit SL1000
Features		<ul style="list-style-type: none"> Powerful mobile data acquisition recorders Measure & analyze dynamic behavior of electromechanical systems Flexible modular inputs for voltage, current, sensors, CAN/CAN FD/LIN bus and SENT. Long recording to internal flash memory at 20 MS/s (optional) Trend & Trigger on electrical power calculations (optional) GPS/IRIG capability (optional) 	<ul style="list-style-type: none"> A4-sized compact chassis AC/DC/Battery operated Up to 50 days continuous recording onto SD card Vibration-resistant design Intuitive operation using 8.4-inch touch screen Flexible modular inputs for voltage, current, sensors, CAN/CAN FD/LIN bus and SENT. GPS capability⁵ 	<ul style="list-style-type: none"> Fast Acquisition, Transfer, and Storage High-Performance Data Acquisition Unit Easy to use Easy to use Standard Acquisition Software Max. 128 ch Synchronized (16 ch × 8 units) Data files recorded by multiple units, in synchronized mode, are all linked together by a common LINK file, thereby facilitating batch processing.
Max. sampling rate		200 MS/s ²	100 MS/s ²	100 MS/s ²
Bandwidth		40 MHz ²	20 MHz ²	20 MHz ²
Number of analog input channels		32 ch max. (when using eight 720256 modules)	32 ch max. (when using two 720220 modules)	16 ch max. (when using any 2 ch input module.) 128 ch max. synchronized (16 ch × 8 units)
Logic input		128 bits max. (when using eight 720230 modules)	48 bits max. (when using two 720230 modules and logic input terminals)	—
Max. vertical sensitivity (1:1)		100 μV/div ²	100 μV/div ²	100 μV/div ²
Vertical axis resolution		16 bit ²	16 bit ²	16 bit ²
Max. sweep sensitivity		100 ns/div ²	1 μs/div ²	15 ns/div (Zoom display)
Max. record length	Standard	500 Mpts (MW) /50 Mpts (MW) (16 ch)	100 Mpts/module (Internal Memory) 20 Gpts/module (SD Card)	50 MW/ch (Single Trigger Mode)
	Optional	4 Gpts (GW) /500 Mpts (MW) (16 ch)	—	—
Storage	Standard	SD memory card slot	SD memory card slot	—
	Optional	Internal SSD 512 GB Storage for flash acquisition 160 GB	—	Internal HDD 500 GB
Interface	Standard	USB3.0/Ethernet (1000BASE-T)	USB2.0/Ethernet (100BASE-TX/10BASE-T)	USB2.0
	Optional	10 Gbps Ethernet	—	Ethernet (1000BASE-T)
Others	Optional	<ul style="list-style-type: none"> 21 types of plug-in modules IRIG interface GPS interface User-defined math function Real time math function Probe power (4-output or 8-output) Power math function 	<ul style="list-style-type: none"> 18 types of plug-in modules Vehicle Edition GPS unit (separately sold accessory) 	<ul style="list-style-type: none"> 13 types of plug-in modules Probe power (4-output) Without Xviewer With the Xviewer Math Edition (1 license) (701992-GP01)
Power supply		AC	Battery/AC (adapter)/DC (10 V to 30 V)	AC
Display (TFT LCD)		12.1-inch color XGA (capacitive touch screen)	8.4-inch color SVGA (resistive touch screen)	—
External dimensions W × H × D		375 × 259 × 202 mm	305 × 217 × 92 mm	319 × 154 × 350 mm
Weight		Approx. 7.5 kg ³	Approx. 3.9 kg ⁴	Approx. 6.0 kg ³

*1: See each product catalog for more detailed specifications *2: Depends on input module *3: Plug-in modules are not included

*4: When the DL350 equipped with the battery and 2 pieces of 720254. *5: The GPS unit can only be supplied to countries where it is not prohibited by local radio laws.

Plug-in Module Selection Guide**

Input	Model No.	Sample rate	Resolution	Bandwidth	Number of channels	Isolation	Maximum measurement voltage ^{†1} (DC + ACpeak)	DC accuracy	Note
Analog Voltage	720212 ⁹	200 MS/s	14 bit	40 MHz	2	Isolated	1000 V ² , 200 V ⁵	±0.5%	High speed, high voltage, isolated
	720211 ⁹	100 MS/s	12 bit	20 MHz	2	Isolated	1000 V ² , 200 V ⁵	±0.5%	High speed, high voltage, isolated
	720250	10 MS/s	12 bit	3 MHz	2	Isolated	800 V ² , 200 V ⁵	±0.5%	High noise immunity
	701251	1 MS/s	16 bit	300 kHz	2	Isolated	600 V ² , 140 V ⁵	±0.25%	High sensitivity range (1 mV/div), low noise (±100 µVtyp.), and high noise immunity
	720256	10 MS/s	16 bit	3 MHz	4	Isolated	600 V ² , 200 V ⁵	±0.25%	4 CH BNC input low noise, high noise immunity
	720254	1 MS/s	16 bit	300 kHz	4	Isolated	600 V ² , 200 V ⁵	±0.25%	4 CH BNC input low noise, high noise immunity
	701255	10 MS/s	12 bit	3 MHz	2	Non-Isolated	600 V ⁴ , 200 V ³	±0.5%	High speed, non-isolated
	720268	1 MS/s	16 bit	300 kHz	2	Isolated	1000 V ¹⁰	±0.25%	With AAF, RMS, and high noise immunity
Analog Voltage & Temperature	720220	200 kS/s	16 bit	5 kHz	16	Isolated (GND-terminal) non-isolated (CH-CH)	20 V ³	±0.3%	16 CH voltage measurement (Scan-type)
	701261	100 kS/s (Voltage), 500 S/s (Temperature)	16 bit (Voltage), 0.1°C (Temperature)	40 kHz (Voltage), 100 Hz (Temperature)	2	Isolated	42 V	±0.25% (Voltage)	Thermocouple (K, E, J, T, L, U, N, R, S, B, W, KP/AuFe)
	701262	100 kS/s (Voltage), 500 S/s (Temperature)	16 bit (Voltage), 0.1°C (Temperature)	40 kHz (Voltage), 100 Hz (Temperature)	2	Isolated	42 V	±0.25% (Voltage)	Thermocouple (K, E, J, T, L, U, N, R, S, B, W, KP/AuFe), with AAF
	701265	500 S/s (Voltage), 500 S/s (Temperature)	16 bit (Voltage), 0.1°C (Temperature)	100 Hz	2	Isolated	42 V	±0.08 (Voltage)	Thermocouple (K, E, J, T, L, U, N, R, S, B, W, KP/AuFe), high sensitivity range (0.1 mV/div)
	720266	125 S/s (Voltage), 125 S/s (Temperature)	16 bit (Voltage), 0.1°C (Temperature)	15 Hz	2	Isolated	42 V	±0.08 (Voltage)	Thermocouple (K, E, J, T, L, U, N, R, S, B, W, KP/AuFe), high sensitivity range (0.1 mV/div), Low noise
Strain	720221 ⁸	10 S/s	16 bit	600 Hz	16	Isolated	20 V	±0.15% (Voltage)	16 CH voltage or temperature measurement (scan method) Thermocouple (K, E, J, T, L, U, N, R, S, B, W, KP/AuFe)
	701270	100 kS/s	16 bit	20 kHz	2	Isolated	10 V	±0.5% (Strain)	Supports strain NDIS, 2, 5, 10 V built-in bridge power supply
Analog Voltage, Acceleration	701271	100 kS/s	16 bit	20 kHz	2	Isolated	10 V	±0.5% (Strain)	Supports strain DSUB, 2, 5, 10 V built-in bridge power supply, and shunt CAL
	701275	100 kS/s	16 bit	40 kHz	2	Isolated	42 V	±0.25% (Voltage) ±0.5% (Acceleration)	Built-in anti-aliasing filter, Supports built-in amp type acceleration sensors (4 mA/22 V)
Frequency	720281	1 MS/s	16 bit	resolution 625 ps	2	Isolated	420 V ² , 42 V ³	±0.1% (Frequency)	Measurement frequency of 0.01 Hz to 500 kHz, Measured parameters (frequency, RPMs, RPSS, period, duty cycle, power supply frequency, pulse width, pulse integration, and velocity)
Logic	720230	10 MS/s	—	—	8 bit × 2 ports	non-isolated	depend on logic probe used.	—	(8 bit/port) × 2, compatible with four types of logic probe (sold separately)
CAN/CAN FD/LIN	720245	100 kS/s	—	—	(60 signals × 2) port	Isolated	10 V (CAN port) 18 V (LIN port)	—	CAN/CAN FD port × 2, CAN/CAN FD Data of maximum 32-bit allowable, LIN port × 2, CAN FD/LIN switchable on each port separately available for DL950/VCE and DL350 /VE option. ^{6,7}
SENT	720243	100 kS/s	—	—	11 data × 2 ports	Isolated	42 V	—	Supported protocol: SAE J2716. ^{6,7}

^{†1}: Probes are not included with any modules. ^{†2}: In combination with 700929, 702902, or 701947 probe. ^{†3}: Direct input ^{†4}: In combination with 10:1 probe model 701940 ^{†5}: In combination with 701901 + 701954. ^{†6}: Any other modules can be installed in the remaining slots. ^{†7}: When using these modules with DL950/VCE or DL850EV, up to four, CAN & LIN Bus Monitor Modules (720241), CAN/CAN FD Monitor Modules (720242), CAN FD/LIN Monitor Module (720245) or SENT Monitor Modules (720243) total can be used on a single main unit. For the CAN & LIN Bus Monitor Modules (720241), CAN/CAN FD Monitor Modules (720242), CAN FD/LIN Monitor Module (720245), up to two in total can be used on a single main unit. ^{†8}: The 16 CH Scanner Box (701953) is required for measurement. ^{†9}: Class 1 Laser Product, See Bulletin DL950-02EN. ^{†10}: In combination with 758933 and 701954. 1000 Vrms (1000 VDC or 1414 Vpeak maximum) when using with DL950 or DL350. 850V (DC + ACpeak) when using with DL850/DL850V/DL850E/DL850EV or SL1000. ^{†11}: See the main specifications for voltage-axis sensitivity setting and measurement range.

Compatibility of the plug-in modules with the main units

Model	Plug-in Module Name	Remark	Main Unit				
			DL950	DL350	DL850E	DL850EV	SL1000
720212	High-speed 200 MS/s 14 Bit Isolation Module		Yes	No	No	No	No
720210	High-speed 100 MS/s 12 Bit Isolation Module	Discontinued	No	No	Yes	Yes	Yes
720211	High-speed 100 MS/s 12 Bit Isolation Module		Yes	Yes	Yes	Yes	Yes
701250	High-speed 10 MS/s 12 Bit Isolation Module	Discontinued	Yes	No	Yes	Yes	Yes
720250	High-speed 10 MS/s 12 Bit Isolation Module		Yes	Yes	Yes	Yes	Yes
701251	High-speed 1 MS/s 16 Bit Isolation Module		Yes	No	Yes	Yes	Yes
720256	4 CH 10 MS/s 16 Bit Isolation Module		Yes	No	No	No	No
720254	4 CH 1 MS/s 16 Bit Isolation Module		Yes	Yes	Yes	Yes	No
701255	High-speed 10 MS/s 12 Bit Non-Isolation Module		Yes	No	Yes	Yes	Yes
701267	High-voltage 100 kS/s 16 Bit Isolation Module (with RMS)	Discontinued	No	No	Yes	Yes	Yes
720268	High-voltage 1 MS/s 16 Bit Isolation Module (with AAF, RMS)		Yes	Yes	Yes	Yes	Yes
720220	16 CH Voltage Input Module		No	Yes	Yes	Yes	No
701261	Universal Module		Yes	Yes	Yes	Yes	Yes
701262	Universal Module (with AAF)		Yes	Yes	Yes	Yes	Yes
701265	Temperature/High-Precision Voltage Module		Yes	Yes	Yes	Yes	Yes
720266	Temperature/High-Precision Voltage Isolation Module (Low Noise)		Yes	Yes	Yes	Yes	Yes
720221	16 CH Temperature/Voltage Input Module		Yes	Yes	Yes	Yes	No
701270	Strain Module (NDIS)		Yes	Yes	Yes	Yes	Yes
701271	Strain Module (DSUB, Shunt-CAL)		Yes	Yes	Yes	Yes	Yes
701275	Acceleration/Voltage Module (with AAF)		Yes	Yes	Yes	Yes	Yes
701281	Frequency Module	Discontinued	Yes	No	Yes	Yes	Yes
720281	Frequency Module		Yes	Yes	Yes	Yes	Yes
720230	Logic Input Module		Yes	Yes	Yes	Yes	No
720240	CAN Bus Monitor Module	Discontinued	Yes	Yes	No	Yes	No
720242	CAN/CAN FD Monitor Module		Yes	Yes	No	Yes	No
720241	CAN & LIN Bus Monitor Module		Yes	Yes	No	Yes	No
720245	CAN FD/LIN Monitor Module		Yes	Yes	No	No	No
720243	SENT Monitor Module		Yes	Yes	No	Yes	No

Note: • Probes are not included with any modules.
• The use of a 720221 module requires an External Scanner Box (model 701953).
• Firmware update may be required depending the module used.

• The /VE option is required when using a 720240, 720241, 720242, 720245, or 720243 module with a DL350.
• The /VCE option is required when using a 720240, 720241, 720242, 720245, or 720243 module with a DL950.
• Refer to the note on Bulletin DL950-02EN page 20 when using a 720254 module with a DL850E or DL850EV.

Powerful Data Acquisition Enables the Research of Dynamic Behavior within Your Application

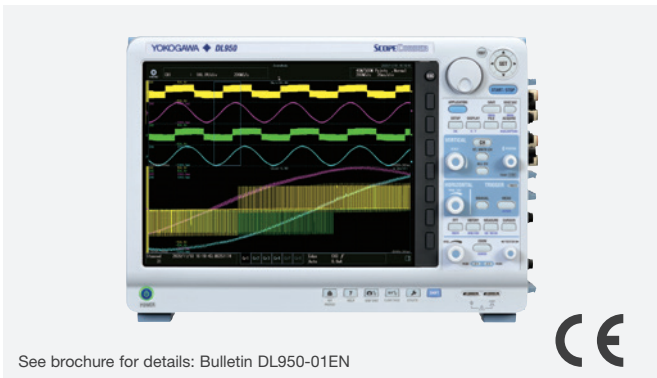

See brochure for details: Bulletin DL950-01EN

Specifications

Max. sampling rate	200 MS/s (720212) ¹
Frequency bandwidth	40 MHz (720212) ¹
Number of channels	Max. 128 ch, Number of slots for the plug-in module: 8
Logic input	Max. 128 bits (When using eight 720230 modules)
A/D conversion resolution	16, 14 or 12 bits ¹
DC accuracy	±(0.5% of 10 div) (720250 and 701255) ¹
Time axis setting	100 ns/div to 20 day/div
Time axis accuracy	±4.6 ppm
Max. record length	Standard: 500 Mpts (MW)/CH /M2 option: 4 Gpts (GW)/CH
Channel-to-channel calculation function	Definable math waveforms 8
Automatic measurement of waveform parameters	Maximum number of displayed parameters 80
Cycle statistical/historic process	Product of number of cycles and parameters 64000
Storage	SD memory card slot (standard) 512 GB internal SSD (option) 160 GB Storage for flash acquisition
Communication interface (standard)	USB 3.0 (standard)/Ethernet 1000BASE-T 10 Gbps Ethernet (option)
Other options	IRIG interface GPS interface User defined computation Real time math computation Power math computation Four/eight probe power outputs
Display	12.1 inch TFT color LCD monitor
Display resolution	1024 × 768 pixels (XGA)
External dimensions	375 (W) × 259 (H) × 202 (D) mm (excluding handle and protrusions)
Weight	Approx. 7.5 kg to 10 kg (varies depending on the types and the number of modules used)

¹: Varies depending on the module.

Overview

A ScopeCorder is a powerful portable data acquisition recorder that can capture and analyze both transient events and trends for long time. Using flexible modular inputs it combines the measurements of electrical and physical (sensor) signals, such as from CAN/CAN FD, LIN, SENT and is also able to trigger on electrical power related calculations in real-time.

Flexible Inputs with Built-in Signal Conditioning

Choose from up to 21 input modules and gain a thorough insight into any application by synchronizing the measurement of multiple parameters.

- Voltage and Current
- Sensor Outputs
- Temperature, Vibration /Acceleration, Strain, Frequency
- Logic Signals & CAN/ CAN FD/LIN and SENT

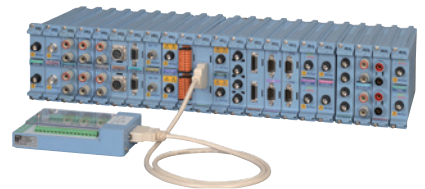

Large (8 Gpoint) memory offers long duration measurement and two instantaneous zoom locations – 8 GPoint memory (/M2 option*) –

Comes standard with 1 Gpoints of memory, expandable with 4 or 8 GPoint options.

Large capacity memory does not only simply provide longer durations of measurement, but also higher sampling rate at the same measurement time or multi-channel at the same sampling rate.

*Memory allocated to 1-CH is up to 4 G points.

10 GE data transfer (/C60 option)

Using 10 Gbps Ethernet, up to 20 MS/s of data can be stored in real time on a PC. An SFP+ module, a fiber optic cord, and the PC software IS8000 are used for data transfer.

*Please use a commercially available SFP+ module and a 10 GE fiber optic cord.

*When transferring files, high speed transfer is not possible.



SSD recording and Flash Acquisition

In addition to SSD recording, which provides recording to 512 GB internal SSD with up to 2 MS/s, Flash Acquisition provide long time recording to internal Flash memory with up to 20 MS/s.

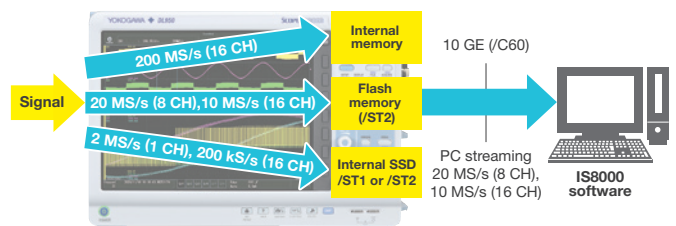

Multi-unit synchronization of up to 160-CH (/C50 option)

The number of channels can be extended up to 160 by connecting up to 4 sub units to a single main unit with optical fiber cords. You can synchronize measurement start/stop of the sub units from the main unit.

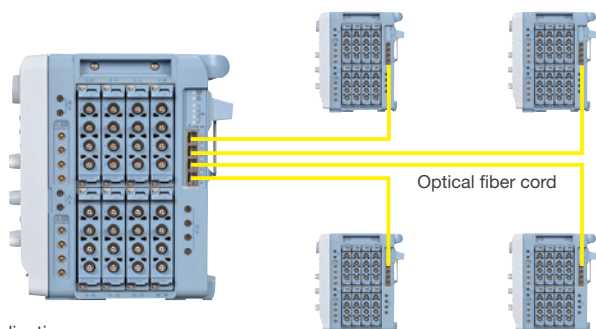

Applications

- Battery cell evaluation
 - Multi-point vibration analysis
 - Multi-point strain test
- *Please use the Optical Transceiver Module 720941 and the Optical Fiber Cord 720942.

Time synchronization IEEE1588/IRIG and GPS

Time synchronization with IEEE1588 signals is available. With the /C40 option, the DL950 can output IEEE1588 master signals. Time synchronization using IRIG and GPS is also available (/35 option).

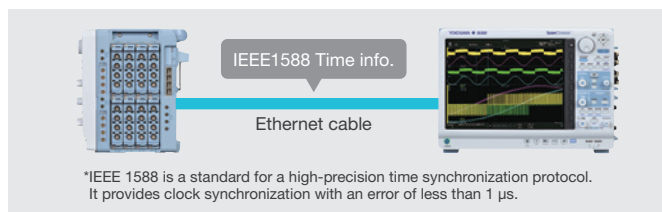

Easy access to frequently used applications

Touch an application icon, then the graphical setup screen for the application appears. You can register your frequently used applications as your favorite.



Power and harmonics analysis (/G05 option)

Evaluation of a system in which motors are driven by batteries, such as an EV, can be completed by a single DL950 unit. It calculates the conversion efficiency from the input and output power of the inverter and analyzes the effects of harmonics caused by external disturbances while capturing mechanical variations in motor speed and torque.

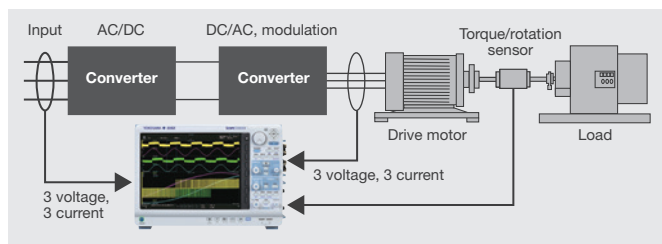

In-vehicle data measurement solution

The DL950 /VCE option provides enhanced features and functions mainly for vehicle development and evaluation. Supporting

CAN FD/LIN Monitor Module (720245) and SENT Monitor Module (720243), the DL950 can display each protocol communication data of in-vehicle networks as trend waveforms on the monitor. Also, it can trigger on decoded waveforms.

Comparative verification between measured signals and CAN and CAN FD bus signals

The CAN/CAN FD bus data and related waveforms can be viewed on the same screen. For example, you can check an ignition switch ON/OFF signal, a CAN FD signal corresponding to that command, and pressure signals on the same screen to verify the correlation between them.



Model and Suffix Code

Model	Suffix Code	Description
DL950		ScopeCorder, 1 G Points memory ¹
Power cord	-D	UL/CSA standard and PSE compliant
	-F	VDE/Korean standard
	-R	Australian standard
	-Q	British standard
	-H	Chinese standard
	-N	Brazilian standard
	-T	Taiwanese standard
	-B	Indian standard
	-U	IEC Plug Type B
Language	-HJ	Japanese menu and panel
	-HE	English menu and panel
	-HC	Chinese menu and panel
	-HK	Korean menu and panel
	-HG	German menu and panel
	-HF	French menu and panel
	-HL	Italian menu and panel
	-HS	Spanish menu and panel
	-HR	Russian menu and panel
Option	/M1 ²	Memory expansion to 4 G Points ⁷
	/M2 ²	Memory expansion to 8 G Points ⁸
	/ST1 ³	Internal storage (512 GB)
	/ST2 ³	Internal storage (512 GB) + Flash Acquisition function
	/C35	IRIG and GPS interface
	/C40	IEEE1588 Master function
	/C50	Multi-unit synchronization interface
	/C60	10 Gbps Ethernet interface
	/G02	User-defined math function
	/G03 ⁴	Real time math function
	/G05 ⁴	Power math function (including Real time math function)
	/P4 ⁵	Four probe power outputs
	/P8 ⁵	Eight probe power outputs
	/VCE	Vehicle edition

Standard Main Unit Accessories

Power cord, front cover, panel sheet, 8 slot cover panels, user's manuals⁵

¹: The main unit requires plug-in module (s). Max. 500 M Points/CH. ²,³,⁴,⁵: Only one of these can be selected. ⁶: The Start Guide is provided as a printed document and other manuals on a CD-ROM. ⁷: Max. 2 G Points/CH ⁸: Max. 4 G Points/CH

Additional option license for DL950*

Model	Suffix Code	Description
709831	-C40	IEEE1588 Master function
	-G02	User-defined math function
	-G05	Power math function (including Real time math function) / G03 is necessary to add /G05
	-VCE	Vehicle edition

*Separately sold license product (customer-installable).

The Most Comprehensive Fully Portable Measuring Instrument Available for Capturing, Displaying, Recording and Analyzing



See brochure for details: Bulletin DL350-01EN

Specifications

Sampling rate	up to 100 MS/s (720211) ¹
Frequency bandwidth	up to 20 MHz (720211) ¹
Number of channels	up to 8 ch (isolated), 32 ch (non-isolated) ¹
Number of slots for the plug-in module	2
Built-in logic input	16 bits
A/D conversion resolution	16 or 12 bits ¹
DC accuracy	±0.25% of 10 div. (720254) ±0.50% of 10 div. (720211) ¹
Time axis accuracy	±0.001%
Record length	Up to 100 Mpoint/module (For internal memory) Up to 20 Gpoint/module (For SD memory card)
Analysis function	T-Y, X-Y, FFT and Harmonic analysis
Auxiliary I/O	External Clock Input, Trigger Input/Output, GO/NO-GO Output, External Start/Stop Input, Event Input, Probe-Compensation-Signal Output and GPS Input
Communication interfaces	USB 2.0 (standard) Ethernet 100 BASE-TX/10 BASE-T (standard)
Storage destination	SD memory card, USB storage
Display	8.4-inch color TFT LCD (resistive touch screen)
Display resolution	800 × 600 pixels (SVGA)
Operating temperature	0 to 45°C (with battery/DC power)
Power Supply	AC adapter (720921), DC power (720922) or battery pack (EB option or 739883)
Battery pack operation time	Approx. 3 hours
External dimensions	Approx. 305 (W) × 217 (H) × 92 (D) mm (excluding handle and protrusions)
Weight	Approx. 3.9 kg (When the DL350 equipped with the battery and 2 pieces of 720254)
Major accessories	702902 10:1 Probe 701947 100:1 Probe 720930 Clamp-on probe (up to AC 50 A) 720931 Clamp-on probe (up to AC 200 A) 720912 Logic probe (TTL level/contact input/3 m) 93050 Carrying case 720940 GPS unit ²

¹1: Varies depending on the module.

²2: The GPS unit can only be supplied to countries where it is not prohibited by local radio laws.

Overview

The DL350 ScopeCorder combines in one compact instrument all the measurement and recording capabilities you need when you are away from your office or lab. High-speed signals or long-term recording, 'quick and simple' or sophisticated operation, the DL350 provides the flexibility you need when you need it.

Complete self-contained signal conditioning

This extraordinary input capability is achieved by providing 2 slots, which can be populated with any of 18 different types of user swappable input modules. This means, for example, that user-swappable 4 isolated 16-bit voltage inputs can be measured at 1 MS/s, alongside 16 temperatures or 2 separate CAN or LIN buses each containing 30 signals. Swap a module and measure at 100 MS/s with 12 bits of resolution and 1 kV of isolation. Meanwhile there are 16 built-in logic inputs; swap in a digital input module to add even more. Make AC measurements like a DMM with an RMS module in real-time or use a math channel after the recording is finished.

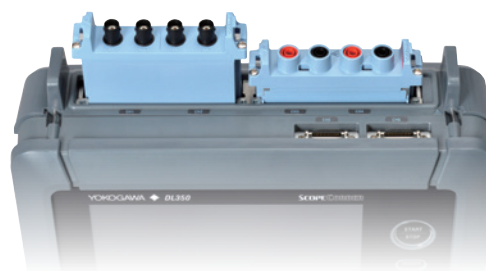

Intuitive operation

An 8.4 inch resistive touch screen has been adopted in order to deliver superior noise free performance. In environments with the highest levels of electrical noise such as motors and inverters, measurement precision is maintained whilst enabling the unit to be operated by using (gloved) fingers or stylus.



A wealth of triggers for fault finding

The user has a choice of a simple level trigger or can use enhanced triggers such things as pulse width, waveform period and across multiple channels. For example, the wave window trigger is ideal for AC power line monitoring which enables voltage sags, surges, spikes, phase shifts or drop outs to be easily captured (available for 40 to 1000 Hz waveforms).

Leave a DL350 unattended and automatically save the waveform to a file, or send a notification email, if and when it triggers.

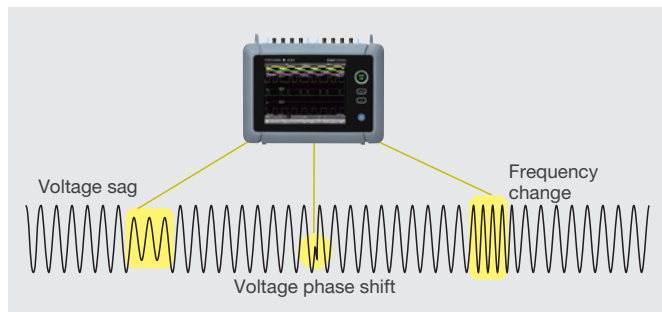

CAN/CAN FD bus, LIN bus and SENT monitoring

Use the DL350 with /VE option and bus monitor module to decode CAN/CAN FD bus, LIN bus or SENT signals and display information such as engine temperature, vehicle speed and brake pedal position as trend waveforms and compare this with the analog data coming from the actual sensors. This enables automotive engineers to gain an insight into the dynamic behavior of the complete electromechanical system.

Position and global timing using GPS

An optional GPS unit* enables latitude, longitude, altitude, speed and motion direction data to be synchronized with the waveform data, perfect for drive testing, mobile testing, or distributed field recordings.

*The GPS unit can only be supplied to countries where it is not prohibited by local radio laws.

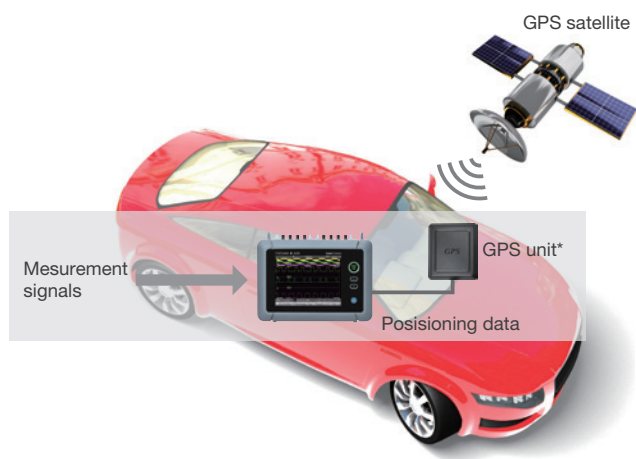

Mains, DC or rechargeable battery power

The built-in rechargeable battery provides 3 hours of continuous operation for mobile measurements or can serve as a backup power supply if the main DC power is disconnected. This makes the DL350 a highly reliable ScopeCorder for tests which are difficult or expensive to repeat.

Operates in freezing temperatures

Even when used with the rechargeable battery, the DL350 will operate in temperatures from 0 to 45 degrees. The DL350 brings high-quality laboratory measurements into the harsh environments of the field.



Assistant software (Free Software)

Data files or setup configuration files stored in the DL350 SD card can be backed up with the press of a button.

Remote setting, start-stop control and setup file editing can also be easily done on the connected PC.

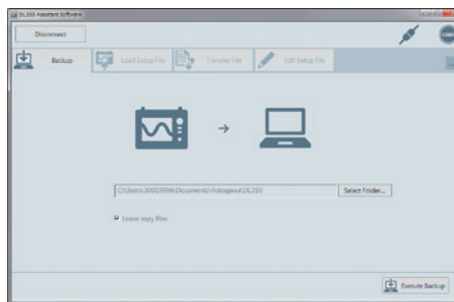

Model and Suffix Code

Model	Suffix Code	Description
DL350		DL350 ScopeCorder (Plug-in modules and AC adapter are not included.)
Languages	-HJ	Japanese menu
	-HE	English menu
	-HC	Chinese menu
	-HK	Korean menu
	-HG	German menu
	-HF	French menu
	-HL	Italian menu
	-HS	Spanish menu
	-HR	Russian menu
Options	/VE	Vehicle Edition
	/EB	Battery pack + Battery pack cover
720921		60 W AC Adapter AC adapter (Separate purchase) is required to charge the battery and operate the main unit.
Power cord	-D	UL/CSA Standard
	-F	VDE/Korean Standard
	-Q	BS/Singapore Standard
	-H	GB Standard
	-T	BSMI Certification
	-N	NBR Standard

Standard accessories: Hand strap, Slot cover panel (2), User's manual

DC power cable and Battery Pack Accessories

Model	Suffix Code	Description
720922		DC power cable (Cigarette lighter plug Type)
739883		Battery Pack ¹ , ² , ³
720923		Battery Pack Cover ³

¹: AC adapter (720921) is required for charging battery.

²: Operation of the battery pack (739883) requires the battery pack cover (720923)

³: Included in the /EB option.

Additional Option License*¹

Model	Suffix Code	Description
709830	-VE	Vehicle Edition

*¹: Separately sold license product (customer-installable).

Fast Acquisition, Transfer, and Storage High-Performance Data Acquisition Unit



See brochure for details: Bulletin 7201-20E

Specifications

Plug & Play	Auto-recognition of units and modules		
Input type	Plug-in module (A/D converters built in to each unit)		
Maximum number of input channels	16 (One unit operation)		
	128 (8 units synchronous operation)		
Maximum sample rate	100 MS/s on all channels		
Measuring mode	Free Run and Triggered		
Clock source	Internal and external		
Maximum record length (internal memory)	In Free Run mode	1 module: 32 MW/ch	
		2 modules: 16 MW/ch	
		3 to 4 modules: 8 MW/ch	
		5 to 8 modules: 4 MW/ch	
Maximum record length (internal memory)	In Single Trigger mode	1 module: 50 MW/ch	
		2 modules: 25 MW/ch	
		3 to 4 modules: 10 MW/ch	
		5 to 8 modules: 5 MW/ch	
Measuring groups	Up to 4 groups definable with independent sample rates		
Trigger mode	Normal, Single, and Single(N)		
Trigger source	Input channel, External, LINE, Time		
Record conditions	For Free Run mode	Immediate, abs. time, time divided, alarm, and external trigger	
	For Trigger mode	Each trigger	
Internal hard disk	500 GB (with the /HD1 option)		
Maximum real-time hard disk recording speed	Internal hard disk 1.6 MS/s (= 200 kS/s × 8 ch = 100 kS/s × 16 ch)		

Maximum measuring time (unit: seconds) at Single triggered measurement

Sampling rate	Number of Measuring Channels			
	2 ch	4 ch	8 ch	16 ch
100 MS/s	0.5	0.25	0.1	0.05
50 MS/s	1	0.5	0.2	0.1
10 MS/s	5	2.5	1	0.5
1 MS/s	50	25	10	5
500 kS/s	100	50	20	10
200 kS/s	250	125	50	25
1 kS/s	50000	25000	10000	5000

Features

Fast Acquisition

- Up to 100 MS/s on all channels (10 ns sampling interval)
- Supports parallel testing: Perform measurements with up to four simultaneously independent sample rates

Fast Transfer and Storage

- Stream data to PC via high speed USB 2.0 or 1000BASE-T Gigabit Ethernet
- Stream data to a PC hard disk or the SL1000's internal hard disk in real time (at speeds of 1.6 MS/s = 100 kS/s × 16 ch)^{*1}
- Maximum 8 synchronized units

*1: Speed depends on PC performance and measuring conditions.

Easy to use

Easy to use Standard Acquisition Software

Max. 128 ch Synchronized (16 ch × 8 units)

Data files recorded by multiple units, in synchronized mode, are all linked together by a common LINK file, thereby facilitating batch processing. Using this LINK file, data from all units can be processed and analyzed, as one, at the same time.

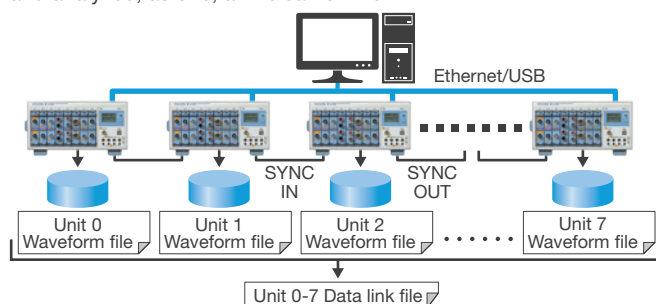

Stand-Alone Recording

Normally, SL1000 is controlled by PCs. However, SL1000 can record data even without PCs (/HD1 option is required).

This stand-alone recording function is useful for the measurement in the severe environment.

Model and Suffix Code

Model	Suffix Code	Description
720120		SL1000 High-Speed Data Acquisition Unit ^{*1} Including Xviewer Standard Edition (1 license) (701992-SP01)
Power Cord	-D	UL and CSA standard
	-F	VDE standard
	-R	AS standard
	-Q	BS standard
	-H	GB standard (Complied with CCC)
Options	/HD1	Internal 500 GB HDD
	/C10	Ethernet interface
	/P4	Probe power (4-output)
	/XV0	Without Xviewer
	/XV1	With the Xviewer Math Edition (1 license) (701992-GP01)

*1: Plug-in modules and PC not included with the SL1000.

Model	Description
720211	High-speed 100 MS/s 12-Bit Isolation Module (2 ch)
720250	High-speed 10 MS/s 12-Bit Isolation Module (2 ch)
701251	High-speed 1 MS/s 16-Bit Isolation Module (2 ch)
701255	High-speed 10 MS/s 12-Bit non-Isolation Module (2 ch)
720268	High-voltage 100 kS/s 16-Bit Isolation Module (with AAF, RMS, 2 ch)
701261	Universal Module (2 ch)
701262	Universal Module (with Anti-Aliasing Filter, 2 ch)
701265	Temperature/High-precision voltage Module (2 ch)
720266	Temperature/High-precision voltage Module (2 ch)
701275	Acceleration/Voltage Module (with Anti-Aliasing Filter 2 ch)
701270	Strain Module (NDIS, 2 ch)
701271	Strain Module (DSUB, Shunt-CAL, 2 ch)
720281	Frequency Module

Model	Description
720901-01	Synchronized connection cable for SL1000 (1 m)
720901-02	Synchronized connection cable for SL1000 (3 m)
751541-E4	Rack mounting kit for EIA standard
751541-J4	Rack mounting kit for JIS standard

Easy to Use

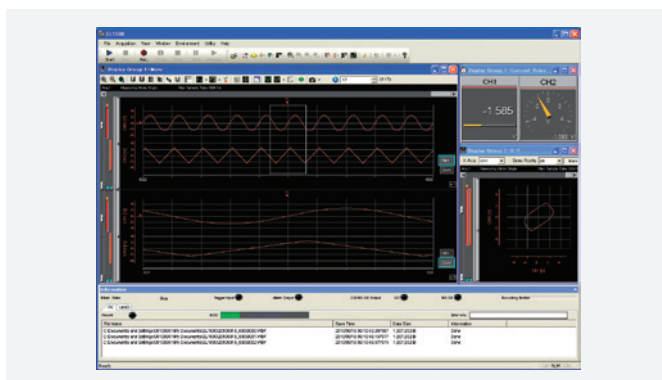

Specifications

Plug and Play	Auto-recognition of units and modules
Measurement modes	Free Run and Triggered
ACQ modes	Normal, envelope, and box average
Clock sources	Internal and external
Measurement groups	Up to 4 groups definable with independent sample rates
Trigger modes	Normal, single, and single(N)
Trigger sources	CH1-CH16, LINE, Time, and External
Other trigger functions	Combination trigger, hold-off, pretriggers, and trigger delay
Save conditions	Manual operation, or based on time, or alarms
Other save functions	Manual save (file division), specify no. of saves, save all data in memory, and save simultaneously to PC's hard disk and SL1000's internal hard disk (with /HD1 option)
Save format	Binary data file (original, *.wdf)
Waveform data	Binary data file(s) can be converted to ASCII
Conversion (Xviewer)	(* .csv) or Excel (*.xls) format
Maximum speed for saving in real time	PC hard disk: 1.6 MS/s (= 100 kS/s × 16 channels) ^{*1}
Waveform monitor	Trend display (displays measured waveforms of different sample rates simultaneously) ^{*2} , and instantaneous value displays (digital, bar graph, meter, and thermometer)
X-Y display	X-axis channel settings, selection of main or zoomed waveform (in Triggered mode), and selection of the number of data points to draw (2 K, 10 K, 100 K)
Mark display (Free run mode)	Setting of marks (up to 128 marks, each mark can display up to 16 characters), display color setting, mark editing, deletion of marks, mark list, collectively saving mark data with the same file name as the waveform data, and loading mark data into Xviewer.
Accumulation display	Accumulates T-Y and X-Y waveforms
Snapshot	Waveform that is currently being displayed can be retained on the screen as a snapshot waveform. Display color setting and snapshot waveform deletion
Display groups	Up to 4 display groups
Other display functions	History waveform, arbitrary axis divisions, and horizontal axis scaling + specifiable units (external clock)
Waveform analysis	Cursor and parameter measurement ^{*3}
Offline waveform computation (with /XV1 option)	Max. Number of displayed waveforms (CHs) 10 waveforms (Math1 to Math 10)
Operations	+, -, ×, /, trigonometry, differentiation/integration, FFT, and others
Alarms	Channel (alarm display and alarm history analysis) ^{*4} , system alarm, and alarm output
GO/NO-GO determination ^{*3}	Waveform parameter judgment and judgment output

System requirements

OS	Windows 7 (32 bit/64 bit)/Windows 8.1 (32 bit/64 bit)/ Windows 10 (32 bit/64 bit)
CPU	Core 2 Duo 2 GHz or better
Memory	1 GB or more
Hard disk	500 MB or more of free space (40 GB or more when using the auto-save function)
Communication interfaces	USB 2.0/Ethernet 1000BASE-T (with /C10 option)
Display	XGA or better, Color: 65536 colors or better
Other	CD-ROM drive and mouse

*1: Typical values. Actual values depend on PC performance and measurement conditions.
*2: When the measurement mode is Free Run, the trigger mode is Single(N), and the number of measurements is Infinite, there may be a limit to the number of channels that can be trend-displayed during measurement. *3: Triggered measurement *4: Free Run measurement

Intuitive Operation

Setup Wizard Makes It Easy

The four screens of the Setup Wizard guide you easily through detailed settings for configuring the system, measuring, saving, and displaying. You can save and recall your settings at any time.

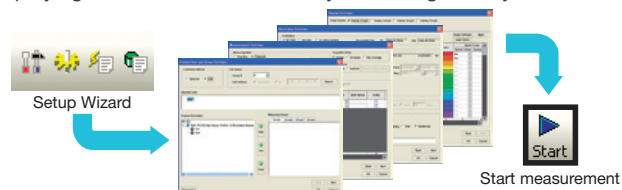

Control Buttons—Just Like Your DVD Remote

Measurement and saving can be started and stopped using the same familiar buttons found on a DVD remote control. Start using the instrument on the same day you receive it, with absolutely no programming required.

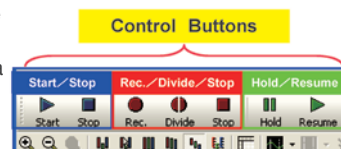

Displaying X-Y Waveforms

You can view both T-Y waveform display and X-Y waveform display. Using its fast update feature, you can evaluate data quickly and easily.

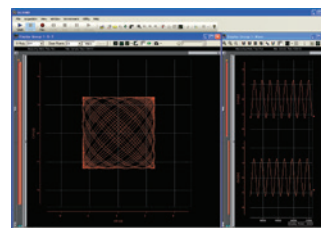

Accumulating Waveforms

Using the accumulation feature, you easily view unevenness of repetitive data.

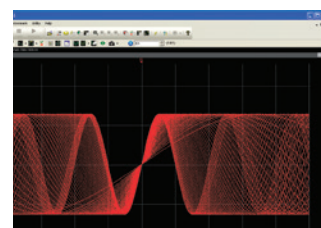





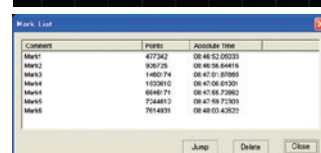













Setting Marks

You can enter comments in the Mark area when monitoring over long periods of time (Free Run mode).



Waveform Measuring ScopeCorder Accessories

Product	Model No.	Description ^{*1}	
10:1 Probe	702902	Wide temperature range, for isolated BNC input -40 to +85°C, DC to 60 MHz, 1000 Vpk-CAT II	
	700929	For Isolated BNC Input 1000 Vpk-CAT II	
Current Probe	701917	5 Arms, DC to 50 MHz, High-sensitivity	
	701918	5 Arms, DC to 120 MHz, High-sensitivity	
	701933	30 Arms, DC to 50 MHz, supports probe power	
	701930	150 Arms, DC to 10 MHz, supports probe power	
	701931	500 Arms, DC to 2 MHz, supports probe power	
	701932	30 Arms, DC to 100 MHz, supports probe power	
	702915	30 Arms, 5 Arms, 0.5 Arms (changeable), DC to 50 MHz, supports probe power	
	702916	30 Arms, 5 Arms, 0.5 Arms (changeable), DC to 120 MHz, supports probe power	
Clamp-on Probe	720930	AC 50 Arms	
	720931	AC 200 Arms	
Probe Power Supply	701934	Supply (4 outputs), large current output, external probe power	
1:1 Safety BNC Adapter Lead (in combination with followings)	701901	1000 Vrms-CAT II	
Pinchers Tip (Hook type)	758928	1000 Vrms-CAT III, 1 set each of red and black	
Large Alligator-Clips (Dolphin type)	701954	1000 Vrms-CAT II, 1 set each of red and black	
Alligator Adapters	758922	300 Vrms CAT II, 1 set each of red and black	
Alligator Adapters	758929	1000 Vrms CAT II, 1 set each of red and black	
Fork Terminal Adapters	758921	1000 Vrms CAT II, 1 set each of red and black	
Passive Probe (10:1) ^{*2}	701940	Non-isolated 600 Vpk	
1:1 BNC-Alligator Cable	366926	Non-isolated 42 V or less, 1 m	

*1: Actual allowable voltage is the lower of the voltages specified for the main unit, probe and cable.

*2: 42 V is safe when using the 701940 with an isolated type BNC input.

Module and accessory combinations

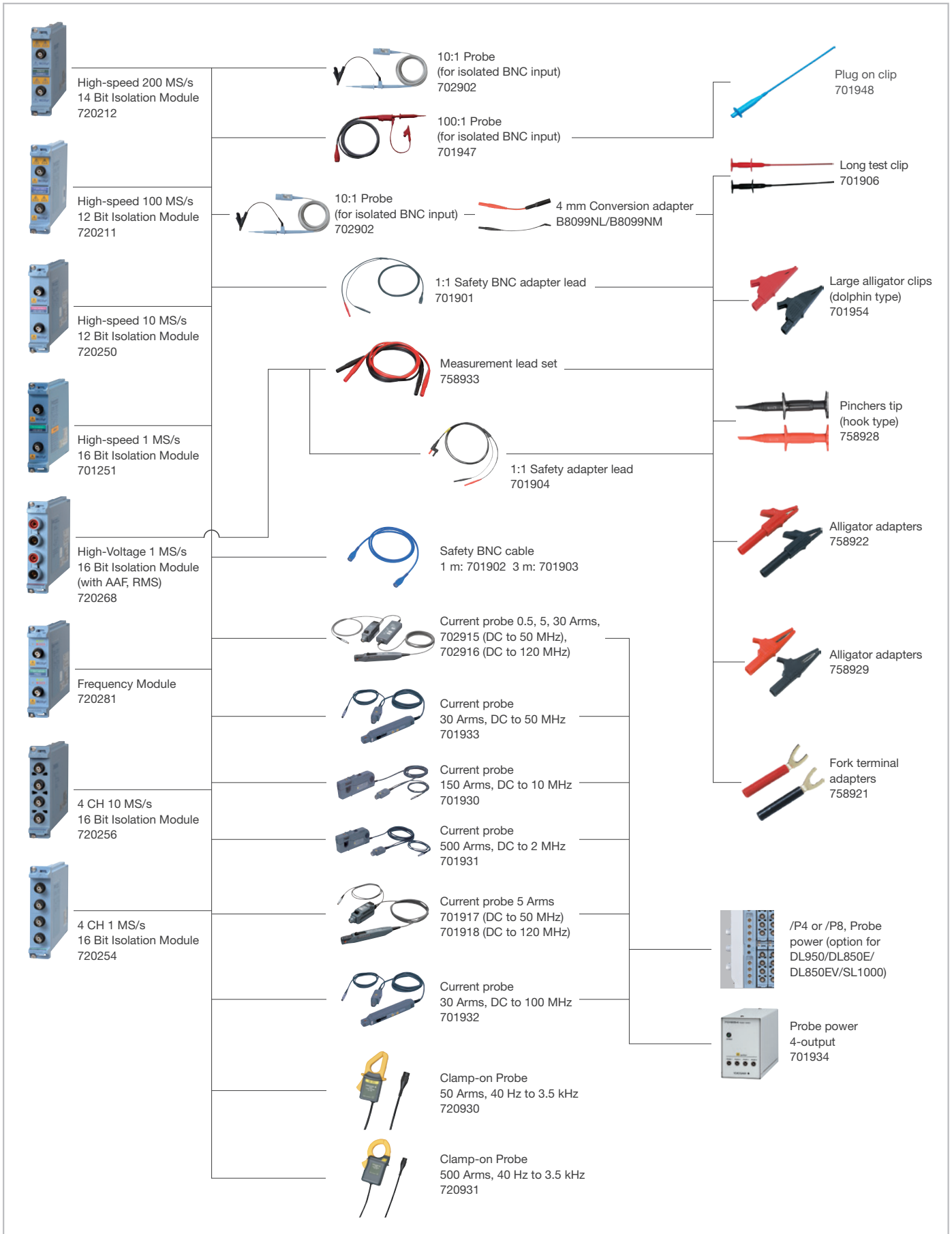

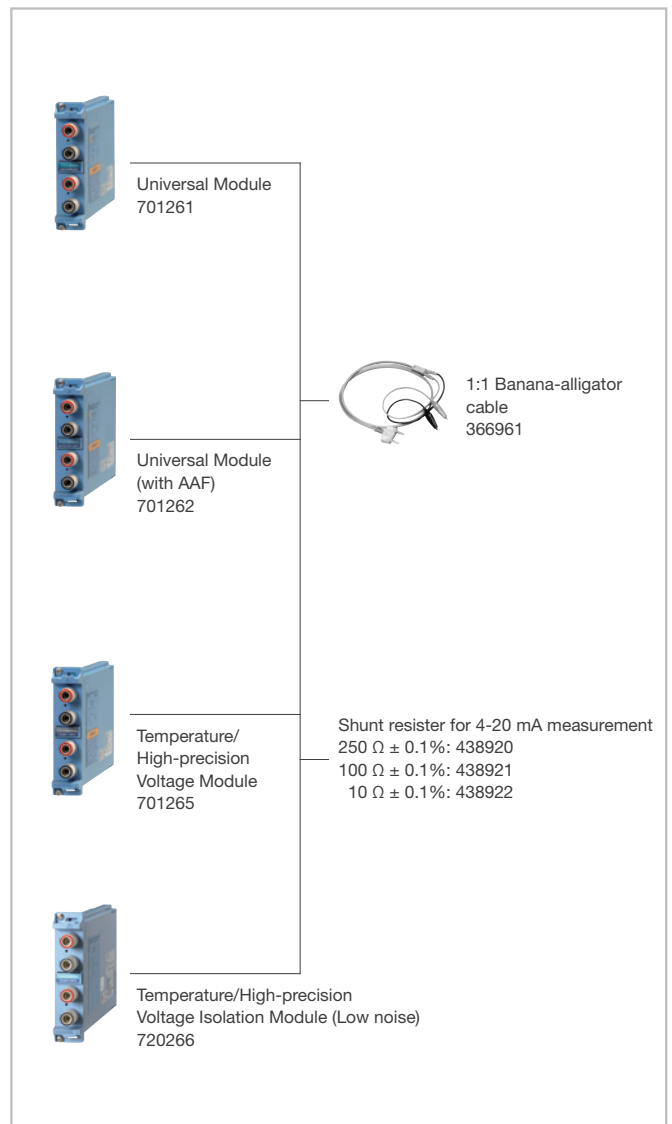
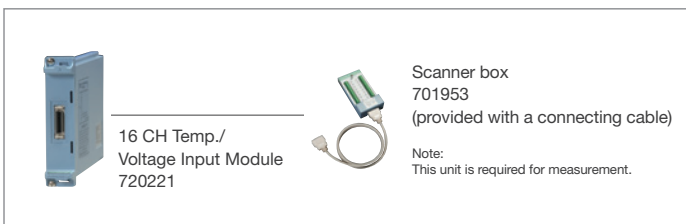
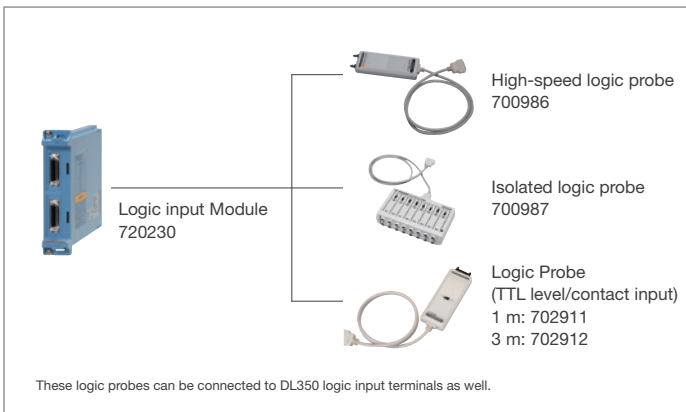
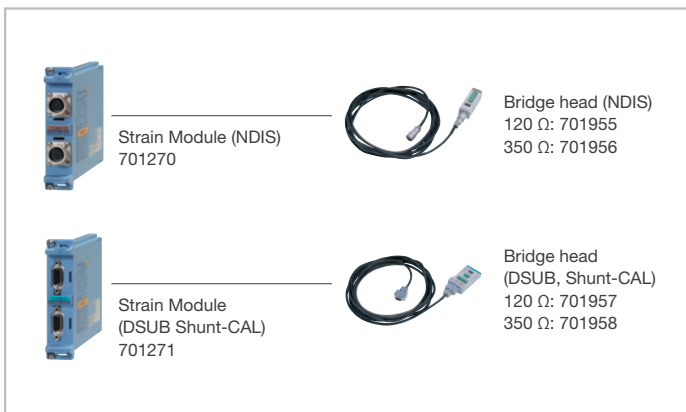
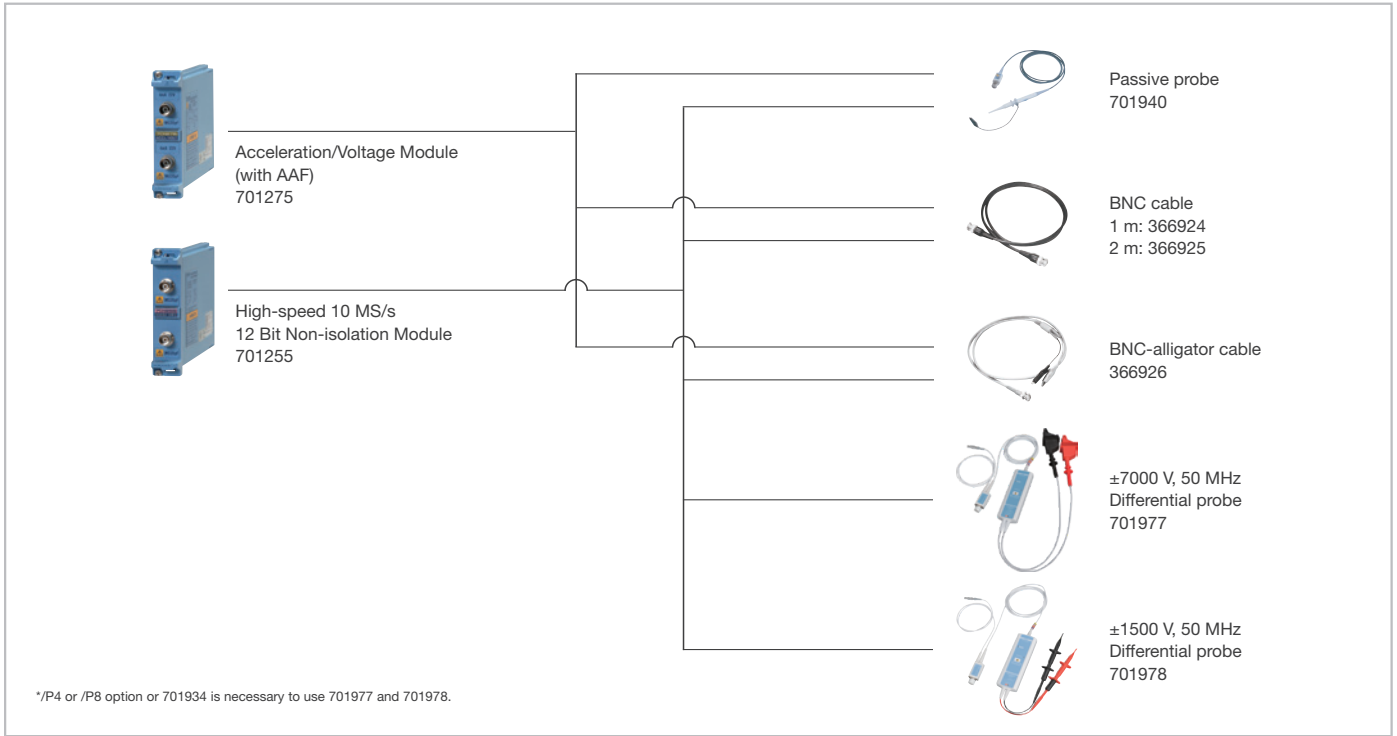

High Definition and Mixed Signal Oscilloscopes Selection Guide*1

The DLM series digital oscilloscopes have high-speed sampling and a wide range of bandwidths that can be utilized for design and development of electronic devices. They can also execute computations on repetitive waveforms and automatically extract waveform parameters. The DLM series offers an extensive selection of digital oscilloscopes with large-capacity memories, powerful triggering functions, unique History function and built-in printers. It also can save and load data to and from internal or external media.

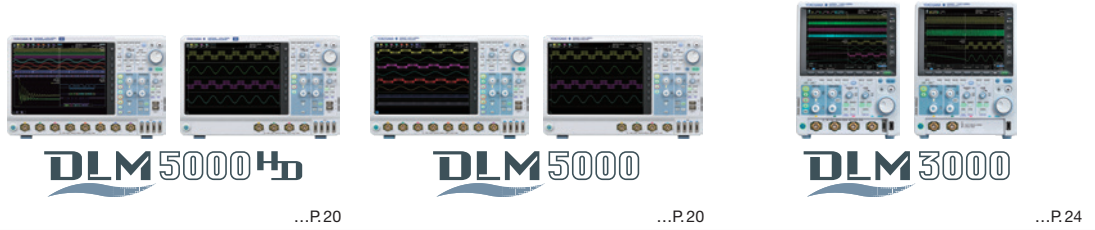

Product Type/Model		High Definition Oscilloscope DLM5000HD Series	Mixed Signal Oscilloscope DLM5000 Series	Mixed Signal Oscilloscope DLM3000 Series
Item				
Features		<ul style="list-style-type: none"> Inheriting the operability and functionality of DLM5000, and 12-bit high resolution anytime Long memory up to 1 G points Fast startup in about 12 seconds Supports various analysis functions of the DLM5000 (optional) Supports clock master function for IEEE 1588 time synchronisation 	<ul style="list-style-type: none"> Analog 8 ch + Logic 32 bits/Analog 4 ch + Logic 32 bits Long memory UART, I²C, SPI, CAN, CAN FD, LIN, CXPI, PSi5, FlexRay and SENT bus analysis functions Power supply analysis functions Large display 	<ul style="list-style-type: none"> Compact & lightweight Analog 4 ch/Analog 3 ch + Logic 8 bits Long memory UART, I²C, SPI, CAN, CAN FD, LIN, CXPI, PSi5, FlexRay and SENT bus analysis functions Power supply analysis functions
Max. sampling rate		2.5 GS/s (All channels)		
Bandwidth		500 MHz ^{*2}		
Number of analog input channels		DLM5038HD, DLM5058HD: 8 DLM5034HD, DLM5054HD: 4	DLM5038, DLM5058: 8 DLM5034, DLM5054: 4	DLM3024, DLM3034, DLM3054: 4 DLM3022, DLM3032, DLM3052: 2
Logic input	Standard	16 bits		DLM3024, DLM3034, DLM3054: Standard 8 bits (included as standard/optionally deletable)
	Optional	32 bits		
Max. vertical sensitivity (1:1)		500 µV/div		
Vertical axis resolution		12 bits	8 bits	
Max. sweep sensitivity		1 ns/div		
Max. record length	Standard	125 Mpoints		
	Optional	500 Mpoints		
Internal storage	Standard	Approx. 1.7 GB		Approx. 300 MB
	Optional	Approx. 64 GB		Approx. 60 GB
Interface	Standard	USB/Ethernet		
	Optional	GP-IB		
Built-in printer	Optional	112 mm width		
Others	Optional	I ² C bus analysis SPI bus analysis CAN, CAN FD, LIN and CXPI bus analysis FlexRay bus analysis SENT analysis UART analysis PSi5 Airbag analysis Probe Power Power Supply analysis functions User-defined math functions Two-unit connection function "DLMsync"		I ² C bus analysis SPI bus analysis CAN, CAN FD, LIN and CXPI bus analysis FlexRay bus analysis SENT analysis UART analysis PSi5 Airbag analysis Probe Power Power supply analysis functions User-defined math functions
Display (TFT LCD)		12.1-inch color XGA (Capacitive touch screen)		8.4-inch color, XGA (Capacitive touch screen)
External dimensions W × H × D		426 × 266 × 180 mm		226 × 293 × 193 mm
Weight		Approx. 7.3 kg		Approx. 4.5 kg

*1: See each product catalog for more detailed specifications.

*2: Depends on model

Common Features of DLM Series

Multichannel

This feature meets the need to measure as many signals as possible simultaneously with one oscilloscope.

DLM3000 series

The DLM3000 series usually functions as 4 channel analog, and is able to switch CH 4 of analog input to 8-bit logic quickly whenever the need arises.

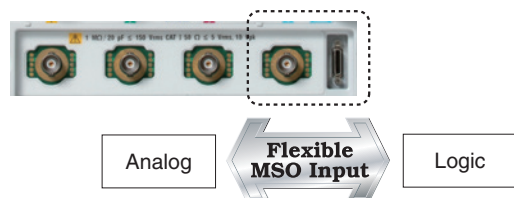

DLM5000HD series, DLM5000 series

Up to 8 channels of analog signals can be measured. Furthermore, up to 16 analog channels and 64 bits of logic can be measured synchronously between two units with a dedicated cable. The dedicated interface is standard on the instrument and is available immediately with an optional additional license. (The DLM5000HD cannot be connected to the DLM5000.)



ScopeCorder Series is available for customers that require more channels for measurement (see page 6).

Long Memory

When the sample rate is increased with oscilloscopes with less memory, the observation time may run out. All of Yokogawa's oscilloscope models are equipped with large capacity memory. For example, the DLM5000HD offers long memory of up to 1 Gpoints for measurement. (Up to 500 Mpoints for the DLM3000 and DLM5000). Even at a fast sample rate of 2.5 GS/s, waveforms for 0.2 seconds can be captured.

The History function that divides the long memory can redisplay past waveforms that have disappeared from the screen.

With the DLM5000HD series, up to 200000 previously captured waveforms can be saved in memory. (Up to 100000 with the DLM3000/DLM5000 series)

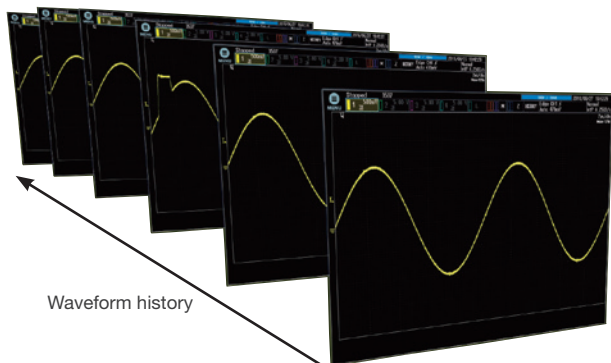

Since a large amount of data is also processed at high speed by dedicated hardware, the long memory can be used comfortably without sacrificing response time.

Connection with a PC

To facilitate the use of a PC, various interfaces such as USB, Ethernet, and GP-IB are available as standard or an option. In addition, various software is available to support remote control, file transfer, and data processing on a PC.

USB memory and peripheral devices, such as keyboard and mouse, can be connected, and connecting to a PC using a USB cable enables it to be used as the external storage of the PC.

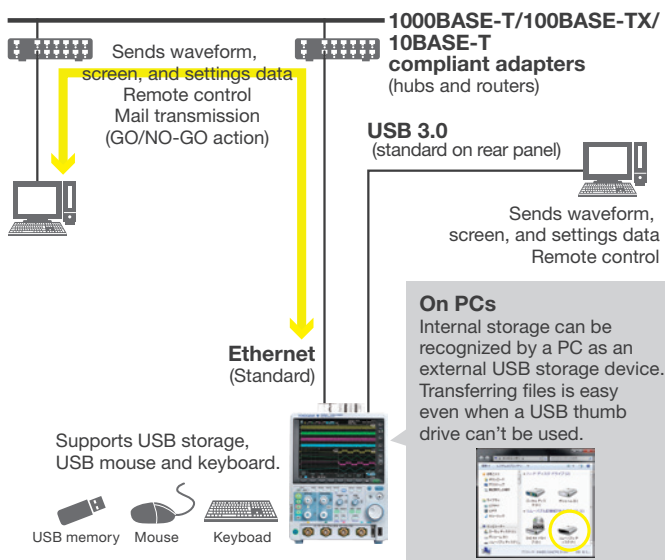

Built-in Printer

With a small built-in printer, measured waveforms can be printed to paper immediately.

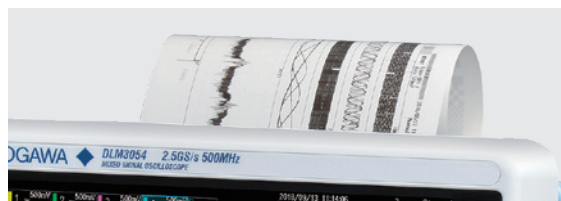

A Variety of Triggers and Analysis Functions

- A variety of triggers capture complex waveforms
- Real time digital filter with optimum noise reduction
- Zooms into two different points simultaneously
- Automated measurement of waveform parameters and statistical processing function
- Frequency analysis by FFT computation
- Go/No-Go function and action on trigger function to determine abnormal waveforms and save files
- Analysis functions for specific applications, such as serial bus analysis and power supply analysis

Easy and intuitive operation with touch screen

- Rect Zoom for easy zooming by swiping your finger diagonally across the screen to specify the area.
- To select items on the dialog box, you can directly touch them, which eliminates the trouble of using select keys.



Changing zoom ratio by pinching in and out

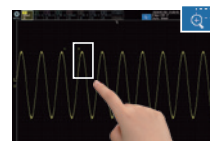

Rect Zoom



Selecting waveform parameter items

The Unique Eight Analog Channel 500 MHz Oscilloscope for Faster and More Advanced Power Electronics, Automobile Electronics, and Mechatronics Development



See brochure for details: Bulletin DLM5000-01EN



Specifications

Models

Model name	A/D resolution	Frequency bandwidth	Analog input	Logic input	Max. sample rate		
DLM5038HD	12 bit	350 MHz	8 channels	16 bit (Standard) or 32 bit (/L4 or /L32)	2.5 GS/s		
DLM5058HD		500 MHz					
DLM5034HD		350 MHz	4 channels				
DLM5054HD		500 MHz					
DLM5038	8 bit	350 MHz	8 channels			16 bit (Standard) or 32 bit (/L4 or /L32)	2.5 GS/s
DLM5058		500 MHz					
DLM5034		350 MHz	4 channels				
DLM5054		500 MHz					

Analog Signal input

Input channels	DLM50x8HD, DLM50x8: CH1 to CH8 DLM50x4HD, DLM50x4: CH1 to CH4
Input coupling setting	AC 1 M Ω , DC 1 M Ω , DC 50 Ω
Input impedance	Voltage axis sensitivity setting range: 1 M Ω 500 μ V/div to 10 V/div (steps of 1-2-5) 50 Ω 500 μ V/div to 1 V/div (steps of 1-2-5)
Vertical-axis (voltage-axis) DC accuracy*1	500 μ V/div \pm (3.0% of 8 div + offset voltage accuracy) 1 mV/div to 10 V/div \pm (1.5% of 8 div + offset voltage accuracy)
A/D conversion resolution	DLM50xxHD: 12 bit (400 LSB/div) Max., 16 bit (in High Resolution mode) DLM50xx: 8 bit (25 LSB/div) Max., 12 bit (in High Resolution mode)

Logic Signal Input

Maximum toggle frequency	100 MHz (701988) or 250 MHz (701989)
Probes that can be used	701988 and 701989 (701980 and 701981)
Minimum input voltage	500 mVp-p (701988) or 300 mVp-p (701989)
Input range	\pm 40 V (701988), Threshold level \pm 6 V (701989)
Maximum non-destructive input voltage	\pm 40 V (DC + AC peak) or 28 Vrms (701989)
Threshold level setting range	\pm 40 V (701988) or \pm 6 V (701989)

Common Specifications

Maximum sampling rate	Real-time sampling mode: 2.5 GS/s Repetitive sampling mode: 250 GS/s
Time axis setting range	1 ns/div to 500 s/div

Maximum record length (Points)	Repeat		Single
	Standard	12.5 M	50 M (125 M)
/M1 or /M1S	25 M	125 M (250 M)	
	/M2 or /M2S	50 M	250 M (500 M)
	/M3 or /M3S	125 M	500 M (1 Giga)

When selected in parentheses, only logic ports A and B are valid.
*M3 or /M3S are applicable to DLM50xxHD only

History memory maximum data	200000 (record length 1.25 kPoints; /M3 or /M3S) 20000 (record length 1.25 kPoints; standard)
Trigger modes	Auto, Auto Level, Normal, Single, N-Single, Force
Serial Bus Signal Analysis Functions Supported standards	UART (RS232) /I ² C/SPI/CAN/CAN FD/LIN/FlexRay/SENT/CXPI/PSI5 Airbag
Trigger types	Edge, Edge OR, Pulse Width, Timeout, Pattern, Runt, Rise/Fall Time, Interval, Window, Window OR, TV, Serial Bus (I ² C/SPI/UART/CAN/CAN FD/LIN/FlexRay/SENT/CXPI/PSI5 Airbag/UserDefine), A Delay B, A to B (N)
Internal storage	1.7 GB (standard) or 64 GB (/C8 option)
Synchronous Operation (DLMsync)	Connect two DLM5000 units or DLM5000HD with the dedicated cable for synchronous operation (701982-01, -02). Between DLM5000 and DLM5000HD cannot be connected
Interfaces	USB peripheral connection terminal \times 2 USB-PC connection terminal \times 1 Ethernet (standard), GP-IB (option)
Build-in printer (option)	112 mm wide, monochrome, thermal
Display	12.1-inch TFT LCD with a capacitive touch screen, 1024 \times 768 (XGA)
Dimensions	426 (W) \times 266 (H) \times 180 (D) mm
Weight	Approx. 7.3 kg (with no options)

Features

The analog 8-channel input oscilloscope is now available with high resolution on the voltage axis, inheriting the operability and functionality of previous models. The high-resolution oscilloscope enables even more detailed waveform measurements.

- 8 analog channels (DLM50x8 or DLM50x8HD) or 4 analog channels (DLM50x4 or DLM50x4HD), and 16 bits logic input for each models
- Optional 16-bit logic input
- Vertical axis resolution: 12 bit (DLM50xxHD) or 8bit (DLM50xx) at all time
- Up to 2.5 GS/s
- 350 MHz or 500 MHz frequency bandwidth
- 12.1-inch large display and intuitive touch screen operation
- Large memory of up to 1 Gpoints (for DLM50xxHD) or 500 Mpoints (for DLM50xx)
- Light, slim, and compact design
- "DLMsync" meets your demand for even more multichannel measurements.

DLM5000HD/DLM5000 Comparison

Feature	DLM5000HD	DLM5000
Vertical axis resolution	12 bit (Hi-res 16 bit)	8 bit (Hi-res 12 bit)
Memory size	Up to 1 G point	Up to 500 M point
Number of history waveforms	Up to 200000	Up to 100000
IEEE1588 synchronous support	Master function available (/CY)	Requires another master machine.

12-bit high resolution and wide bandwidth measurement

Supported models **DLM5000HD**

Momentary phenomena, such as overshoot, at the rise of a high-speed inverter cannot be verified with a low bandwidth oscilloscope. The DLM5000HD combines a wide bandwidth of up to 500 MHz with a sample rate of up to 2.5 GS/s, making it a powerful tool for measuring a wide variety of devices that have become increasingly faster in recent years. In addition, a 12-bit measuring instrument is very effective in accurately measuring events such as ringing after overshoot. Optimal range settings can be made to capture minute changes accurately while checking the whole image of the waveform.

Up to 2.5 GS/s (eight channels at once) and up to 1 G points-long memory

Supported models **DLM5000HD** **DLM5000**

The evaluation of an embedded system requires the verification of its operation over a relatively long period of time with software commands and the simultaneous viewing of waveforms of high-speed signals such as clock noise. The DLM5000HD has a memory capacity of up to 500 M points in single mode/125 M points in repeat mode for waveform capture when all channels are used. You can observe waveforms with very few omissions.

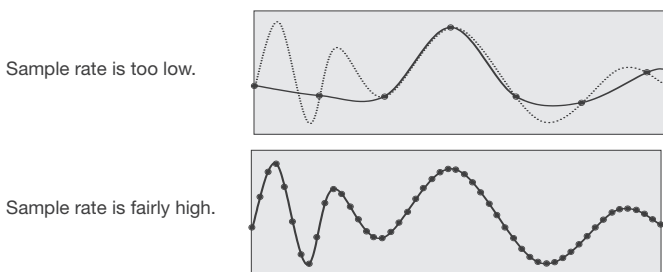

More memory is needed to use higher sample rates and capture the most accurate waveform representation.

DLMsync two-unit connection function for more channels (/SY or /SYN option)

Supported models **DLM5000HD** **DLM5000**

Connecting two DLM5000 Series models (with /SY or /SYN option) with a dedicated cable (701982) enables synchronous measurement of up to 16 channels. Captured waveforms are displayed on each unit. Triggers operate in common, and common items, such as record length, sample rate, acquisition settings and horizontal axis scale settings, are linked, so they can be used like a single 16-channel oscilloscope. You can also connect 4 ch models, making “8 + 4 = 12 channels” or “4 + 4 = 8 channels” possible.

*Between DLM5000 and DLM5000HD cannot be connected via the DLMsync function.

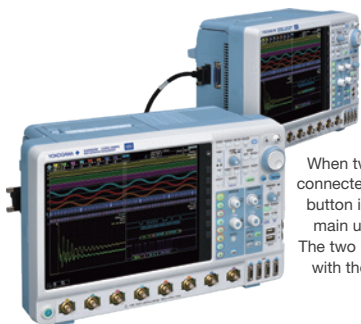

When two DLM5000HD/5000 series models are connected, the one that you press the “Connect” button in the “DLMsync” menu on becomes the main unit, and the other becomes the sub unit. The two units capture waveforms simultaneously with the sampling clock and trigger of the main unit.

Large selection of triggers

Supported models **DLM5000HD** **DLM5000**

When you capture a waveform of concern, your work efficiency will deteriorate if you are at a loss to determine whether the characteristic waveform is occurring regularly or under specific conditions.

The DLM5000HD and DLM5000’s extensive triggers can be used to trigger on the feature points of waveforms to extract waveforms of interest and store them in the history memory. You can display a list of history waveforms to see the intervals between triggers or line up several waveforms to see what trends are evident around the feature points. This helps determine how often or under what conditions a characteristic waveform occurs.

Trigger types

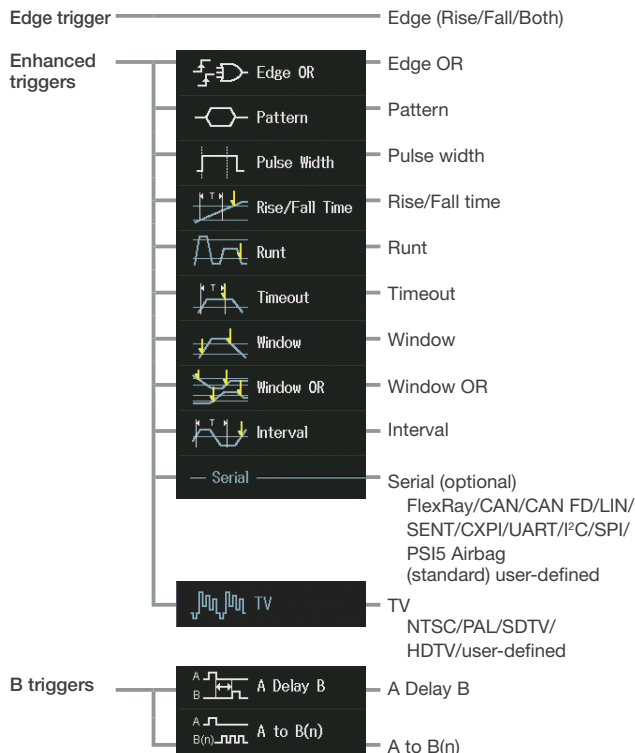

Filter functions

Supported models **DLM5000HD** **DLM5000**

Real time filter with optimum noise reduction supports a wide range of frequencies — from 8 kHz to 200 MHz — Each channel has 14 low pass filters available with cutoff frequencies from 8 kHz to 200 MHz. Waveforms are filtered prior to storage in memory. Real-time filters allow for stable triggering of superimposed noise signals.

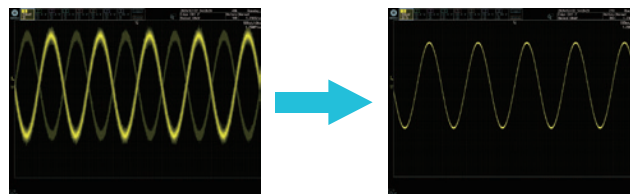

Stable trigger as a result of noise reduction

12.1 inch large screen provides a comfortable debugging environment

Supported models **DLM5000HD** **DLM5000**

Equipped with a 12.1-inch large touch screen. The large screen is useful for observing analog signals in detail and displaying information for debugging, such as parameters, zoom screen, XY display, and FFT analysis results.

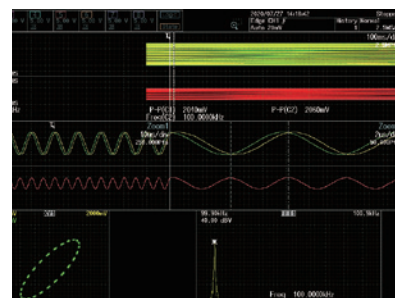

Easy to carry and measures quickly

Supported models **DLM5000HD** **DLM5000**

While the DLM5000HD is a large screen model with multichannel inputs, it comes in a portable, thin & lightweight design. The instrument starts up from OFF to waveform display in twelve seconds. You can start measurement work immediately.

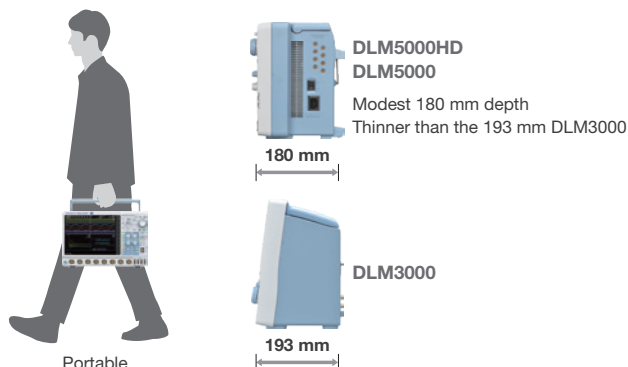

Serial analysis function options (/F1 to /F6, /F01 to /F06)

Supported models **DLM5000HD** **DLM5000**

UART (RS232) /I²C/SPI/CAN/CAN FD/LIN/FlexRay/SENT/CXPI/PSI5 Airbag

Dedicated trigger and analysis options are available for various serial buses of both in-vehicle and embedded systems. Logic input can also be used for I²C/SPI/UART/SENT. When it is not necessary to observe waveform quality of a bus, decoding or analysis using logic inputs is possible.

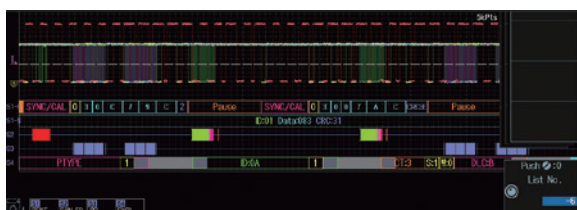

Waveform display and decode results

Useful auto setup

Yokogawa's proprietary auto setup function automatically analyzes the input signal or captured waveforms and complex parameters such as bit rate and threshold level, selecting the optimal settings in seconds. This feature not only saves time but is also a powerful debugging feature when the bit rate and other parameters are unknown.

Simultaneous analysis of up to 4 buses

Perform high-speed simultaneous analysis on up to four different serial buses operating at different speeds. Extensive search capabilities enhance the usability, allowing the user to find specific data in the very long memory. The dual-zoom facility means that different buses can be viewed and debugged alongside each other.

Serial Bus			
SI: SENT	SI: CAN FD	SI: I ² C	SI: CXPI
No.	Time (ms)	Time (ms)	Time (ms)
5	-4.5200	0	-4.5000
4	-3.8500	1	0.5000
2	-2.8510	2	1.1620
2	-2.5020	3	1.8340
-1	-1.2200	4	2.3980
6	-0.3780	5	2.9620
1	0.4740	6	3.5260
2	1.1500	7	4.0900
2	2.1780	8	4.7060
4	3.2060	9	5.3220
5	3.8020	10	5.9140
6	4.7540	11	6.5120

4-bus list display

Others

- Zoom and search function—Zoom display in two independent areas—
- Cursor measure and automatic waveform parameter measurement functions
- FFT, User defined math (option) and Power supply analysis (option)

Applications

Development of motor/inverter circuits to perform high voltage switching

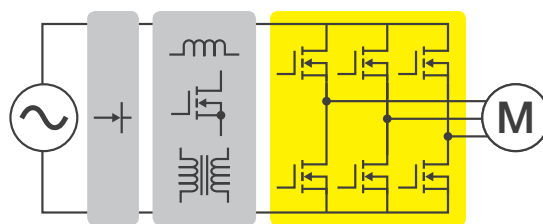

Example.

- Measuring 3 line voltages and 3 phase currents of a 3-phase motor at the same time
- Measuring gate control signals of 6 SiCs in an inverter at the same time

The DLM5000HD is a high-definition oscilloscope ideal for measuring fast switching of inverters. It can measure eight channels simultaneously at up to 2.5 GS/s with bandwidths of up to 500 MHz and provide high-precision analysis with 12-bit resolution. In addition, the DLMsync allows two DLM5000HD Series models to be connected without complicated settings, so settings to allow evaluation tests to be completed all at once by performing multi-point measurements.

The SW Loss math function is effective for inverter characterization and provides powerful analysis support. A full line of accessories for high voltages is also available that is especially useful for inverter development.

Automotive electronic control unit and mechatronics embedded device development

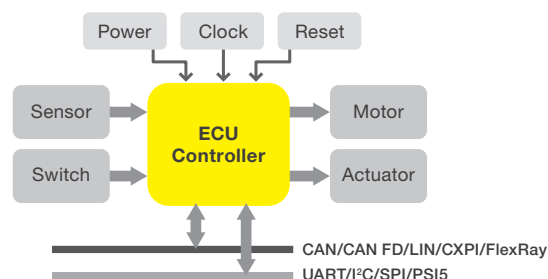

Example.

- Measuring controller I/O signals and serial bus signals at the same time
- Measuring the analog behavior of logic signals and serial bus signals

Digital waveform analysis using logic inputs alone cannot reveal anomalies such as voltage drift, noise, distortion or ringing, and measure rise-fall times. ECU testing requires stringent examination of all digital waveforms – and analog input channels are the best tool for the job.

Numerous I/O analog, digital, and serial-bus waveforms surrounding the electronic control unit (ECU) must be measured. The DLM5000HD offers ample channel-count and architecture to monitor eight analog channels and up to 32-bits of logic input while simultaneously performing protocol analysis such as UART, I²C, SPI, CAN, CAN FD, LIN, CXPI, PSI5, and FlexRay.

Model and Suffix Code

High Definition Oscilloscope DLM5000HD Series

Model ¹	Suffix Code	Description
DLM5038HD		High Definition Oscilloscope: 8 ch, 350 MHz
DLM5058HD		High Definition Oscilloscope: 8 ch, 500 MHz
DLM5034HD		High Definition Oscilloscope: 4 ch, 350 MHz
DLM5054HD		High Definition Oscilloscope: 4 ch, 500 MHz
Power cord	-D	UL/CSA Standard and PSE compliant
	-F	VDE/Korean Standard
	-Q	British Standard
	-R	Australian Standard
	-H	Chinese Standard
	-N	Brazilian Standard
	-T	Taiwanese Standard
Language	-B	Indian Standard
	-U	IEC Plug Type B
	-HJ	Japanese message and panel
	-HE	English message and panel
	-HC	Chinese message and panel
	-HG	German message and panel
	-HF	French message and panel
Option	-HK	Korean message and panel
	-HL	Italian message and panel
	-HS	Spanish message and panel
	/L4	Expansion logic 16 bit (Total 32 bit)
	/B5	Built-in printer (112 mm)
	/M1 ²	Memory expansion option (8 ch model only) During continuous measurement: 25 M points; Single mode: 125 M points/250 M points ³
	/M2 ²	Memory expansion option (8 ch model only) During continuous measurement: 50 M points; Single mode: 250 M points/500 M points ³
	/M3 ²	Memory expansion option (8 ch model only) During continuous measurement: 125 M points; Single mode: 500 M points/1 G points ³
	/M1S ²	Memory expansion option (4 ch model only) During continuous measurement: 25 M points; Single mode: 125 M points/250 M points ³
	/M2S ²	Memory expansion option (4 ch model only) During continuous measurement: 50 M points; Single mode: 250 M points/500 M points ³
	/M3S ²	Memory expansion option (4 ch model only) During continuous measurement: 125 M points; Single mode: 500 M points/1 G points ³
	/P8 ⁴	8 probe power terminals (for 8 ch model)
	/P4 ⁴	4 probe power terminals (for 4 ch model)
	/C1	GP-IB interface
	/C8	Internal storage (64 GB)
	/CY	IEEE1588 master function
	/SY ⁵	Synchronous Operation
/G2 ⁶	User-defined math function	
/G3 ⁶	Power supply analysis function	
/GA ⁶	User-defined math function + Power supply analysis function	
/F1	UART + I ² C + SPI trigger and analysis	
/F2	CAN + CAN FD + LIN trigger and analysis	
/F3	FlexRay trigger and analysis	
/F4	SENT trigger and analysis	
/F5	CXPI trigger and analysis	
/F6	PSI5 trigger and analysis	
/E1 ⁷	Four additional 701937 probes (8 in total) (for 8 ch model)	
/E2 ⁷	Attach four 701949 probes	
/E3 ⁷	Attach eight 701949 probes (for 8 ch model)	

Standard Main Unit Accessories

Power cord, Passive probe⁸, Protective front cover, Panel sheet⁹, Soft carrying case for probes, Printer roll paper (for /B5 option), Manuals¹⁰

Additional Option License for DLM5000HD

Model	Suffix Code	Description
709823	-CY	IEEE1588 master function
	-SY	Synchronous operation
	-G2	User-defined math function
	-G3	Power supply analysis function
	-F1	UART + I ² C + SPI trigger and analysis
	-F2	CAN + CAN FD + LIN trigger and analysis
	-F3	FlexRay trigger and analysis
	-F4	SENT trigger and analysis
	-F5	CXPI trigger and analysis
	-F6	PSI5 trigger and analysis

Mixed Signal Oscilloscope DLM5000 series

Model ¹	Suffix Code	Description
DLM5038		Mixed Signal Oscilloscope: 8 ch, 350 MHz
DLM5058		Mixed Signal Oscilloscope: 8 ch, 500 MHz
DLM5034		Mixed Signal Oscilloscope: 4 ch, 350 MHz
DLM5054		Mixed Signal Oscilloscope: 4 ch, 500 MHz
Power cord	-D	UL/CSA Standard and PSE compliant
	-F	VDE/Korean Standard
	-Q	British Standard
	-R	Australian Standard
	-H	Chinese Standard
	-N	Brazilian Standard
	-T	Taiwanese Standard
Language	-B	Indian Standard
	-U	IEC Plug Type B
	-HJ	Japanese message and panel
	-HE	English message and panel
	-HC	Chinese message and panel
	-HG	German message and panel
	-HF	French message and panel
Option	-HK	Korean message and panel
	-HL	Italian message and panel
	-HS	Spanish message and panel
	/L32	Expansion logic 16 bit (Total 32 bit)
	/B5	Built-in printer (112 mm)
	/M1 ²	Memory expansion option (8 ch model only) During continuous measurement: 25 M points; Single mode: 125 M points/250 M points ³
	/M2 ²	Memory expansion option (8 ch model only) During continuous measurement: 50 M points; Single mode: 250 M points/500 M points ³
	/M1S ²	Memory expansion option (4 ch model only) During continuous measurement: 25 M points; Single mode: 125 M points/250 M points ³
	/M2S ²	Memory expansion option (4 ch model only) During continuous measurement: 50 M points; Single mode: 250 M points/500 M points ³
	/P8 ⁴	8 probe power terminals (for 8 ch model)
	/P4 ⁴	4 probe power terminals (for 4 ch model)
	/C1	GP-IB interface
	/C8	Internal storage (64 GB)
	/SYN ⁵	Synchronous Operation
	/G02	User-defined math function
	/G03	Power supply analysis function
	/F01	UART + I ² C + SPI trigger and analysis
/F02	CAN + CAN FD + LIN trigger and analysis	
/F03	FlexRay trigger and analysis	
/F04	SENT trigger and analysis	
/F05	CXPI trigger and analysis	
/F06	PSI5 trigger and analysis	
/E1 ⁷	Four additional 701937 probes (8 in total) (for 8 ch model)	
/E2 ⁷	Attach four 701949 probes	
/E3 ⁷	Attach eight 701949 probes (for 8 ch model)	

Standard Main Unit Accessories

Power cord, Passive probe⁸, Protective front cover, Panel sheet⁹, Soft carrying case for probes, Printer roll paper (for /B5 option), User's manuals¹¹

Additional Option License for DLM5000

Model	Suffix Code	Description
709821	-G02	User defined math
	-G03	Power supply analysis function
	-F01	UART + I ² C + SPI trigger and analysis
	-F02	CAN + CAN FD + LIN trigger and analysis
	-F03	FlexRay trigger and analysis
	-F04	SENT trigger and analysis
	-F05	CXPI trigger and analysis
	-F06	PSI5 trigger and analysis
	-SYN	Synchronous Operation

*1: Standard memory capacity: During continuous measurement: 12.5 M points; Single mode: 50 M points/125 M points (when odd channels only)
Logic probes sold separately.

*2,*4,*6,*7: When selecting from these options, please select only one.

*3: When odd channels only

*4: Specify this option when using current probes or other differential probes that don't support probe interface.

*5: This option for both main and sub unit and a 701982 connection cable are required for synchronous operation.

*8: Four 701937 except /E2 or /E3.

*9: Except suffix code "-HE".

*10: Start guide as the printed material, and User's manual can be downloaded from our web page.

*11: Start guide as the printed material, and User's manual as CD-ROM are included.

Easy-to-Use, Portrait Body, Compact, and Large Touch Screen Personal Mixed Signal Oscilloscope



See brochure for details: Bulletin DLM3000-01EN

Specifications

Analog Signal input

Input channels	Analog input	DLM30x4: CH1 to CH4 (CH1 to CH3 when using logic input) DLM30x2: CH1, CH2	
Input coupling setting	AC 1 M Ω , DC 1 M Ω , DC 50 Ω		
Input impedance	Analog input	1 M Ω \pm 1.0%, approximately 16 pF	
		50 Ω \pm 1.0% (VSWR 1.4 or less, DC to 500 MHz)	
Voltage axis sensitivity setting range	1 M Ω 500 μ V/div to 10 V/div (steps of 1-2-5)		
	50 Ω 500 μ V/div to 1 V/div (steps of 1-2-5)		
Max. input voltage	1 M Ω Must not exceed 300 Vrms or 400 Vpeak		
	50 Ω Must not exceed 5 Vrms or 10 Vpeak		
Max. DC offset setting range	1 M Ω	500 μ V/div to 50 mV/div	\pm 1 V
		100 mV/div to 500 mV/div	\pm 10 V
	50 Ω	1 V/div to 10 V/div	\pm 100 V
		500 μ V/div to 50 mV/div	\pm 1 V
		100 mV/div to 1 mV/div	\pm 5 V

Frequency characteristics (-3 dB attenuation when inputting a sine wave of amplitude ± 3 div)^{1, 2}

		DLM302x	DLM303x	DLM305x
1 M Ω (when using attached 10:1 passive probe)	20 mV to 100 V/div	200 MHz	350 MHz	500 MHz
	10 mV/div	200 MHz	350 MHz	350 MHz
	5 mV/div	200 MHz	200 MHz	200 MHz
50 Ω	2 mV to 10 V/div	200 MHz	350 MHz	500 MHz
	1 mV/div	200 MHz	350 MHz	350 MHz
	500 μ V/div	200 MHz	200 MHz	200 MHz

Maximum sample rate	Real time sampling mode:	2.5 GS/s
	Repetitive sampling mode:	250 GS/s

Maximum record length (Points)	2 ch model		Repeat	Single (when odd ch only)
	4 ch model	Standard	12.5 M	50 M (125 M)
Option		/M1 25 M	125 M (250 M)	
/M2		50 M	250 M (500 M)	

Logic Signal Input (4 ch model only)

Number of inputs	8 bit (excl. 4 ch input and logic input)
Maximum toggle frequency ¹	Model 701988: 100 MHz, Model 701989: 250 MHz
Compatible probes	701988, 701989 (8 bit input)

Display

Display ³	8.4-inch TFT color liquid crystal display, 1024 \times 768 (XGA)
----------------------	--

General Specifications

Rated supply voltage	100 to 120 VAC/220 to 240 VAC (Automatic switching)
Rated supply frequency	50 Hz/60 Hz
Maximum power consumption	180 VA
External dimensions	226 (W) \times 293 (H) \times 193 (D) mm (when printer cover is closed, excluding protrusions)
Weight	Approx. 4.5 kg, With no options
Operating temperature range	5°C to 40°C

¹ Measured under standard operating conditions after a 30-minute warm-up followed by calibration.

² Value in the case of repetitive phenomenon.

³ The LCD may include a few defective pixels (within 3 ppm over the total number of pixels including RGB).

Features

Easy-to-Use & Easy-to-See

Easy to use. Portrait body + large touch screen

We elevated the large (8.4-inch) LCD screen up into the line of sight. Also, the portrait format saves space on the desk or test bench. A compact personal oscilloscope designed for easy viewing and ease of use.

- 1 8.4-inch XGA LCD & Capacitive touch screen
- 2 Vertical Position and Scale Knob
- 3 Horizontal Position and Scale Knob
- 4 Trigger Control Keys and Level Knob
- 5 Dedicated Zoom Keys
- 6 Logic input connector
- 7 USB peripheral connection terminal
- 8 Jog Shuttle and Rotary Knob
- 9 Four-Direction Selector Button Select key moves the cursor up/down/left/right



Large screen in a compact body

Footprint is approximately 2/3 the size of an A4 size paper (depth of approximately 200 mm)

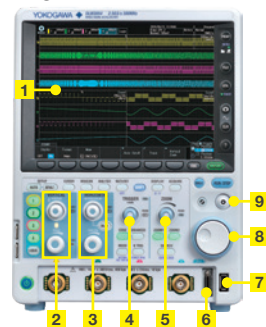

Signal observation on 4 channels or more...

Flexible MSO Input

Four channels is not sufficient to view the functioning of digital control circuits. The DLM3000 series converts 4 channels of analog input to 8-bit logic, and functions as a 3 channel analog + 8-bit logic MSO (mixed signal oscilloscope).

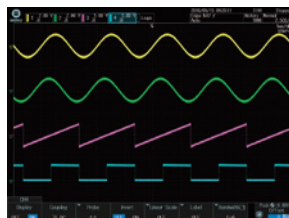

4 ch analog

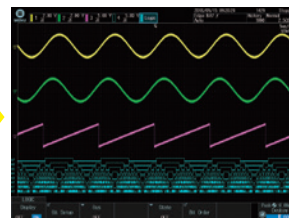

3 ch analog + 8-bit logic

You can replay waveforms later on, so you'll never miss an abnormal waveform

History function

With the DLM3000 series, up to 100000 previously captured waveforms can be saved in the acquisition memory. With the History function, you can display just one or all of the previously captured waveforms (history waveforms) on screen. You can also perform cursor measurement, computation, and other operations on history waveforms. Using the History function, you can analyze rarely-occurring abnormal signals.

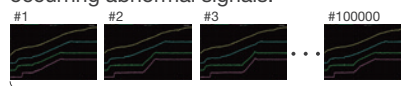

View individual captures to identify the relationship between channels at a specified moment in time.

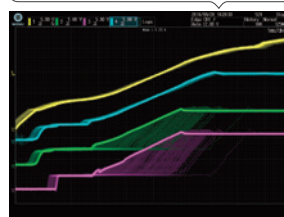

All waveform display mode

Extract abnormal waveform

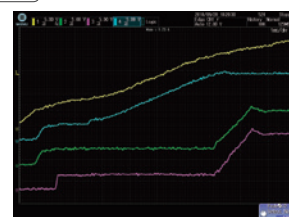

One waveform display mode

Even complex waveforms can be captured

Variety of triggers combining analog and logic inputs

The DLM3000 series comes with a variety of triggers ranging from an easy and simple Edge trigger through to sophisticated Enhanced and B triggers. In particular, its ability to freely combine analog and logic inputs is a great feature of this mixed signal oscilloscope.

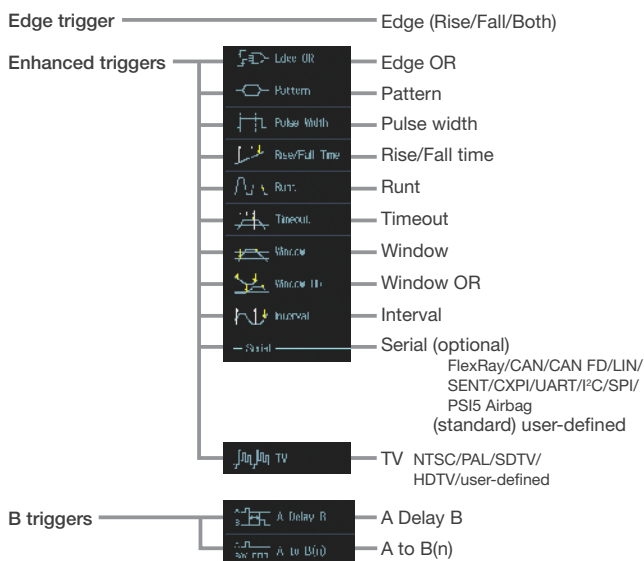

Optimum noise reduction

Real time filters and filters based on MATH functions

The DLM3000 series has two types of filters, one real time processed at the input circuit and one based on MATH functions. Since the cutoff frequency can also be finely set, these filters are effective in rejecting unwanted signals and observing only the desired signals.

Waveform zoom and search functions

Zoom two locations simultaneously, zoom search and history search

Because the DLM3000 series lets you set zoom factors independently, you can display two zoomed waveforms with different time axis scales at the same time. Also, using the search functions, you can search the long memory and History waveforms and instantaneously find desired waveforms that meet the search criteria.

Can check functions with graphical help

Graphical online help

You can view detailed graphical explanations of the oscilloscope's functions and operations by pressing the "?" key in the lower right of the screen. This lets you get help on functions and operations on screen without having to consult the user's manual.

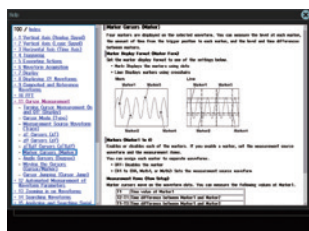

Analysis Functions

FlexRay/UART/CAN/CAN FD/LIN/CXPI/SENT/I²C/SPI/PSI5 Airbag

Serial analysis function options

A wide variety of trigger conditions can be set, such as ID/Data trigger combinations and combinations of serial bus triggers with normal edge triggers. Up to four busses with different types and speeds can be analyzed simultaneously and decode display can be shown in real time.

Switching loss, power measurement, joule integral, SOA analysis, and harmonic current based on EN61000-3-2

Power supply analysis option

Utilizing the long memory capability, voltage and current waveforms over long cycles can be input for computation of switching loss $[V(t) \times i(t)]$. A wide variety of switching loss analyses are supported, including turn on/off loss calculation, loss including conduction loss, and loss over long cycles (50 Hz/60 Hz). Automated measurement of power parameters for up to two pairs of voltage and current waveforms, such as active power, apparent power, power factor and so on.

Model and Suffix Code

Model ¹	Suffix Code	Description	
DLM3022		Digital Oscilloscope: 2 ch, 200 MHz	
DLM3024 ²		Mixed Signal Oscilloscope: 4 ch, 200 MHz	
DLM3032		Digital Oscilloscope: 2 ch, 350 MHz	
DLM3034 ²		Mixed Signal Oscilloscope: 4 ch, 350 MHz	
DLM3052		Digital Oscilloscope: 2 ch, 500 MHz	
DLM3054 ²		Mixed Signal Oscilloscope: 4 ch, 500 MHz	
Power cord	-D	UL/CSA Standard and PSE compliant	
	-F	VDE/Korean Standard	
	-Q	British Standard	
	-R	Australian Standard	
	-H	Chinese Standard	
	-N	Brazilian Standard	
	-T	Taiwanese Standard	
	-B	Indian Standard	
	-U	IEC Plug Type B	
	Language	-HJ	Japanese message and panel
-HE		English message and panel	
-HC		Chinese message and panel	
-HG		German message and panel	
-HF		French message and panel	
-HK		Korean message and panel	
-HL		Italian message and panel	
-HS		Spanish message and panel	
Option		/LN	No switchable logic input (4 ch model only)
		/B5	Built-in printer (112 mm)
	/M1 ³	Memory expansion option (4 ch model only) During continuous measurement: 25 Mpoints; Single mode: 125 Mpoints/250 Mpoints ⁴	
	/M2 ³	Memory expansion option (4 ch model only) During continuous measurement: 50 Mpoints; Single mode: 250 Mpoints/500 Mpoints ⁴	
	/P2 ⁵	2 probe power terminals (for 2 ch model)	
	/P4 ⁵	4 probe power terminals (for 4 ch model)	
	/C1	GP-IB interface + GO/NO-GO terminal	
	/C8	Internal storage (60 GB)	
	/G02	User-defined math function (4 ch model only)	
	/G03	Power supply analysis function (4 ch model only)	
/F01	UART + I ² C + SPI trigger and analysis (4 ch model only)		
/F02	CAN + CAN FD + LIN trigger and analysis (4 ch model only)		
/F03	FlexRay trigger and analysis (4 ch model only)		
/F04	SENT trigger and analysis (4 ch model only)		
/F05	CXPI trigger and analysis (4 ch model only)		
/F06	PSI5 trigger and analysis (4 ch model only)		
/EX2 ⁶	Replace all probes with 701949 (2 ch model only)		
/EX4 ⁶	Replace all probes with 701949 (4 ch model only)		

Standard Main Unit Accessories

Power cord, Passive probe⁷, Protective front cover, Panel sheet⁸, Soft carrying case for probes, Printer roll paper (for /B5 option), User's manuals⁹































¹: Standard memory capacity: During continuous measurement: 12.5 Mpoints; Single mode: 50 Mpoints/125 Mpoints (when odd channels only) ²: Logic probes sold separately. Please order the model 701988/701989 accessory logic probes separately. ³, ⁶: When select from these options, please select only one. ⁴: When odd channels only ⁵: Specify this option when using current probes or other differential probes that don't support probe interface. ⁷: 701937, per number of channels. When either /EX2 or /EX4 option is selected, no 701937 is included. ⁸: Except suffix code "-HE". ⁹: Start guide as the printed material, and User's manual as CD-ROM are included.

Additional Option License for DLM3000¹

Model	Suffix Code	Description
709811	-G02	User defined math
	-G03	Power supply analysis function
	-F01	UART + I ² C + SPI trigger and analysis
	-F02	CAN + CAN FD + LIN trigger and analysis
	-F03	FlexRay trigger and analysis
	-F04	SENT trigger and analysis
	-F05	CXPI trigger and analysis
	-F06	PSI5 trigger and analysis

¹: Separately sold license product (customer-installable). (4 ch model only)

Waveform Measuring Oscilloscopes Accessories

Classification	Product	Model No.	Power supply		Description	Models		Appearance
			Probe interface terminal (front panel) ^{*1}	Probe power (option)/ probe power supply (sold separately)		DLM5000HD DLM5000 DLM3000	DLM4000 DLM2000	
Passive	500 MHz passive probe	701937			DC to 500 MHz, 10:1, 1.3 meters	Yes	No	
	Miniature passive probe	701949			DC to 500 MHz, 10:1, 1.3 meters	Yes	No	
	10:1 Passive probe	702907			DC to 200 MHz, 10:1, 2.5 meters, -40°C to +85°C (Operating temperature range)	Yes	No	
	500 MHz passive probe	701939			DC to 500 MHz, 10:1, 1.3 meters	No	Yes	
	500 MHz Miniature passive probe	701946			DC to 500 MHz, 10:1, 1.2 meters	No	Yes	
	200 MHz passive probe (wide temperature range)	702906			DC to 200 MHz, 10:1, 2.5 meters, -40°C to +85°C (Operating temperature range)	No	Yes	
Passive (High-voltage)	100:1 High voltage probe	701944			DC to 400 MHz, 100:1, 1.2 meters			
	100:1 High voltage probe	701945			DC to 250 MHz, 100:1, 3.0 meters			
FET	900 MHz FET Probe	700939		Yes	DC to 900 MHz, 1.5 meters			
Low Capacitance	5 GHz low capacitance probe (PBL5000)	701974			DC to 500 MHz, 10:1/20:1, 1.1 meters			
Differential	1 GHz differential probe (PBDH 1000)	701924	Yes		DC to 1 GHz, 50:1, Max. differential input voltage: ±25 V			
	500 MHz differential probe (PBDH 0500)	701925	Yes		DC to 500 MHz, 50:1, Max. differential input voltage: ±25 V (DC + ACpeak)			
	150 MHz differential probe (PBDH 0150)	701927	Yes		DC to 150 MHz, 50:1, 500:1, Max. differential input voltage: ±140 V (50:1), ±1400 V (500:1)			
	50 MHz high voltage differential probe	701977		Yes	DC to 50 MHz, 100:1, 1000:1, Max. differential input voltage: 5000 Vrms or less, and 7000 Vpeak or less			
	150 MHz differential probe	701978		Yes	DC to 150 MHz, 50:1, 500:1, Max. differential input voltage: ±1500 V (DC + ACpeak)			
Current	Current probe	702916		Yes	DC to 120 MHz, 0.5 Arms, 5 Arms, 30 Arms, 3 ranges			
	Current probe	702915		Yes	DC to 50 MHz, 0.5 Arms, 5 Arms, 30 Arms, 3 ranges			
	Current probe	701918		Yes	DC to 120 MHz, 5 Arms, High-sensitivity			
	Current probe	701917		Yes	DC to 50 MHz, 5 Arms, High-sensitivity			
	Current probe (PBC100)	701928	Yes		DC to 100 MHz, 30 Arms			
	Current probe (PBC050)	701929	Yes		DC to 50 MHz, 30 Arms			
	Current probe	701932		Yes	DC to 100 MHz, 30 Arms			
	Current probe	701933		Yes	DC to 50 MHz, 30 Arms			
	Current probe	701930		Yes	DC to 10 MHz, 150 Arms			
	Current probe	701931		Yes	DC to 2 MHz, 500 Arms			
Logic	100 MHz Logic probe (PBL100)	701988			Input impedance 1 MΩ, Max. toggle frequency: 100 MHz			
	250 MHz Logic probe (PBL250)	701989			Input impedance: 100 kΩ, Max. toggle frequency: 250 MHz			
Other	De-skew correction signal source	701936			Voltage/current signal de-skew Supports through-type current transformers and a variety of current probes, including large current probes.			
	Probe power supply	701934			Large current output, external probe power supply (4 outputs)			
	Probe stand	701919			Diameter of attachable probe 8 mm diameter to 13 mm Weight: Approx. 1.5 kg			
	Connection cable	701982-01			For synchronous operation of DLM5000/5000HD (DLMsync) 1 m			
701982-02				For synchronous operation of DLM5000/5000HD (DLMsync) 2.8 m				

These specifications are a summary. For details, please refer to the Web site, catalog, and other documentation. *1: Available as standard for the DLM5000HD, DLM5000, DLM4000, DLM3000, DLM2000, DLM6000 and DL6000 series.

In addition to those listed above, there are other accessories available. For details, please refer to the Web site. When using multiple current probes using the probe power of the main unit, ensure that the total power supply current of the current probes does not exceed the maximum output current of the probe power.

Instrument Control & Data Analysis on Your PC

Xviewer is a PC software application designed to work with Yokogawa's DLM/DL/SL series. Xviewer allows you to display acquired waveform data (using the "Viewer" function), perform file transfers, and control DLM/DL/SL series from a PC. DL950 and DLM5000HD are only supported on "IS8000 Integrated Software Platform".

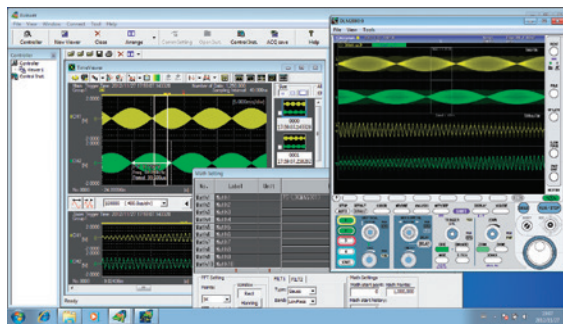

Oscilloscope Application Software XviewerLITE (Free software)

Free Data Viewer

XviewerLITE is a free data viewer software for DLM/DL/SL series. It allows you to display acquired waveform on a PC. Zoom, vertical cursor measurement and CSV format conversion are possible. DL950 and DLM5000HD are only supported on "IS8000 Integrated Software Platform".

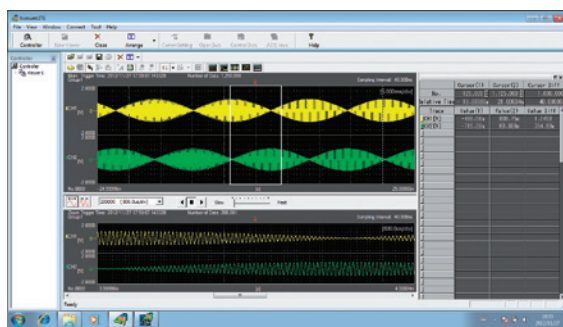

Oscilloscope Application Software XWirepuller/Wirepuller (Free software)

Remote Control Measuring Instrument on Your PC

With this software, you can display the front panel of the DLM/DL/SL series on the screen of a PC, and monitor waveform signals. You can perform control from the PC using the mouse and keyboard in the same way as you operate the main unit. DL950 and DLM5000HD are only supported on "IS8000 Integrated Software Platform".



In addition to the above, various kinds of accessory software, free software, LabVIEW drivers, and LabWindows/CVI drivers, can be downloaded from our web site.

Power Analyzers and Power Meters Selection Guide*1

Yokogawa's PX8000 and WT Series Power Meters and Power Analyzers:
Advanced Technology and High Reliability for a Wide Range of Power Measurement Solutions



Product Type/ Item	Digital Power Meter WT300E series	Power Analyzer WT500	Precision Power Analyzer WT5000	Precision Power Analyzer WT1800E	Precision Power Scope PX8000
Features	<ul style="list-style-type: none"> Entry Class Digital Power Meters 4 models line up, equipping 5 mA range (WT310E), 40 A range (WT310EH), and 2 or 3 CH inputs (WT332E/WT333E) Standard Communication I/F and auto-ranging under integration mode 	<ul style="list-style-type: none"> Low-Middle Class Power Analyzer Compact half rack size and easy use Max. 1000 V and 40 A input Simultaneous measurement U, I, P and those harmonics components External USB memory for direct data saving 	<ul style="list-style-type: none"> The world highest class accuracy Digital Power Analyzer with basic power accuracy of $\pm 0.03\%$ of total and DC & 0.1 Hz to 10 MHz voltage measurement bandwidth Up to 7 power input measurement with modular structure Data streaming, IEC harmonic/flicker test 	<ul style="list-style-type: none"> Middle Class Digital Power Analyzer Up to six Input elements in one instrument (3 phase power input from two systems in one unit) 8.4-Inch XGA TFT Color LCD Wide voltage and current input range Power supply for AC/DC current sensors (optional) 	<ul style="list-style-type: none"> A power analyzer with capabilities of transient power measurement and waveform parameter measurement Fast sampling up to 100 MS/s, Broad bandwidth up to 20 MHz (-3 dB), Trend measurement of each cycle, Specified period measurement by cursors Power supply for AC/DC current sensors (optional)
Input elements	1 (WT310E, WT310EH), 2 (WT332E), 3 (WT333E)	1 to 3	Modular structure 1 to 7 power measurement element	1 to 6	Module structure, 1 to 4 power measurement element
Basic power accuracy (50/60 Hz)	$\pm (0.1\% \text{ of reading} + 0.05\% \text{ of range})$	$\pm (0.1\% \text{ of reading} + 0.1\% \text{ of range})$	$\pm (0.01\% \text{ of reading} + 0.02\% \text{ of range})$	$\pm (0.05\% \text{ of reading} + 0.05\% \text{ of range})$	$\pm (0.1\% \text{ of reading} + 0.1\% \text{ of range})$
Power measurement frequency range	DC, 0.1 Hz to 100 kHz (WT310EH is up to 20 kHz)	DC, 0.5 Hz to 100 kHz	DC, 0.1 Hz to 1 MHz	DC, 0.1 Hz to 1 MHz	DC, 0.1 Hz to 1 MHz
Input voltage range (for crest factor 3)	15/30/60/150/300/600 V	15/30/60/100/150/300/600/1000 V	1.5/3/6/10/15/30/60/100/150/300/600/1000 V	1.5/3/6/10/15/30/60/100/150/300/600/1000 V	1.5/3/6/10/15/30/60/100/150/300/600/1000 V
Input current range (for crest factor 3)	Direct input: <ul style="list-style-type: none"> WT310E 5 m/10 m/20 m/50 m/100 m/200 m/500 m/1/2/5/10/20 A WT310EH 1/2/5/10/20/40 A WT332E, WT333E 500 m/1/2/5/10/20 A External input (option): 2.5/5/10 V, or 50 m/100 m/200 m/500 m/1/2 V	Direct input: 500 m/1/2/5/10/20/40 A External sensor input (option): 50 m/100 m/200 m/500 m/1/2/5/10 V	Direct input: 0.5/1/2/5/10/20/30 A (760901) or 5 m/10 m/20 m/50 m/100 m/200 m/500 m/1/2/5 A (760902) External sensor input: 50 m/100 m/200 m/500 m/1/2/5/10 V AC/DC CT series and current clamp probes are available. (760903) See Bulletin WT5000-01EN for more detail. 760901, 760902 and 760903 can be installed together in one main unit.	Direct input: 10 m/20 m/50 m/100 m/200 m/500 m/1/2/5 A or 1/2/5/10/20/50 A External input (option): 50 m/100 m/250 m/500 m/1/2/5/10 V 5 A and 50 A can be mixed in one unit	Direct input: 10 m/20 m/50 m/100 m/200 m/500 m/1/2/5 A External sensor input: 50 m/100 m/250 m/500 m/1/2/5/10 V
Measurement parameters	Voltage, Current, Active power, Reactive power, Apparent power, Power factor, Phase angle, Peak voltage, Peak current, Frequency, Crest factor, Integration (power and current), Harmonic distortion, Harmonic components	Voltage, Current, Active power, Reactive power, Apparent power, Power factor, Phase angle, Peak voltage, Peak current, Voltage frequency, Current frequency, Active power integration and Current integration for both charge/discharge and sold/bought, crest factor, Efficiency, Harmonic analysis	Voltage, Current, Active power, Apparent power, Reactive power, Power factor, Phase angle, Peak voltage, Peak current, Voltage frequency, Current frequency, Active power integration, Current integration, Crest factor, Form factor, Impedance, Resistance, Reactance, Corrected Power, Harmonic analysis IEC regulation test	Voltage, Current, Active power, Apparent power, Reactive power, Power factor, Phase angle, Peak voltage, Peak current, Voltage frequency, Current frequency, Active power integration, Current integration, Crest factor, Form factor, Impedance, Resistance, Reactance, Corrected Power, Harmonic analysis	Voltage, Current, Active power, Reactive power, Apparent power, Power factor, Phase angle, Peak voltage, Peak current, Voltage frequency, Current frequency Transient voltage/current/power (Trend of waveform by cycle), Averaged voltage/current/power by cursor (waveform parameters calculation)
Display	7 Segment LED, 4 displays	5.7-inch TFT color LCD	10.1-inch TFT color LCD (WXGA) with touch screen	8.4-inch XGA TFT color LCD	10.4 inch TFT color LCD (XGA)
External dimensions (W × H × D)	213 × 88 × 379 mm (WT310E and WT310EH) 213 × 132 × 379 mm (WT332E and WT333E)	213 × 177 × 408.5 mm	426 × 177 × 469 mm	426 × 177 × 459 mm 426 × 221 × 459 mm (with/PD2)	355 × 259 × 180 mm 355 × 259 × 245 mm (with/PD2)
Weight	3 kg (WT310E), 5 kg (WT330E)	6.5 kg	12.5 kg (without input element)	15 kg	6.5 kg (without any options and paper)

*About CW series Clamp-on Power Meters, please refer to the page 117.

Compact and Easy to Use The Power Analyzer for the Renewable Energy Generation



See brochure for details: Bulletin 7602-00E

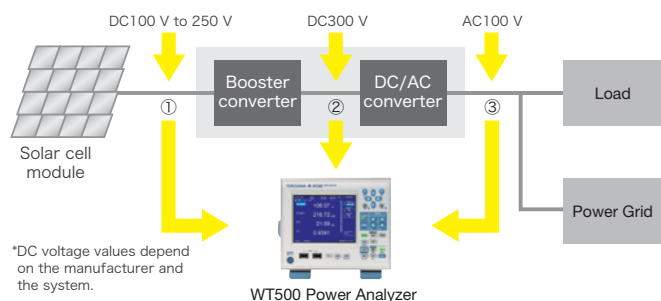

Overview of a Photovoltaic Inverter Evaluation

Specifications

Measurement voltage range (for crest factor 3)	15/30/60/100/150/300/600/1000 V
Measurement current range (for crest factor 3)	
Direct input	500 m/1/2/5/10/20/40 A
External sensor input (option)	50 m/100 m/200 m/500 m/1/2/5/10 V
Frequency range	DC, 0.5 Hz to 100 kHz
Measurement Accuracy	
Basic Accuracy	45 Hz ≤ f ≤ 66 Hz and DC
Voltage/Current/Power	±(0.1% of reading + 0.1% of range)
USB interface to PC is standard feature	±(0.1% of reading + 0.1% of range)
Communication Interface (option)	Ethernet, GP-IB
Effective of power factor (at cos φ = 0)	±0.2% of S (apparent power)
External dimensions	Approx. 213 (W) × 177 (H) × 408.5 (D) mm
Weight	Approx. 6.5 kg (with 3-input element)

Overview

The WT500 is a low-middle class power analyzer and it features a 5.7-inch color TFT and half width racking compact body that enables single-phase and three-phase power measurement, achieving ±0.2% of total basic and DC accuracy, maximum input of 1000 Vrms, 40 Arms and a measurement bandwidth up to 100 kHz.

Features

- Accurate efficiency measurement of DC and AC signals
- RMS, MEAN, DC, AC and RMEAN of voltages and currents simultaneous measurement
- Simultaneous measurement of normal U/I/P data and those harmonic data
- As fast as 100 ms data capturing and store data with all channels
- Separate integration functions for charge/discharge or bought/sold power
- Integration of power, reactive power, apparent power, and current enables you to determine a device's average power consumption
- Harmonics (DC-50th order) and Total harmonic distortion (THD) can be measured
- Saving measured data directly to external USB memory
- Measurement values can be saved as images or numerical data, and can be pasted into reports, analyzed in spreadsheet software, or used in a variety of other ways
- Easy setup with arrow keys
- GP-IB, USB and Ethernet communication are available

Model and Suffix Code

Model	Suffix Code	Description
760201		WT500 1 input element model
760202		WT500 2 input elements model
760203		WT500 3 input elements model
Power cord	-B	Indian Standard
	-D	UL/CSA Standard, PSE Compliant
	-F	VDE/Korean Standard
	-H	Chinese Standard
	-N	Brazilian Standard
	-Q	BS Standard
	-R	Australian Standard
	-T	Taiwanese Standard
	-U	IEC Plug Type B
Options	/C1	GP-IB interface
	/C7	Ethernet interface
	/EX1	External sensor input for 760201
	/EX2	External sensor input for 760202
	/EX3	External sensor input for 760203
	/G5	Harmonic Measurement
	/DT	Delta computation (760202/03 only)
	/FQ	Add-on Frequency Measurement (760202/03 only)
	/V1	VGA Output

Basic Power Accuracy of $\pm 0.03\%$ & 7 Input Elements Achieve Higher Accuracy Power Measurement



See brochure for details: Bulletin WT5000-01EN

Towards the realization of a sustainable society, renewable energy such as solar/wind power generation is promoted globally and the development of EVs, PHVs, and their infrastructure systems is accelerating. WT5000 is a high precision power analyzer with drastically improved performance and functions to support further electric power saving and higher efficiency design of those devices and equipment.

Specifications

Voltage ranges	1.5/3/6/10/15/30/60/100/150/300/600/1000 V
Current ranges	
Direct input	0.5/1/2/5/10/20/30 A (760901) 5 m/10 m/20 m/50 m/100 m/200 m/500 m/1/2/5 A (760902)
External current sensor input	50 m/100 m/200 m/500 m/1/2/5/10 V (760901/760902)
Sensor input	Input resistance: 1 Ω 10 mA/25 mA/50 mA/100 mA/250 mA/500 mA/1 A (760903) See Bulletin WT5000-01EN for the others.
Probe input	50 mV/100 mV/200 mV/500 mV/1 V/2 V/5 V/10 V (760903)
Measurement bandwidth (Power)	DC, 0.1 Hz to 1 MHz
Basic power accuracy (45 Hz to 66 Hz)	$\pm(0.01\%$ of reading + 0.02% of range)
DC power accuracy	$\pm(0.02\%$ of reading + 0.05% of range)
Date update rate	10 m/50 m/100 m/200 m/500 m/1/2/5/10/20 s
Effect of Power factor	$\pm 0.02\%$ of S (S: Apparent power at $\cos \phi = 0$)
A/D converter	Sample rate: Up to 10 MS/s, Resolution: 18 bits
Display	10.1 inch Color TFT (WXGA) Touch screen
Communication I/F (Standard function)	GP-IB, Ethernet (1000Base-T, VXI-11) and USB (3.0 USB-TMC)
External dimensions	Approx. 426 (W) \times 177 (H) \times 469 (D) mm
Weight	Approx. 12.5 kg (Main frame without input element)



Complies with 21 CFR 1040.10 and 1040.11 except for deviations pursuant to Laser Notice No.50, dated June 24, 2007
4-9-3 Myojin-cho, Hachioji-shi, Tokyo 192-8566, Japan

WT5000, 30 A and 5 A High Accuracy Elements (760901 and 760902), and Current Sensor Element (760903) include LAZER source inside.

Features

The next-generation WT series that can flexibly respond to the ever-changing market needs with its world highest class accuracy, modular architecture and various filters.

- Excellent basic performance polished to details
 - Basic power accuracy: $\pm(0.01\%$ of reading + 0.02% of range)
 - Measurement bandwidth: Voltage DC to 10 MHz, Current DC to 5 MHz
 - Capture a slight value change in various condition of motor drive
- Functions to support high precision power measurement needs
- Simultaneous power measurement of up to 7 inputs
- Evaluation of up to 4 motors (optional)
- Max. 10 MS/s & 18 bits AD converter equipped
- Phase compensation function for sensors enables more accurate measurement.
- Continuous output of voltage and current waveforms at up to 2 MS/s to PC. Enables synchronous measurement of high-precision power values and high-speed sampling waveforms. (optional)
- Harmonic/flicker standard testing
- Up to 32 GB of non-volatile internal memory (optional)



Easy wiring and reliable high-precision large current measurements by using the current sensor element.



Users can install, remove or swap input elements themselves.

Model and Suffix Code

Model	Suffix Code	Description
WT5000		Precision Power Analyzer
Language Menu	-HC	Chinese/English Menu
	-HE	English Menu
	-HG	German/English Menu
	-HJ	Japanese/English Menu
Power Cord	-B	Indian Standard
	-D	UL/CSA Standard, PSE Compliant
	-F	VDE/Korean Standard
	-H	Chinese Standard
	-N	Brazilian Standard
	-Q	BS Standard
	-R	Australian Standard
	-T	Taiwanese Standard
	-U	IEC Plug Type B
Option	/M1	32 GB Built-in Memory
	/MTR1	Motor Evaluation 1
	/DA20*	20 CH D/A Output
	/MTR2*	Motor Evaluation 2
	/DS	Data Streaming
	/G7	IEC Harmonic/Flicker Measurement

*When select from these options, please select only one. /MTR2 option requires installation of /MTR1 option.

Model	Suffix Code	Description
760901		30 A High Accuracy Element
760902		5 A High Accuracy Element
760903		Current Sensor Element

Standard accessories

WT5000: Power cord, Rubber feet, Cover panel B8216JA 7 sets, User's manual, expanded user's manual, communication interface user's manual, connector (provided only with/DA20), 760901/760902: Safety terminal adapter B9317WB/B9317WC (provided two adapters in a set times input element number)*1, safety terminal adapter A1650JZ/A1651JZ (provided black/red two adapters in a set, times of 30 A input element number)*1, safety terminal adapter B8213YA/B8213YB (provided black/red two adapters in a set, times of 5 A input element number)*1
760903*2: Safety terminal adapter B9317WB/B9317WC (provided black/red two adapters in a set times input element number)*1

*1: When need above standard accessories additionally, order accessory products, 758931, 761951 and 761953. See Accessory list (P.43).

*2: Cable for current sensor is sold separately.

Functions

Unmatched accuracy

The WT5000 is the world's most accurate precision power analyzer with a basic power accuracy of $\pm 0.03\%$. Its accuracy specifications are guaranteed from 1% to 130% of the selected voltage and current ranges. With minimum influence of low-power factor (0.02% of apparent power) the unit is also accurate at large phase shifts and frequencies.

- AC power accuracy: 0.01% of reading + 0.02% of range
- DC power accuracy: 0.02% of reading + 0.05% of range
- 10 MS/s 18 bit ADC

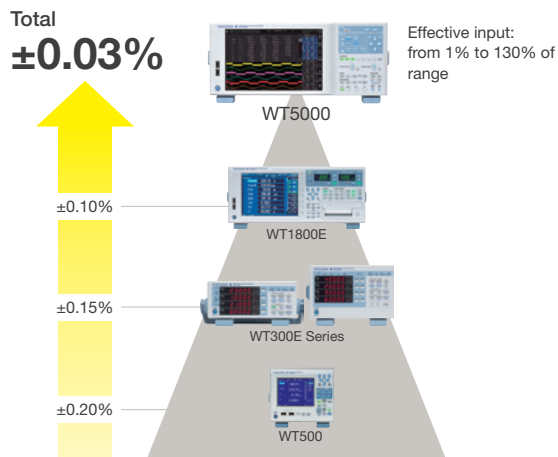

Multi-channel measurements

Measure from up to seven different power phases at 10 MS/s (18 bits). The high resolution, 10.1 inch WXGA display allows split screen viewing of up to seven waveforms and can display up to 12 pages of diverse measurement parameters, making it ideal for efficiency tests of inverter-driven motors, renewable energy technologies, and traction applications such as pumps, fans, and electric vehicles. Measurements are also displayed in vector format or trending in time.

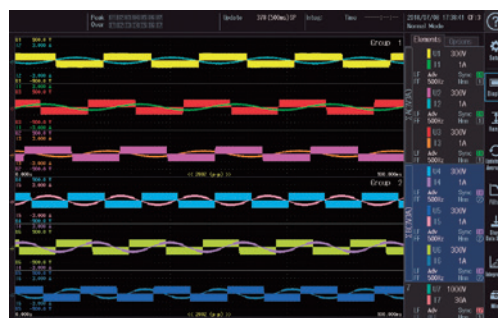

Current sensor module with DC power supply

Use of the internal DC power supply for AC/DC current sensors simplifies the preparations before measurement and the measurement setup only requires the current sensor and a connecting cable. Using an external DC power supply and additional wiring is no longer required. There are three sensor connection cable lengths available; i.e., 3 m, 5 m, and 10 m.

*Firmware version 3.01 or later is required.

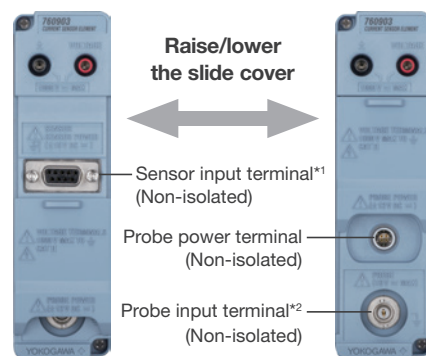
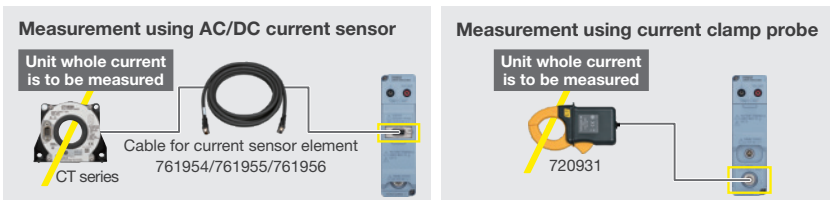

*1: The following AC/DC current sensors are available: CT60, CT200, CT1000, CT1000A, CT2000A

*2: The following current clamp probes are available: 720930, 720931

Characteristic example of the current sensor element

*These only shows 760903 current sensor element's characteristic.

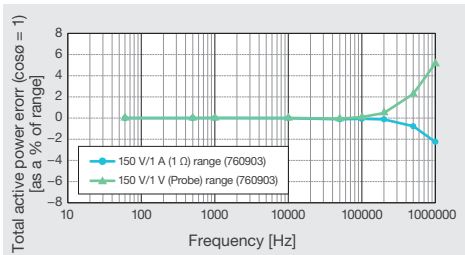

Frequency versus power accuracy at unity power factor

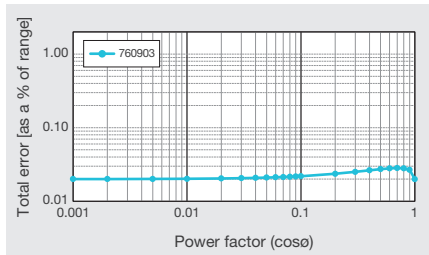

Total power error with rated range input for an arbitrary power factor (50/60 Hz)

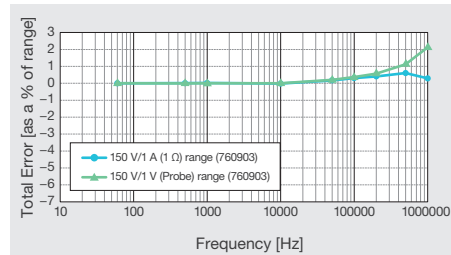

Frequency versus power accuracy at zero power factor

Phase correction

The WT5000 offers gain and phase correction functions for precision power measurement. In some applications, external sensors and probes are required to enable high-current measurement. In order to maximize accuracy during measurement, it is recommended to correct gain and phase error or calibrate the measurement setup.

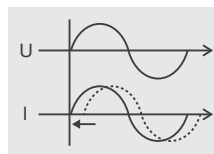
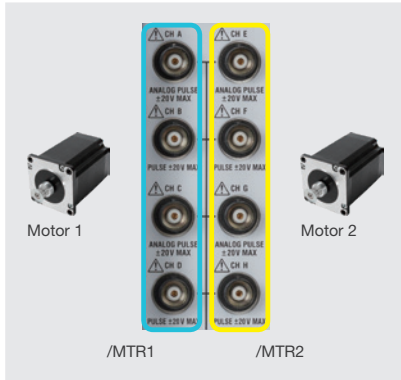

Image of phase shift of waveform

Evaluate motors, drives, and inverters

Measure more than just electrical parameters. The motor evaluation function enables measurements of rotational speed and direction, synchronous speed, slip, torque, mechanical power, electrical angle, and motor efficiency from an analog or pulse output of torque sensors or pulse outputs of rotation sensors.

Up to two motors can be measured per WT5000 when the determination of the rotation direction and the electrical angle is needed. A simple setting in the motor configuration menu allows a single WT5000 to take synchronous measurements from up to four torque and rotation sensors, enabling users to determine the overall efficiency from four-wheel driven vehicles.



A single WT5000 configured for simultaneous, synchronized measurements from two motors to determine torque, rotation speed, direction, and electrical angles of A/B and Z phases.

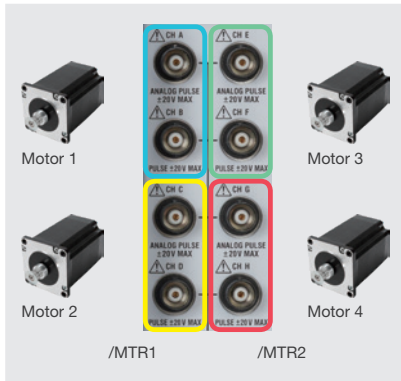

A single WT5000 configured for simultaneous synchronized measurements from four torque and rotation sensors to determine overall efficiency of four motors.

Advanced filtering

In addition to low pass frequency filters and line filters, the WT5000 features advanced filtering capabilities that provide unprecedented control to analyze even the toughest of waveforms with precision.

- Synchronization source filter: Instead of synchronizing to zero-crossings, users can select any specific point of the synchronization source signal.
- Enhanced frequency filter: Allows users to simultaneously measure fundamental and switching frequencies without influencing any other parameter.
- Digital parallel path filters: Supported by a high-frequency anti-aliasing filter, two separate line filters for normal and harmonic measurements ensure accuracy without aliasing in wideband and harmonic measurements. Users can limit the number of harmonic orders to eliminate attenuation in low-bandwidth measurements.



Raw waveform data streaming

In addition to benefitting from the highly accurate numerical data measured by the WT5000, one can stream to a PC the raw waveform data with a sample speed of up to 2 MS/s. Voltage and current waveforms as well as the motor signals can be streamed to a PC. This allows engineers to study the transient behavior simultaneously when measuring efficiency or energy consumption.

The raw waveform data is streamed without any gaps, can be combined, and is synchronized with the numerical data. Abnormal findings in numerical data can be directly linked and evaluated in the waveform data. For example, one can find numeric parameters variation caused by the influence of imposed high-frequency noise.

To stream the raw waveform data to a PC, it is possible to make use of IS8000. This can also be done by making use of dedicated communication commands for programming.



Display example of IS8000

Up to 32 GB of internal memory

The WT5000 offers up to 32 GB of internal storage memory that can be used to store and recall various custom configurations and test setups. It can also be used to log large amounts of measurement data over long periods of time, behaving just like a logger. This large non-volatile memory makes it easy to store data without preparing any external media. Save Waveform/Numeric/Screen Copy data or Setting Information.

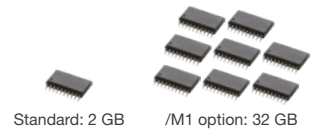

Standard: 2 GB /M1 option: 32 GB

Communications

Not only does the WT5000 support GP-IB, USB, and Ethernet communications, it is also backward compatible with communication commands of previous models.

Extend measurements with multi-unit synchronization

When synchronizing four WT5000s with one main unit and three sub units, there is access to 28 input elements for electrical power measurements and up to 16 motor evaluation functions. The WTViewerE software supports this performance.

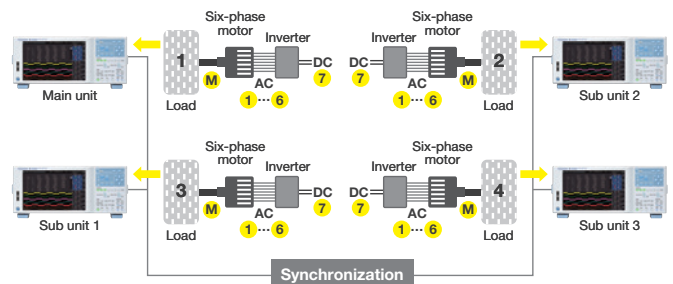

Applications

Electric Vehicle development

Between 16 to 18% of the total charge of an electric car is consumed by electric drive system losses. Electric and hybrid car manufacturers therefore need to accurately evaluate motor and inverter control in order to achieve higher precision and greater efficiency.

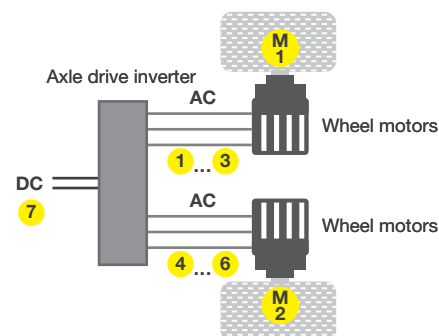
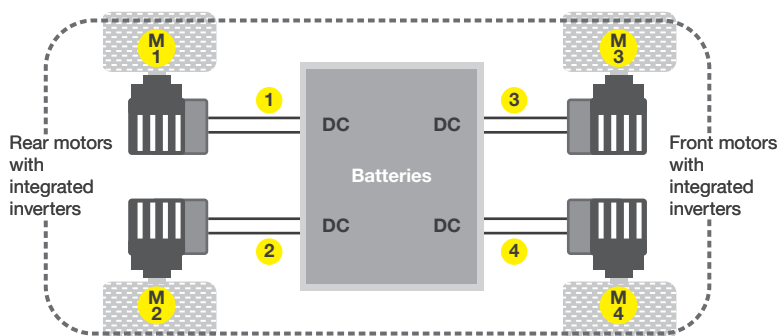

Case1:

Modern drive systems with integrated inverters do not allow access to the AC signals. Here one of the main measurement tasks is to measure the overall drive train efficiency from DC to mechanical power. The example shows 4 DC measurements (1 to 4) with the corresponding 4 mechanical power measurements (M1 to M4)

Case2:

Example of an axle power efficiency measurement from DC (7) to dual 3-phase AC (1 to 3 and 4 to 6) plus dual mechanical power (M1 and M2)

Key requirements

- Multi-phase measurements from battery, inverter and motor
- Evaluation of motor characteristics such as torque, rotation speed and direction, slip and electrical angle
- Battery charging/discharging characteristics
- Harmonic analysis of inverter signals at various rotation speeds

The WT5000 advantage

With high accuracy, multi-channel power measurements, evaluation of up to 4 motors and harmonic comparison capabilities, the WT5000 supports automotive engineers improve conversion efficiency, shorten charging times and improve driving range.

- Guaranteed accuracy in multichannel measurements
- Motor evaluation and mechatronic efficiency
- Battery charging & discharging characteristics
- Harmonics Analysis & comparisons

Renewable energy development

Energy generated by photovoltaic cell modules and wind turbines is converted from DC to AC by a power conditioner. Minimizing losses in these conversions is key to improving the efficiency of the overall energy system.

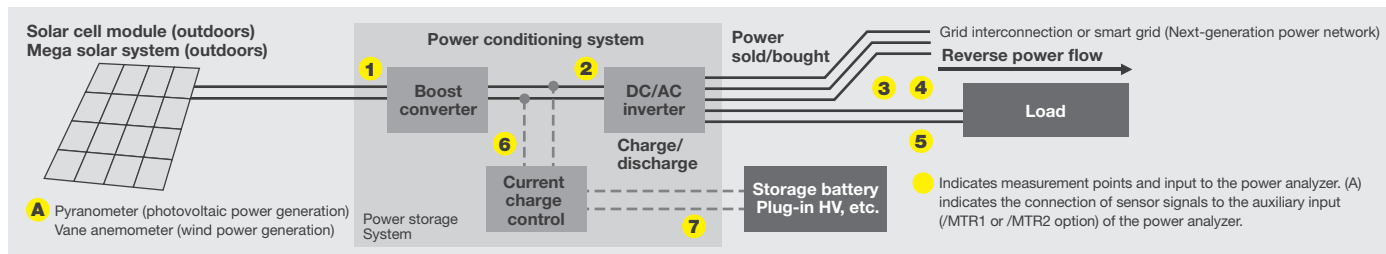

Key requirements

- Multi-phase measurements from boost converter, inverter, and storage battery
- Evaluation of maximum power and instantaneous peak values
- Energy bought and sold in grid
- Battery charging/discharging characteristics
- Harmonic analysis of inverter signals at various generator speeds

The WT5000 advantage

The WT5000 helps engineers working in the development of renewable energy solutions, to improve conversion efficiency by offering precision insights in charging, discharging, storage, and overall efficiency.

- Multi-channel power measurements
- Instantaneous peak power
- Energy bought/sold and charged/discharged
- Harmonics analysis and comparisons

Harmonic limits compliance test for EV/PHV charging

Combined with the /G7 option and the Harmonic /Flicker measurement software, the WT5000 measured harmonic data can be saved into a PC and judge the level according to IEC regulations. To support large equipment over 16 A/phase (IEC61000-3-12), the special CT200 current sensor model can be used.

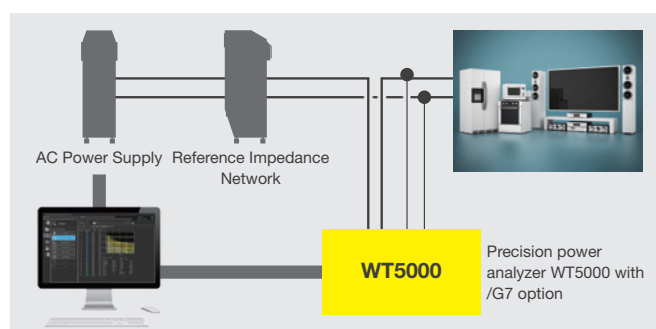

Broad Ranges Power Measurement with One Unit

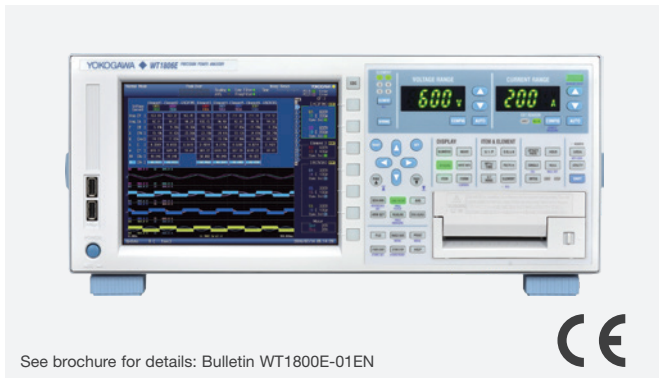

See brochure for details: Bulletin WT1800E-01EN

Overview

The WT1800E High performance power analyzer can measure both the small currents of products called energy saving designed as well as the large currents involved in large-sized loads. As it handles voltages ranging from 1.5 V to 1000 V, it has a wide variety of uses. Since 3 phase power can be input from two separate systems (6 inputs), you only need one WT1800E to simultaneously measure Input/Output signals from inverters with normal/harmonics data as fast as 50 ms.

- Basic Power Accuracy: $\pm 0.1\%$ of total
- DC Power Accuracy: $\pm 0.1\%$ of total
- Voltage/Current Bandwidth: 5 MHz (-3 dB, typical)
Voltage, 5 A direct input, external sensor input
- Sampling Rate: 2 MS/s (16-bit resolution)
- Input Element number: Maximum 6
- Current Measurement: 100 μ A to 55 Arms direct

DC power supply for AC/DC current sensors (/PD2 option)

The WT1800E can be equipped with a DC power supply for the CT series of AC/DC current sensors. By using dedicated connection cables and shunt resistors, the WT1800E can measure large currents. Improved S/N ratio and noise immunity is achieved by connecting the sensors in this way.

*EX1 to /EX6 options must be installed in the WT1800E to be able to use the Shunt Resistor Box.



Applications

Motor and Drive Testing

Wide bandwidth and High speed sampling

The WT1800E is capable of 16-bit high resolution and 2 MHz sampling making it possible to measure faster signals with higher precision.

Motor evaluation: Electrical angle/rotation/direction

Measure rotation speed, torque, and output (mechanical power) of motors from analog/pulse inputs of rotation or torque sensors.

Harmonics and dual harmonics

Simultaneously measure distortion factors like THD, fundamental and harmonic components. Harmonics up to the 500th order can be measured even at 50 ms data update rate. Users can also measure harmonics on two different sources simultaneously.

Line filter to remove high frequency components

In the power evaluation of inverter waveforms, measurement values are affected by high frequency components. A digital filter function makes it possible to remove unnecessary high frequency components superimposed on signals. The filter can be independently set for each input element.

An analog filter for 1 MHz/300 kHz, and a digital filter that can be set from 100 Hz to 100 kHz in increments of 100 Hz are available as standard.

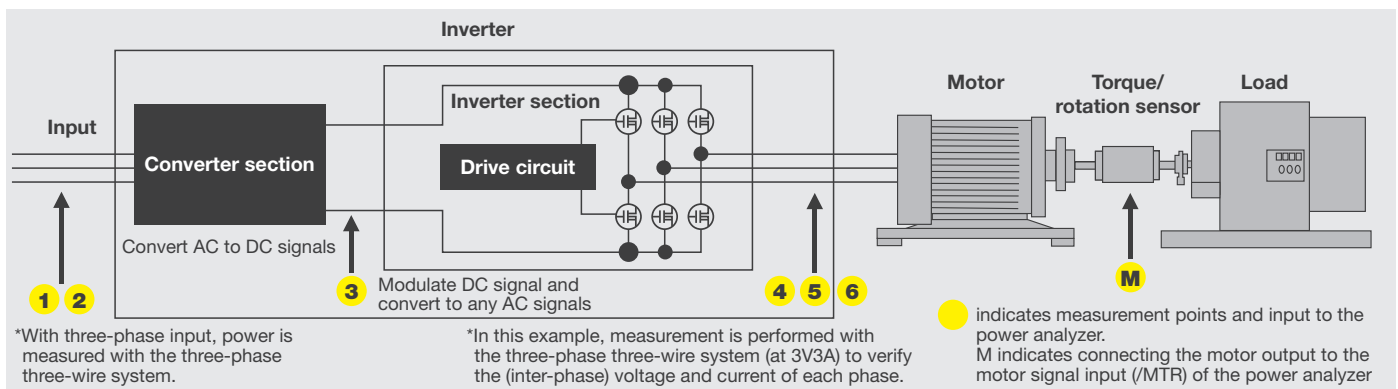

Inverter/Converter Testing for Renewable Energy

Multiple channels and wide input range

Evaluate Power conditioner efficiency using 6 input channels for simultaneous measurements from the inputs and outputs of boost converter, inverter, and storage battery. Direct input terminals (voltage range: 1.5 V to 1000 V and current range: 10 mA to 5 A or 1 A to 50 A) make it possible to perform high-precision measurements without using a current sensor.

In addition, two units can be operated in synchronization for multi-channel power evaluation.

Measuring instantaneous peak power

In photovoltaic power generation, an MPPT control varies the voltage to maximize energy harvested from the solar panel. The WT1800E is capable of measuring not only the voltage, current, and power but also the voltage, current, and power peak values for both plus (+) and minus (-) sides.

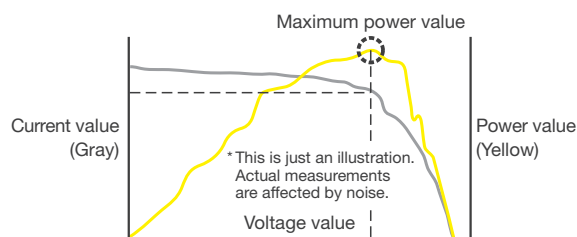

Typical voltage, current, and power measurements in MPPT control

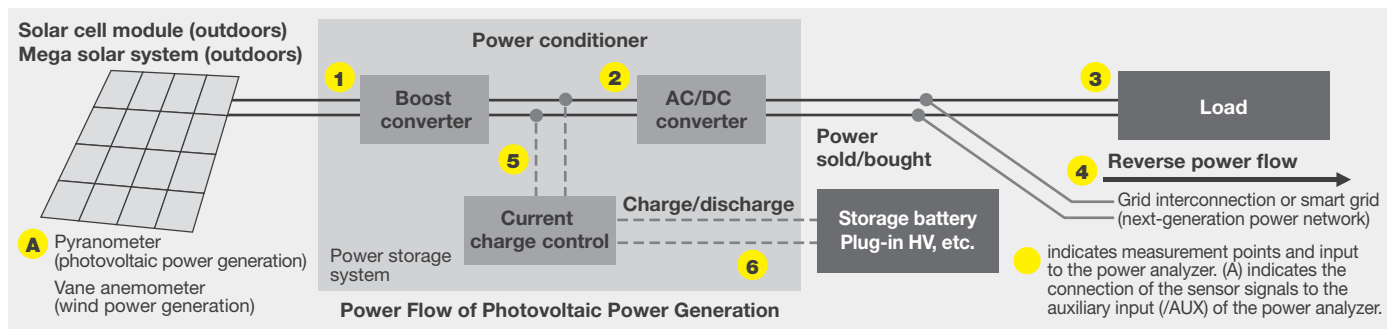

Specifications

Measurement Voltage range (for Crest factor 3)	1.5/3/6/10/15/30/60/100/150/300/600/1000 V
Measurement Direct Current range (for Crest factor 3)	5 A input element 10 m/20 m/50 m/100 m/200 m/500 m/1/2/5 A
	50 A input element 1/2/5/10/20/50 A
Measurement External Current Sensor range (for Crest Factor 3)	50 m/100 m/200 m/500 m/1/2/5/10 V
Band width	DC, 0.1 Hz to 1 MHz (5 A direct Current input, External Current Sensor input) DC, 0.1 Hz to 200 kHz (50 A direct Current input)
Basic Accuracy (45 Hz ≤ f ≤ 66 Hz)	±(0.05% of reading + 0.05% of range)
DC Accuracy	±(0.05% of reading + 0.05% of range)
A/D converter	Sampling frequency 2 MS/s, Resolution 16 bit
External dimensions	Approx. 426 (W) × 177 (H) × 459 (D) mm Approx. 426 (W) × 221 (H) × 459 (D) mm (with /PD2 option)
Weight	Approx. 15 kg (with 6-input element)

*5 A and 50 A Input Element can be installed in one unit

Model and Suffix Code

Model	Suffix Code	Description
One input element model		
WT1801E	-5A0-50A1	50 A × 1 Input Element
	-5A1-50A0	5 A × 1 Input Element
Two input elements model		
WT1802E	-5A0-50A2	50 A × 2 Input Elements
	-5A1-50A1	5 A × 1 Input Element 50 A × 1 Input Element
	-5A2-50A0	5 A × 2 Input Elements
Three input elements model		
WT1803E	-5A0-50A3	50 A × 3 Input Elements
	-5A1-50A2	5 A × 1 Input Element 50 A × 2 Input Elements
	-5A2-50A1	5 A × 2 Input Elements 50 A × 1 Input Element
	-5A3-50A0	5 A × 3 Input Elements
Four input elements model		
WT1804E	-5A0-50A4	50 A × 4 Input Elements
	-5A1-50A3	5 A × 1 Input Element 50 A × 3 Input Elements
	-5A2-50A2	5 A × 2 Input Elements 50 A × 2 Input Elements
	-5A3-50A1	5 A × 3 Input Elements 50 A × 1 Input Element
	-5A4-50A0	5 A × 4 Input Elements

Model	Suffix Code	Description
Five input elements model		
WT1805E	-5A0-50A5	50 A × 5 Input Elements
	-5A1-50A4	5 A × 1 Input Element 50 A × 4 Input Elements
	-5A2-50A3	5 A × 2 Input Elements 50 A × 3 Input Elements
	-5A3-50A2	5 A × 3 Input Elements 50 A × 2 Input Elements
	-5A4-50A1	5 A × 4 Input Elements 50 A × 1 Input Element
	-5A5-50A0	5 A × 5 Input Elements
Six input elements model		
WT1806E	-5A0-50A6	50 A × 6 Input Elements
	-5A1-50A5	5 A × 1 Input Element 50 A × 5 Input Elements
	-5A2-50A4	5 A × 2 Input Elements 50 A × 4 Input Elements
	-5A3-50A3	5 A × 3 Input Elements 50 A × 3 Input Elements
	-5A4-50A2	5 A × 4 Input Elements 50 A × 2 Input Elements
	-5A5-50A1	5 A × 5 Input Elements 50 A × 1 Input Element
-5A6-50A0	5 A × 6 Input Elements	

Standard Options		
Menu Language	-HC	Chinese/English
	-HE	English/Japanese
	-HG	German/English
	-HR	Russian/English
Power Cord	-B	Indian Standard
	-D	UL/CSA Standard PSE compliant
	-F	VDE Standard
	-H	GB Standard
	-N	NBR Standard
	-Q	BS Standard
	-R	AS Standard
	-T	Taiwanese Standard
	-U	IEC Plug Type B

Additional Options		
Option	/EX1 ^{*1}	External Current Sensor Input for WT1801E
	/EX2 ^{*1}	External Current Sensor Input for WT1802E
	/EX3 ^{*1}	External Current Sensor Input for WT1803E
	/EX4 ^{*1}	External Current Sensor Input for WT1804E
	/EX5 ^{*1}	External Current Sensor Input for WT1805E
	/EX6 ^{*1}	External Current Sensor Input for WT1806E
	/B5	Built-in Printer
	/G5 ^{*2}	Harmonic Measurement
	/G6 ^{*2}	Simultaneous Dual Harmonics (except for WT1801E)
	/V1	RGB Output
	/DA	20-Channel D/A Output
	/MTR ^{*3}	Motor Evaluation Function
	/AUX ^{*3}	2-Channel Auxiliary Input
	/PD2 ^{*4}	6-Channel Current Sensor Power

*1, *4: When use Shunt Resistor Box for measurement, both /EX1 to /EX6 and /PD2 options are required. *2, *3: When select these functions, please specify only one. *4: /PD2 option requires Firmware version Ver. 3.1 or later.

Useful in the Development of Home Appliances and Office Equipment as well as in the Measurement of Power Consumption and Standby Power on Production Line



See brochure for details: Bulletin WT300E-01EN

Specifications

Direct voltage input range	15/30/60/150/300/600 V
Direct current input range	5/10/20/50/100/200 mA (WT310E only) 0.5/1/2/5/10/20 A (Common for WT300E series) 1/2/5/10/20/40 A (WT310EH only)
External sensor input range (optional)	2.5/5/10 V or 50 m/100 m/200 m/500 m/1/2 V
Frequency range	DC, 0.1 Hz to 100 kHz (up to 20 kHz for WT310EH)
Basic accuracy (45 Hz to 66 Hz)	Voltage/current $\pm(0.1\% \text{ of reading} + 0.05\% \text{ of range})$ Power $\pm(0.1\% \text{ of reading} + 0.05\% \text{ of range})$
Influence of power factor (when $\cos \phi = 0$)	Add $\pm 0.1\%$ of S
Data update rate	100 m/250 m/500 m/1/2/5/10/20 s, Auto
External dimensions	WT310E/WT310EH Approx. 213 (W) \times 88 (H) \times 379 (D) mm (excluding protrusions) WT332E/WT333E Approx. 213 (W) \times 132 (H) \times 379 (D) mm (excluding protrusions)
Weight	WT310E/WT310EH Approx. 3.0 kg WT332E/WT333E Approx. 5.0 kg

Features

- Basic power accuracy: $\pm 0.15\%$ of total
- Measurement frequency range: DC, 0.1 Hz to 100 kHz (to 20 kHz for WT310EH)
- Fast data update rate: 100 ms
- Auto data update rate function for fluctuating input
- Small current measurement: 5 mA range (WT310E)
- 40 A large current range (WT310EH)
- Multiple communication interfaces: USB, GP-IB or RS-232 and Ethernet (option and supports the Modbus/TCP Protocol)
- Integration energy measurement with auto ranging function
- Simultaneous harmonics measurement of voltage, current, and power (mode switching is not required, but the included PC software is required)
- Compact half-rack mount size
- The included standard PC software allows you to display values, harmonic bar graph, and waveforms

New Functions to Improve Measurement Efficiency

Range skip (range configuration) function

The WT300E series is equipped with the range skip (range configuration) function of the high-end models, which reduces the range-change time in auto-ranging mode that is long due to the wide voltage and current ranges. This function skips the ranges other than the pre-selected range to speed up the change to the selected range in auto-ranging mode. (The included WTVIEWERFreePlus software is required for the setting)

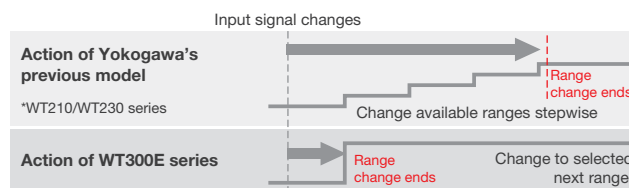

Image of Range skip (configuration) function operation

Integration measurement auto-ranging function

This is the industry's first function to automatically change the range in response to changes of the consumption power and current values in integration mode. This function continues integration even if the level of the input exceeds the maximum of the selected range and the range is changed to a higher level as a result of a rapid change in the conditions. This function eliminates the need for repeating the test even if a range is exceeded, thus reducing the evaluation time. Furthermore, separate power integration for each polarity ($\pm Wh$), current integration (Ah), and DC integration (charge/discharge) are also available.

(The measurement accuracy depends on the input level and variation. It is recommended to set a fast data update rate.)

WTVIEWERFreePlus For WT300E series (included)

The WTVIEWERFreePlus software installed on a PC uses a USB, GP-IB/RS-232, or Ethernet (optional) interface to capture, transfer, and display* five or more numeric values, bar graph of harmonic order components, trend graph of measurement data, or voltage/current waveforms that cannot be displayed on the LED display of the WT300E series. The use of this software extends the application range of the WT300E series.

With the aim of simplifying the connection and setup, the details were redesigned so that the communication function is recognized automatically, a dedicated setting window was added, and all measurement data can be displayed simultaneously.

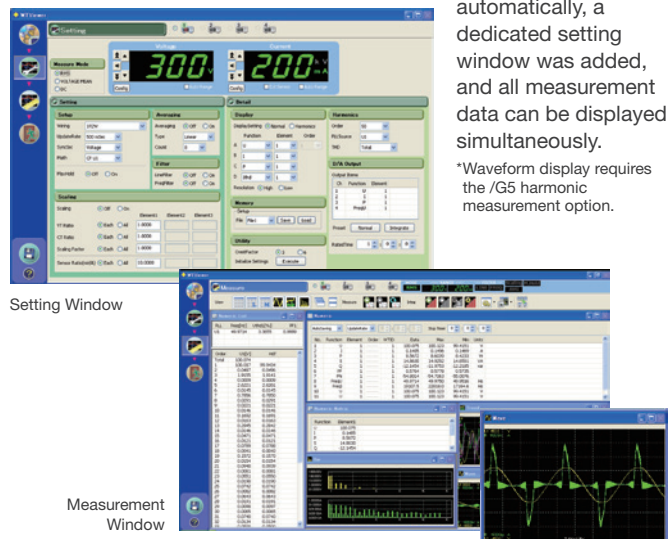

*Waveform display requires the /G5 harmonic measurement option.

Applications

Production line or QA testing of electric Devices

- Compact half rack mount size helps customers build smaller test systems with a better Return on Investment (ROI).
- D/A output function and Modbus/TCP Protocol (/C7 option) for data recording
- Multiple communication interfaces. USB, RS-232 or GP-IB and Ethernet capability

The simultaneous measurement of power consumption parameters such as U, I, P, frequency, Power Factor and Harmonics for production line or QA testing results in reduced tact times. Thus testing is faster and cheaper. The DA output and communication interfaces enable data to be remotely and flexibly captured.

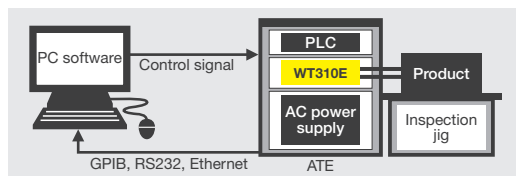

Duration testing and efficiency measurement for industrial motors and rotating machinery

- Integration measurement for long period
- D/A output function and Modbus/TCP Protocol (/C7 option) for data recording
- DC, 0.1 Hz to 100 kHz broad bandwidth capability

The WT300E series provides reliable current integration (Ah) and Energy (Wh) measurement for up to 10000 hours (approx. 1 year). The D/A option is used to save and monitor the measurement results (WT310E/WT310EH: 4 ch, WT332E/WT333E: 12 ch). An external recorder or data logger like, a ScopeCorder, can be used to save this D/A function data along with other parameters such as temperatures, torque and rotation speed.

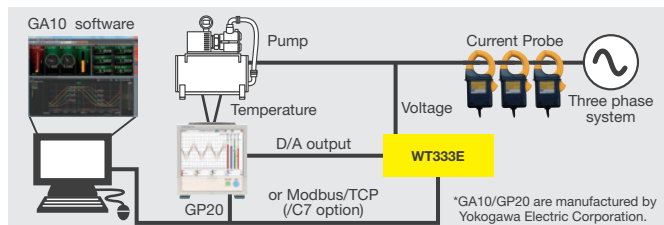

Model and Suffix Code

Model	Suffix Code	Description	
WT310E		1 Input element model	
WT310EH		1 Input element /High current model	
Communication Interface	-C1	select one GP- IB	
	-C2	RS- 232	
	Power Cord	-B	Indian Standard
		-D	UL, CSA standard, PSE compliant
		-F	VDE standard
		-R	AS standard
		-Q	BS standard
		-H	GB standard
		-N	NBR standard
		-T	Taiwanese standard
		-U	IEC Plug Type B
		Optional function	/C7
/EX1	*1 External sensor input 2.5 V/5 V/10 V		
/EX2	*1 External sensor input 50 mV/100 mV/200 mV/500 mV/1 V/2 V		
/G5	Harmonics Measurement		
/DA4	D/A- output (4 CH)		
WT332E		2 Input elements model	
WT333E		3 Input elements model	
Communication Interface	-C1	select one GP- IB	
	-C2	RS- 232	
Power Cord	-B	Indian Standard	
	-D	UL, CSA standard, PSE compliant	
	-F	VDE standard	
	-R	AS standard	
	-Q	BS standard	
	-H	GB standard	
	-N	NBR standard	
	-T	Taiwanese standard	
	-U	IEC Plug Type B	
	Optional function	/C7	Ethernet interface
/EX1		*1 External sensor input 2.5 V/5 V/10 V	
/EX2		*1 External sensor input 50 mV/100 mV/200 mV/500 mV/1 V/2 V	
/G5		Harmonics Measurement	
/DA12		D/A- output (12 CH)	

Standard accessories
 Power cord (1 set), Rubber foot (1 set), Current input protective cover (each 1 set), Start up guide (1 set), Connector (provided only with /DA4 or /DA12, each 1 set), Safety terminal adapter 758931(provided two adapters in a set times input element number), CD (1 piece, included the startup guide, user guide, instruction manual and the communication manual by PDF data, and Viewer Software)
 *1 Only one of these can be selected at a time.

Comparison between WT210/230 series, WT300 series and WT300E series

	Enhancement points from the WT310/WT330	Changed points from the WT210/WT230
Basic power measurement accuracy (50/60 Hz)	0.1% of reading + 0.05% of range	0.1% of reading + 0.1% of range
Influence of power factor	When power factor (λ) = 0 (S: apparent power) ±0.1% of S for 45 Hz ≤ f ≤ 66 Hz	When power factor (λ) = 0 (S: apparent power) ±0.2% of S for 45 Hz ≤ f ≤ 66 Hz
Frequency bandwidth	DC, 0.1 Hz to 100 kHz (WT310EH DC, 0.1 Hz to 20 kHz)	DC, 0.5 Hz to 100 kHz (WT310HC DC, 0.5 Hz to 20 kHz)
Direct input Current range	WT310E: 12 ranges/5 mA to 20 A, WT310EH: 6 ranges/1 to 40 A WT332E/WT333E: 6 ranges/0.5 to 20 A	WT310: 12 ranges/5 mA to 20 A, WT310HC: 6 ranges/1 to 40 A WT332/WT333: 6 ranges/0.5 to 20 A
External current input	EX1: 2.5/5/10 [V] EX2: 50 m/100 m/200 m/500 m/1/2 [V] (OP.)	EX1: 2.5/5/10 [V] EX2: 50 m/100 m/200 m/500 m/1/2 [V] (OP.)
Expansion of effective input range for voltage & current (CF = 6A)	2% to 260%*1	No
Expansion of maximum displaying value for voltage & current (CF = 6A)	2% to 280%*2	No
Simultaneous measurement of RMS, Voltage MEAN & DC	Yes*3	No
Frequency measurement	2 channels (voltage and current)	2 channels (voltage and current)
Number of display item	4 items	selected voltage or current (one) 3 items
Sampling rate	Approximately 100 kS/s	Approximately 100 kS/s
Data Update rate	100 m/250 m/500 m/1/2/5/10/20 s, Auto	100 m/250 m/500 m/1/2/5 s
Harmonic measurement	Yes (OP, /G5)	Yes (OP, /HRM)
THD calculation maximum order setting	Yes (OP, 1 to 50th)	Yes (OP, 1 to 50th)
Auto ranging of integration	Yes	No
Communication interface	USB	Yes
	GP-IB	Yes GP-IB or RS-232
	RS-232	Yes GP-IB or RS-232
	Ethernet	Yes (OP)
IEEE standard for GP-IB	Yes (OP, /C7)	No
	IEEE488.2	IEEE488.2
Comparator function	Yes	Yes
Viewer software (setting & data capturing)	Free (included)	Free (download)

*1: WT310EH input range is 2% to 260% (20 A range only up to 200%)
 *2: WT310EH input range is 2% to 280% (20 A range only up to 220%)
 *3: Simultaneous, mode independent measurement using the WTViewerFreePlus PC software.

*A command compatible mode for the previous WT200 series is prepared. (IEEE488.2 only)
 In that mode, the WT300E series and WT300 series works identically to a WT200 series except for the Store (and recall operation) and the Compare functions.
 *Modbus/TCP communication requires /C7 Ethernet option.

Power Analyzer Capable of Measuring Waveform Parameters and Transient Power



See brochure for details: Bulletin PX8000-01EN

The PX8000 is a compact sophisticated power analyzer that can incorporate up to four measurement power elements. It can calculate the transient voltage, current, and power for each cycle, the average voltage, current, and power between cursors, and measure waveform parameters.

Features

- High-speed sampling and wide range measurement**
 The power of devices driven at a high frequency can be measured at a 100 MS/s sampling rate, at a 12-bit resolution, and in the 20 MHz range^{*1}. *1: Direct current input at 10 MHz (-3 dB typical)
- Waveform measurement function**
 Instantaneous power waveforms can be displayed as standard in addition to voltage and current waveforms, and power changes can be observed directly. Voltage, current, and power waveforms for each cycle can be calculated and numerical values can be displayed by cursor. The average voltage, current, and power values in a specified period by the cursor can be calculated. Acquisition memory is up to 100 M points per channel (when equipping the /M2 option), allowing for capturing and displaying detailed waveforms.
- Waveform analysis function**
 Up to the 500th order harmonic components can be measured simultaneously (when installing the /G5 option). 2-channel FFT function is available as standard.
- De-skew (phase compensation) function** when using an external current sensor, etc. is available.
- Motor characteristics** can be evaluated (mechanical output calculation with torque and rotation speed input, as well as analog and pulse input).

Power measurement elements (voltage and current modules) and Auxiliary (AUX) module

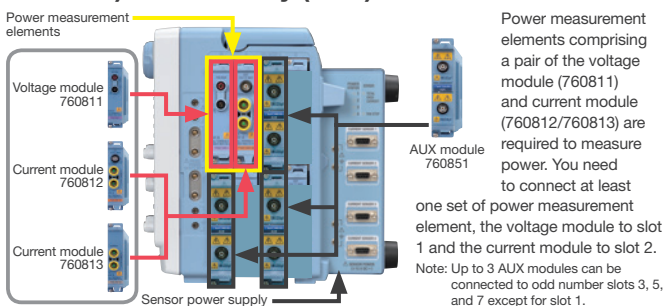

Safety design

Different types of voltage input terminal and current input terminal are used to keep the user from confusing one from the other.

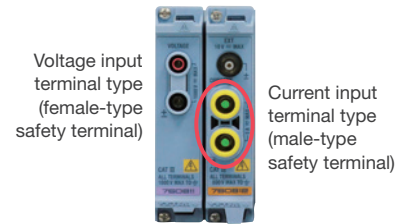

Various functions to measure transient power^{*2}

*2: Accuracy is not specified for the numerical data of the measured transient power.

Simultaneous calculation and display of instantaneous power waveforms

The PX8000 calculates the instantaneous power waveform simultaneously with the voltage and current waveforms. The instantaneous waveform can be obtained as the product of the voltage and current waveforms that are sampled at the same time. This function is a standard function so no special setting is required. This instantaneous power value can be displayed using the cursor.

Waveform data in the displayed entire range can be displayed on the numerical display screen.

The instantaneous power waveform indicates the trend of power change. The value at any point in time can be displayed using the cursor.

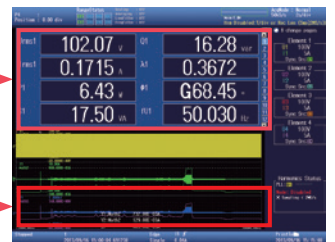

Trend power calculation for each cycle

Power trend waveform for each cycle can be calculated using the User Defined Computation (waveform calculation, MATH) at up to 4 M points. The captured waveforms can be used to obtain the value for a particular cycle and calculate the difference between cycles using the cursor function.

Settings of the trend calculation using the User Defined Computation (MATH) function.

The cursor (horizontal, vertical, and marker) allows you to display the numerical data of trend waveform for each cycle calculated using the User Defined Calculation (MATH).



Power calculation in a range specified by the cursor

The average numerical values in a range specified by the cursor can be calculated. Values between cursors of waveforms displayed on the screen can be displayed on the upper numerical display screen. The MEASURE function cursor can be used for the measurement in the specified range.

Waveform parameters to be calculated can be set in detail.

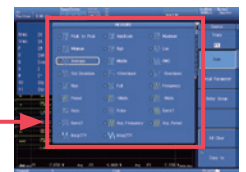

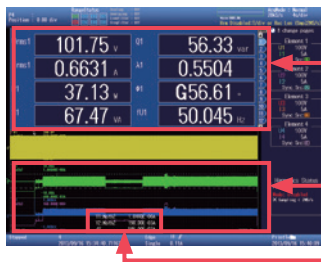

Measured values of waveforms displayed between cursors indicating the start and stop positions can be displayed on the numerical display screen.

Measured values between the cursors indicating the start/stop position can also be set independently of measured values obtained on the numeric display.

Displaying result of automated measurement of waveform parameters.

Viewer software PowerViewerPlus

A PC application software for the PX8000, 760881 PowerViewerPlus allows you to transfer measurement data of the PX8000 to a PC to display and analyze a large amount of waveform data on the PC.

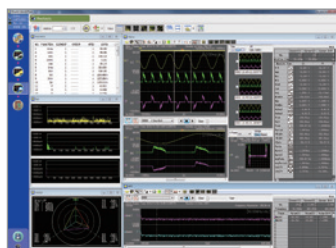

Measurement results display screen

Applications

Application example: Inverter evaluation using the PX8000 and DL950

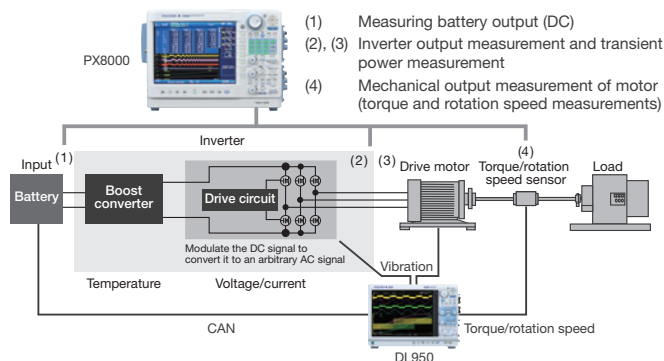

Overview of the evaluation with the PX8000 and DL950

Electric vehicles (EVs) and hybrid electric vehicles (HEV) are made of a large number of electrical and mechanical parts. To evaluate their efficiency, electrical parts and mechanical parts must be measurement simultaneously. The DL950 is a data acquisition instrument that can measure many types of physical quantities at multiple points simultaneously. On the other hand, the PX8000 measures the efficiency of the inverter and the motor, as well as transient changes at every moment based on the electrical signals of voltage and current and the mechanical output calculated from the torque and rotation speed.

Specifications

Voltage direct input range	1.5/3/6/10/15/30/60/100/150/300/600/1000 Vrms
Current direct input range	10 m/20 m/50 m/100 m/200 m/500 m/1/2/5 Arms
Current sensor input range	50 m/100 m/200 m/500 m/1/2/5/10 Vrms
Frequency range	DC to 20 MHz (−3 dB, voltage and current sensor input), DC to 10 MHz (−3 dB, current direct input)
Power basic accuracy (45 Hz to 66 Hz)	±(0.1% of reading + 0.1% of range)
Influence of power factor error (cos ϕ = 0)	±0.15% of S (apparent power)
A/D converter	Maximum sampling rate 100 MS/s, Resolution 12-bit
Acquisition memory	Standard: 10 M points per channel Max: 100 M points per channel (/M2 option)
Maximum waveform viewing time	20 minutes (not dependent on the memory size)
History memory	This function can save up to 1000 records of waveform data and display and calculate them as needed (when the /M2 option installed)

Waveform display	Up to 16 waveforms can be displayed. Voltage and current waveforms and simultaneous power waveform can be displayed.
Snapshot	Waveform at an arbitrary moment on the screen can be saved.
De-skew (phase compensation) function	Phase difference between the voltage and current modules is compensated.
Trend measurement (waveform measurement, MATH)	Voltage, current, and power waveform calculation for each cycle
Calculation in the specified period (waveform parameter calculation, MEASURE)	Average value between cursors can be measured.
Simultaneous harmonic measurement	Up to the 500th order harmonic measurement (/G5 option)
2-channel FFT function	Available as standard
Printer	Screens can be copied (/B5 option)
External storage	USB port (x2), SD card
Video output	RGB analog, video output
Display unit	10.4-inch color TFT XGA display
Interface	GP-IB, Ethernet, and USB communication available as standard
IRIG function	Data measured with multiple PX8000 units can be synchronized (/C20 option)
Sensor power supply	4CH DC power supply ± 15 Vdc Max. of 1.8 A/CH
External dimensions	355 (W) \times 259 (H) \times 180 (D) mm (excluding protrusions)
Weight	Approximately 6.5 kg (main unit only, excluding paper and options)

*For common options and accessories, see Model and suffix code.

Model and Suffix Code

Model	Suffix Code	Description
PX8000		Precision Power Scope main unit
Power	-B	Indian Standard
Cord	-D	UL and CSA standards (PSE compliant, 3-pole type)
	-F	VDE standard
	-R	AS standard
	-Q	BS standard
	-H	GB standard
	-N	NBR standard
	-U	IEC Plug Type B
	-HE	English menu language
	/B5	Built-in printer
	/C20	IRIG function
	/G5	Simultaneous harmonic measurement
	/M1 ¹	50 M point/CH memory extension
	/M2 ¹	100 M point/CH memory extension
	/P4	4 CH probe power output
	/PD2	4 CH sensor power output ²

Model	Description
760811 ³	Voltage Module Necessary to order the same number as that of the 760812/760813 Current Modules at the same time
760812 ³	Current Module Necessary to order the same number of that of the 760811 Voltage Modules at the same time
760813 ³	Current Module Necessary to order the same number of that of the 760811 Voltage Modules at the same time The 760813 is direct current input only
760851	Auxiliary (AUX) Module Can measure the sensor signals of torque and rotation speed on 2 channels

¹ Selection of both /M1 and /M2 is not available for one main frame. The standard memory length is 10 M points/CH.

² When use Shunt resistor Box for measurement, /PD2 option and Current module 760812 are required. The /PD2 option requires Firmware version Ver 3.2 or later.

³ The power value will be calibrated using a pair of Voltage (760811) and Current (760812/760813) modules, therefore an equal quantity of these must be ordered together.

Model	Description
760881	Power Viewer Plus Dedicated PC application software for PX8000 It is a waveform data analysis software

CLASS 1 LASER PRODUCT
クラス1レーザー製品
1类レーザー製品
(EN 60825-1:2014 + A11:2021)
(IEC 60825-1:2007, GB 7247.1-2012)

Complies with 21 CFR 1040.10 and 1040.11 except for deviations pursuant to Laser Notice No.50, dated June 24, 2007
4-9-8 Myojin-cho, Hachioji-shi, Tokyo 192-8566, Japan

Safety Precautions for Laser Products
The voltage module (760811), the current modules (760812/760813) and the AUX module (760851) uses laser light sources internally. These modules or respond to Class 1 laser product as defined in the IEC60825-1: 2007 Safety of Laser Products-Part 1: Equipment Classification and Requirements.

AC/DC Current Sensor CT60/CT200/CT1000/CT1000A/CT2000A

Wide Variety of Precision Current Sensors for Broad Applications

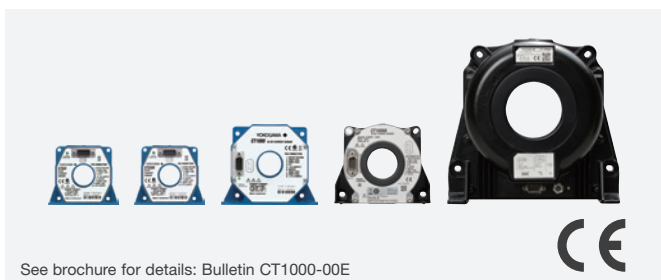

See brochure for details: Bulletin CT1000-00E

Features

The WT1800E and the PX8000 provide a power supply (/PD2 option) for the CTseries current sensor. It's easy to connect with the dedicated cable.

Specifications

Model	Frequency bandwidth	Basic accuracy	Rated current
CT2000A	DC to 40 kHz (-3 dB)	±(0.05% of reading + 30 μA)	2000 Arms (3000 Apeak)
CT1000A	DC to 300 kHz (-3 dB)	±(0.04% of reading + 30 μA)	1000 Arms (1500 Apeak)
CT1000	DC to 300 kHz (-3 dB)	±(0.05% of reading + 30 μA)	1000 Apeak
CT200	DC to 500 kHz (-3 dB)	±(0.05% of reading + 30 μA)	200 Apeak
CT60	DC to 800 kHz (-3 dB)	±(0.05% of reading + 30 μA)	60 Apeak

Model and Suffix Code

Model	Description
CT2000A	AC/DC Current sensor
CT1000A	AC/DC Current sensor
CT1000	AC/DC Current sensor
CT200	AC/DC Current sensor
CT60	AC/DC Current sensor

Current Probe 751552

Accessory for Digital Power Meters and Power Analyzer



See brochure for details: Bulletin CT1000-00E

Specifications

Measurement bandwidth	30 Hz to 5 kHz	To connect this probe to the WT series, you need the Model 758921 (Fork terminal adapter) and Model 758917 (Measurement lead set) accessories sold separately. For details, please see the Power Meter Accessories Catalog (Bulletin CT1000-00E).
Basic accuracy	±0.3% of reading	
Maximum allowable input	AC 1000 Arms, 1400 Apk (AC)	
Current output type	1 mA/A	

Model and Suffix Code

Model	Description
751552	Current Clamp-on Probe

Current Sensor Unit 751522/751524

Accessories for Digital Power Meters and Power Analyzers



See brochure for details: Bulletin CT1000-00E

Model and Suffix Code

Model	Suffix Code	Description	
751522		Current Sensor Unit (For Single-Phase)	
751524	-10	Current Sensor Unit (For Three-Phase U and V)	Measurement range: DC to 100 kHz Basic accuracy: ±(0.05% of reading + 40 μA)
	-20	Current Sensor Unit (For Three-Phase U and W)	
	-30	Current Sensor Unit (For Three-Phase U, V, and W)	
Input Terminal	-TS	Short Terminal Model	M12 × 1
	-TM	Middle Terminal Model	M12 × 1
	-TL	Long Terminal Model	M12 × 4
Power cord	-D	UL/CSA Standard, PSE Compliant	
	-F	VDE Standard	
	-R	AS Standard	
	-Q	BS Standard	
	-H	GB Standard	
	-N	NBR Standard	
Option	/CV	Terminal Cover	*Correspond to Input Terminal "-TS" only

*751524-10 is available for the WT3000E/WT1800E/WT500, and 751524-20 is available for the WT332E. 751522/751524 do not conform to CE Marking.

Specifications

Input type	Floating input using CT(s)
Rated currents	DC: 0 to 1000 A, AC: 1000 Apeak
Input/output ratio	1500:1
Guarantee accuracy period	12 months
Amplitude accuracy (within three months of calibration)	±(0.05% of reading + 40 μA) DC ±(0.1% of reading + 40 μA) (30 Hz ≤ f < 45 Hz) ±(0.05% of reading + 40 μA) (45 Hz ≤ f ≤ 66 Hz) ±(0.1% of reading + 40 μA) (66 Hz < f ≤ 1 kHz) ±((0.05% + 0.08 × f%) of reading + 40 μA) (1 kHz < f ≤ 40 kHz) ±((0.2% × f%) of reading + 40 μA) (40 kHz < f ≤ 100 kHz) Accuracy values at frequencies over 1 kHz are provided as reference values. (Unit of f: kHz)
Reference conditions	23 ±5°C, 30 to 70% RH, AC input as sinewave Primary current: 2 to 1000 A, Common mode voltage: 0 V Supply voltage: rated supply voltage ±5%
Dimensions	751522: Approx. 426 (W) × 221 (H) × 401 (D) mm 751524: Approx. 426 (W) × 355 (H) × 401 (D) mm Note: The dimensions shown exclude projections such as input terminals and base feet.
Weight	751522: Approx. 15 kg, 751524: Approx. 28 kg
Consumed power	751522: Approx. 30 VA, 751524: Approx. 90 VA

PC-Based Control and Data Acquisition

Ideal for multichannel power measurements

The WTVIEWER E allows users to:

- Connect, synchronize and configure up to four WT units via Ethernet, USB, GPIB or RS232
- Remotely monitor, collect, and analyze live or stored multichannel measurements in a numeric, bar, trend, or vector formats
- Enables user defined computation such as efficiency with measured data from multiple units
- Save/load configuration and measurement data

WTVIEWER E software enables PC connectivity for Yokogawa power analyzers such as the WT5000, WT3000E, WT1800E, WT500 and WT300E through Ethernet, USB, GPIB or RS232. This connectivity allows users to easily control, monitor, collect, analyze, and save measurements remotely.

To stream the waveform data to a PC, it is possible to make use of WTVIEWER E 761941. This can also be done by making use of dedicated communication commands for programming. (The data streaming function is not available in the free software of WTVIEWER Efree.)

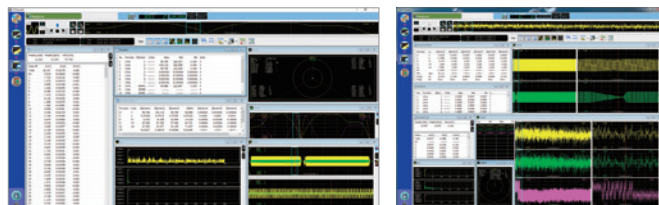
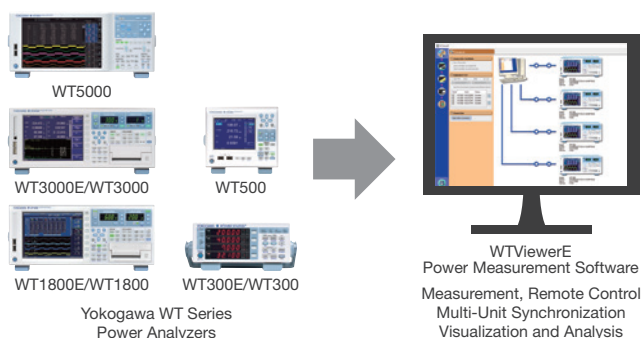

Display examples of WTVIEWER E

Specifications

Compatible WT series model and permissible combinations for multi unit connections

Series model	Number of permissible connections	Model	Firmware version
WT3000E/WT3000 series	Up to 4 units from all 8 models	WT3001E/WT3002E/WT3003E/WT3004E	No restriction
		WT3000 (760301/760302/760303/760304)*	6.11 or later
WT1800E/WT1800 series	Up to 4 units from all 12 models	WT1801E/WT1802E/WT1803E/WT1804E/WT1805E/WT1806E	No restriction
		WT1801/WT1802/WT1803/WT1804/WT1805/WT1806*	2.31 or later
WT500 series	Up to 4 units from all 3 models	WT500 (760201/760202/760203)	1.21 or later
WT300E/WT300 series	Up to 4 units from all 8 models	WT310E/WT310EH/WT332E/WT333E	No restriction
		WT310/WT310HC/WT332/WT333*	

*discontinued products

Functions

Measuring items	Normal, Harmonics, Integration
Display screens	Numeric, Waveform ^{1,4} , Trend, Harmonic list ² , Harmonic bar graph ² , Vector ^{2,3} and Analysis graph
Data acquisition interval	50 ms at maximum speed
Data conversion	Numeric and Waveform data: CSV format (.csv)

¹ Harmonic measurement option must be installed in the WT300 or WT300E.

² Harmonic measurement option must be installed in the WT.

³ A vector window cannot be displayed on the WT300 or WT300E.

⁴ When WT update interval is 1 second or longer and the WT waveform observation period is same as the update interval, measured waveform data can be acquired continuously. Continuous waveform data cannot be acquired from the WT300 or WT300E.

Model and Suffix Code

Model	Description
761941	WTVIEWER E

WT Series Accessory Software **Power Consumption Measurement Software (Free Software)**

Support for IEC62301 Standby Power Testing

- The IEC62301 Ed 2.0 is a reference standard in the EN 50564: 2011 Directive. This software corresponds to a test method of those two standards.
- Allows you to acquire the necessary data such as a power value with simple operations such as just pressing the Start button.
- Allows you to print out a report on the measurement results. (The free software can be downloaded from Yokogawa's website)

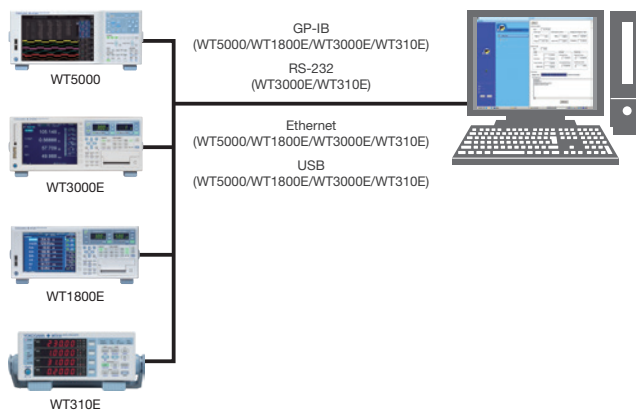
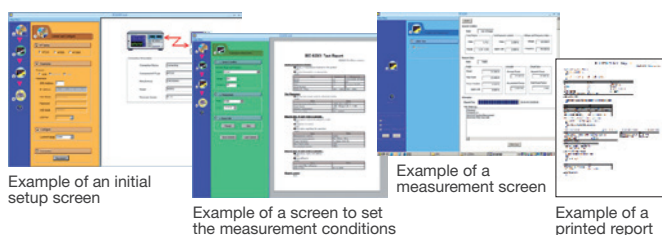

Support for IEC Standards Testing

- Allows you to judge high current equipment with input current of 16 A or more per phase (IEC61000-3-11/-3-12).
- Support for the method that does not consider interharmonics in the window of 16 cycles specified in IEC61000-4-7
- Best-in-class high-precision current and voltage measurements (also allows you to calculate the limits of the standard)
- All Judgment graph display shows a list of all the measurement results in a time series by order.
- Allows you to measure harmonics for up to 24 hours, so capable of measuring equipment that needs more than one hour for one cycle.
- Continuous data acquisition at a measurement interval of 200 ms ensures continuous measurement over a long period of time with no missing data
- Support for the standard tests of single- and three-phase equipment

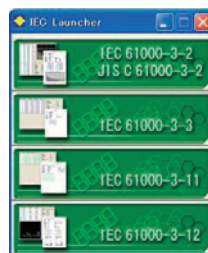

Launcher screen



Example of an initial setup screen

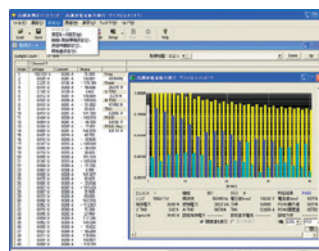

Example of a measurement screen

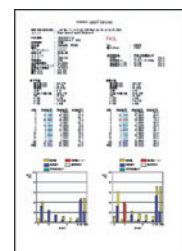

Example of a printed report

Model and Suffix Code

Model	Description
761922	Harmonic/Flicker Measurement software

Less than 20 A single phase

AC Power Supply
Reference Impedance Network

WT3000E Precision Power Analyzer
Recommended model: WT3001E-2A0-30A1-x/G6/FL

GP-IB or Ethernet

More than 20 A single phase

AC Power Supply
Reference Impedance Network

A special order model is available that includes a current transducer and shunt resistor set.

*You need to purchase the power supply and cable separately.

WT3000E Precision Power Analyzer
Recommended model: WT3003E-2A0-30A3-x/G6/FQ/FL

*The external sensor input of the WT3000E is used.

The FQ is required for Flicker test of three phase device.

*A special software model is prepared for making use of some specified power supplies and reference impedance network.

Current transducer power supply

Shunt resistor

GP-IB or Ethernet

IEC Harmonic and Flicker regulation test with WT5000 /G7 option is required for using the Integrated Software Platform IS8011/IS8012. For detail, please refer to P.44.

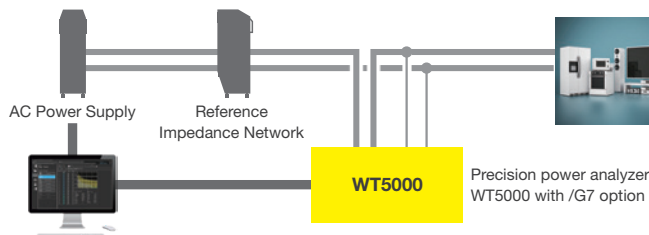

Digital Power Analyzers Accessories List

● : Compatible

Product Name	Model	Description	Image						
				WT5000	WT5000E	WT1800E	WT500	WT310E/WT330E	PX8000
1:1 BNC safety adapter lead	701901	1000 Vrms-CAT II, 1.8 m long Safety BNC (male) to safety banana (female) use in combination with 701959, 701954, 758921, 758922 or 758929		●	●	●	●	●	●
Measurement leads	758917	Two leads in a set. Use 758917 in combination with 758922 or 758929. Total length: 75 cm Rating: 1000 V, 32 A		●	●	●	●	●	●
Small alligator adapters	758922	For connection to measurement leads (758917). Two in a set. Rating: 300 V		●	●	●	●	●	●
Large alligator adapters	758929	For connection to measurement leads (758917). Two in a set. Rating: 1000 V		●	●	●	●	●	●
Safety terminal adapter set	758923	Spring-hold type. Two adapters in a set.		●	●	●	●	●	●
Safety terminal adapter set	758931	Screw-fastened adapters for voltage input. Two adapters in a set. 1.5 mm Allen wrench for tightening is required.		●	●	●	●	●	●
Safety terminal adapter set	761953	Screw-fastened adapters for current input of WT5000 and PX8000. Two adapters in a set. Allen wrench for tightening is required.		●					●
Safety terminal adapter set	761951	Screw-fastened adapters for large current input of WT5000. Two adapters in a set. Allen wrench for tightening is required.		●					
Fork terminal adapter	758921	Two adapters (red and black) to a set. Used when attaching banana plug to binding post.			●	●	●	●	
Conversion adapter	758924	For conversion between BNC and female banana plug		●	●	●	●	●	●
Conversion adapter	366971	9-pin/25-pin conversion adapter			●				
External sensor cable	B9284LK	For the external input of the WT series. Length: 50 cm		●	●	●	●	●	●
BNC cable	366924	BNC cable BNC-BNC, 1 m		●	●	●	●		
BNC cable	366925	BNC cable BNC-BNC, 2 m		●	●	●	●		
26 pin cable	705926	For/DA4 and/DA12 option						●	
Cable for current sensor element	761954/761955/ 761956	Dedicated cable for current sensor element, total length 3 m/5 m/10 m		●					
Current sensor cable	A1559WL	Cable length 3 m for CT60/CT200/CT1000				●			●
Current sensor cable	A1560WL	Cable length 5 m for CT60/CT200/CT1000				●			●
Current sensor direct cable	A1589WL	Cable length 3 m (Burden resistor 2.7 ohm) for CT60/CT200/CT1000				●			●
Current sensor direct cable	A1628WL	Cable length 5 m (Without Burden resistor) for CT60/CT200/CT2000A				●			●
Shunt resistor box	A1323EZ	5 Ω ±0.05% for CT1000				●			●
Shunt resistor box	A1324EZ	10 Ω ±0.02% for CT1000, Max. 640 A peak				●			●
Shunt resistor box	A1325EZ	20 Ω ±0.02% for CT200 and CT60				●			●
Rack mounting kit	751535-E4	For EIA			●	●			
Rack mounting kit	751535-J4	For JIS			●	●			
Rack mounting kit	751533-E2	For WT310E/WT310EH EIA standalone installation						●	
Rack mounting kit	751533-J2	For WT310E/WT310EH JIS standalone installation						●	
Rack mounting kit	751534-E2	For WT310E/WT310EH EIA connected installation						●	
Rack mounting kit	751534-J2	For WT310E/WT310EH JIS connected installation						●	
Rack mounting kit	751533-E3	For WT332E/WT333E EIA standalone installation						●	
Rack mounting kit	751533-J3	For WT332E/WT333E JIS standalone installation						●	
Rack mounting kit	751534-E3	For WT332E/WT333E EIA connected installation						●	
Rack mounting kit	751534-J3	For WT332E/WT333E JIS connected installation						●	
Rack mounting kit	751533-E4	For WT500 EIA standalone installation					●		
Rack mounting kit	751533-J4	For WT500 JIS standalone installation					●		
Rack mounting kit	751534-E4	For WT500 EIA connected installation					●		
Rack mounting kit	751534-J4	For WT500 JIS connected installation					●		
Rack mounting kit	751542-E4	For WT5000 EIA connected installation		●					
Rack mounting kit	751542-J4	For WT5000 JIS connected installation		●					

Accelerate Product Engineering Workflow

Integrated Software Platform

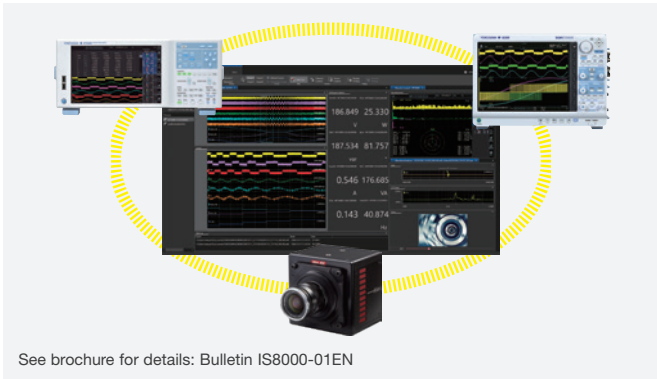

See brochure for details: Bulletin IS8000-01EN

The IS8000 software platform is an integrated solution that accelerates engineering workflow. It is a revolutionary platform that tightly integrates the timing, control, and data collection from multiple instruments, creating a comprehensive measurement suite that delivers confidence, efficiency, and unity.

Overview

High-Speed Waveform Data Streaming

In combination with the 10 Gb Ethernet interface option (C60 option) on the DL950 and the IS8000, up to eight channels of data can be stored in real time on a PC at a sampling rate of up to 20 M Sample/s.

Longer recording times are now possible for high-speed, multi-channel inputs such as gate signals and switching waveforms of multi-phase inverters.

In the absence of the C60 option, up to 16 channels of data can be stored in real time on a PC at a sampling rate of up to 200 k Sample/s.

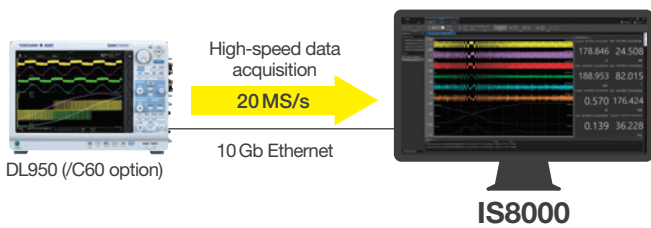

Multi-Unit Monitoring with Time Synchronization

SY1 option

Accurate power and waveform data synchronization is available across multiple channels with minimal error. Data from the WT5000 power analyzer and DL950 ScopeCorder is time-correlated with less than 10 μ s error using IEEE1588 PTP technology. Precise power parameters and waveforms are displayed on the same time axis.

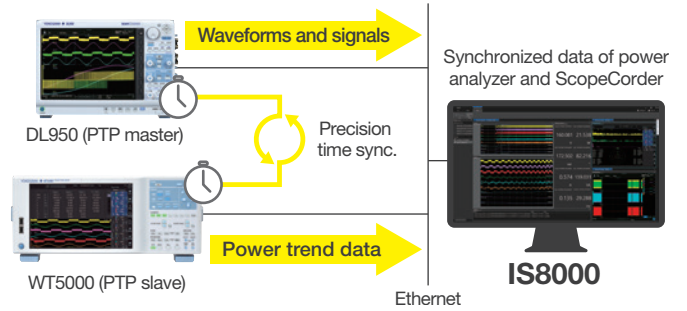

FFT and Math Function

MH1 option

Measure up to 16 Fast Fourier Transform (FFT) processes for a wealth of analysis functions for automatic calculation of frequency and integrated value and filter processing.

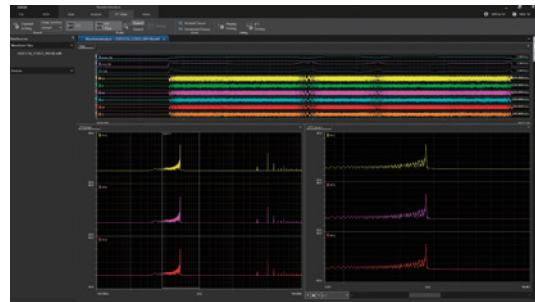

FFT Analysis window

Report Generator

RP1 option

Customized reports are easily created by dragging and dropping measurement data, waveforms, graphs, etc. onto the sheet.



Device control	Measurement	Analysis	Export
Device Settings Remote Monitoring	High-speed Acquisition	Enhanced Viewer	Export to CSV CSV
Application Control Interface	Power & Waveform Sync.	FFT Analysis Enhanced Math	Export to MDF MDF
Modbus/TCP Communication	High-Speed Cam. Sync.	Serial Bus Analysis	Report Generator
Connect to Multi units	ECU Monitor Sync.	IEC Harmonic/Flicker Test & Analysis IEC 61000	Standard functions of the software platform Add-on Functions Only available in IS8011/8012

Download the free 30-day trial <<https://tmi.yokogawa.com/p/is8000/>>



An Intuitive User Interface

- 1 Ribbon menu**
Format depends on which window is active.
- 2 Numeric display**
Numerical data from the WT5000 power analyzer can be displayed here.
- 3 Trend and waveform window**
Acquired data from single or multiple devices is displayed simultaneously.
- 4 Zoom/Pan window**
Up to four zoom regions can be defined and displayed simultaneously.
- 5 Remote control interface**
It works with the WT5000, DL350/850/950 and DLM3000/5000 series.
- 6 Recording file list**
Name, creation date and file size of the acquired data files are displayed here.
- 7 FFT Analysis (MH1 option required)**
Measure up to 16 FFT processes at the same time.
- 8 High-speed camera images (FS1 option required)**
IS8000 can synchronize high-speed video with acquired waveforms.

*This image has been partially processed.

Synchronize ECU Monitor

This option synchronizes the ECU data monitoring tool with the DL950 to enable synchronous measurement of the internal RAM values of the ECU and analog data such as rotation angle and speed of the motor.

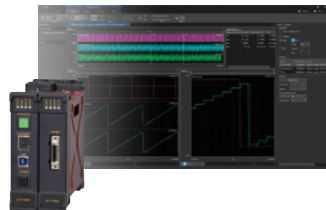

EM1 option

Synchronize High-Speed Camera

IS8000 synchronizes high speed camera images with related current, voltage, and control signals. Simultaneous slow motion playback allows visualization between design and results.



FS1 option

CAN Bus Analysis

With this option, users can decode CAN bus communication content, show the frame display, and search for specific information in the communication signal waveforms acquired by oscilloscopes, ScopeCorders, and IS8000.



SB1 option

Connect Recorders via Modbus/TCP

This option enables IS8000 to connect to and control measuring instruments such as Yokogawa SmartDAQ+ and collect data via Modbus/TCP communication. Other data recorders can also be connected to IS8000 by creating a configuration file using the included configuration tool.

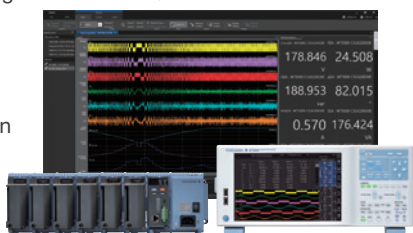

MB1 option

Model and Suffix Code

IS8000 Integrated Software Platform

Model	Suffix Code	Description
IS8001		IS8000 Integrated Software Platform Subscription (Annual license)
IS8002		IS8000 Integrated Software Platform Perpetual (Permanent license)
	/SY1	Multi-Unit Connection Option
	/MH1	Waveform Math Option
	/RP1	Report Generator Option
	/FS1	High-speed Camera Synchronization Option
	/EM1	ECU Monitor Synchronization Option
	/SB1	Serial Bus Analysis Option
	/MB1	Modbus/TCP Communication Option

Add-on Packages

Model	Suffix Code	Description
IS8001EX		IS8000 Add-on Package Subscription (Annual license)
IS8002EX		IS8000 Add-on Package Perpetual (Permanent license)
	-SY1	Multi-Unit Connection
	-MH1	Waveform Math
	-RP1	Report Generator
	-FS1	High-speed Camera Synchronization
	-EM1	ECU Monitor Synchronization
	-SB1	Serial Bus Analysis
	-MB1	Modbus/TCP Communication

Optional Software Package for IEC Harmonic and Flicker Compliance Test

The IS8011/IS8012 optional software package is designed to perform harmonic and flicker tests in accordance with IEC 61000-3-2, 3-3, 3-11 and 3-12 standards using the WT5000 precision power analyzer. Users can easily set the conditions and output the test report with no expertise needed.

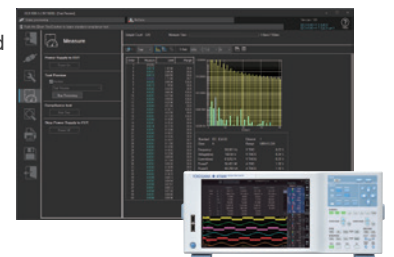

IS8010 IEC Harmonic/Flicker Measurement Software

Model	Suffix Code	Description
IS8011		IEC Harmonic/Flicker Software Subscription (Annual license)
IS8012		IEC Harmonic/Flicker Software Perpetual (Permanent license)

Higher Accuracy – The New Advanced DC Voltage/Current Source

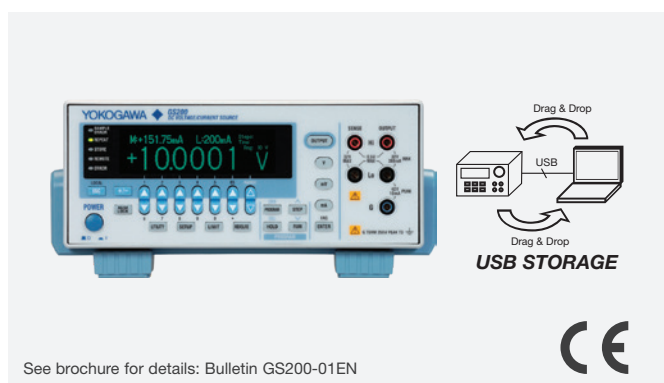

Functions

The GS200 generates high accuracy, high stability, high resolution, and extremely low-noise DC voltage and current signals that are required for many applications.

- Voltage source up to ± 32 V and current source up to ± 200 mA
- 5 1/2-digit, ± 120000 -count output resolution
- Voltage and current simple monitoring feature (optional)
- Programmable output up to 10000 points
- Built-in USB mass storage device
- Channel expansion through synchronous operation

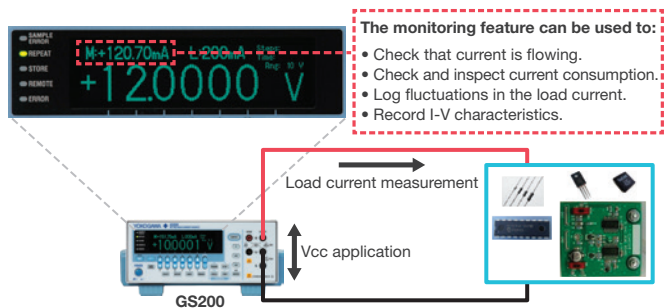

Voltage and Current Source Range

The GS200 can perform four-quadrant operation by operating as a current source or a current sink in the range of ± 30 V and ± 200 mA. When the GS200 is sinking current, it can operate over the exact same range as when it is operating as a current source. You can use the GS200 not just as a highly accurate voltage source but also as a highly accurate constant-current electronic load.

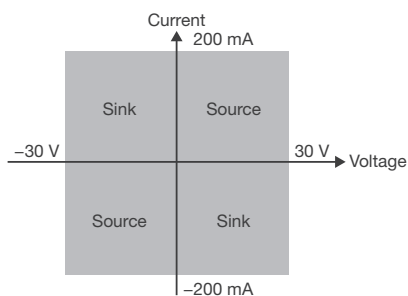

Specifications

Source		
Voltage source	Range	10 mV, 100 mV, 1 V, 10 V, 30 V (Use a highly accurate voltage divider at 10 mV and 100 mV ranges)
	Maximum output	± 200 mA (at 1 V, 10 V, and 30 V ranges)
Current source	Range	1 mA, 10 mA, 100 mA, 200 mA
	Maximum output	± 30 V
Program Feature	Maximum number of steps	10000
	Trigger source	Internal timer (0.1 s resolution), External, Step input, measurement end

Monitoring (option)	
Function	Voltage (during current generation) Current (during voltage generation)
Integration time	1 to 25 PLC (Power Line Cycle)
Trigger source	Internal timer (0.1 s resolution), READY, Communication and Immediate
Delay	0 to 999999 ms (1 ms resolution)
Maximum storage	10000 points

External Input and Output	
Input signal	TRIG IN, OUTPUT IN
Output signal	TRIG OUT, OUTPUT OUT, READY OUT
Connector	RJ-11 connector BNC connector (Select any one of the signals for both the input and output)
Input and output level	TTL
Minimum pulse width	10 μ s

Interface	
GP-IB interface, USB interface	
Ethernet interface (option)	100BASE-TX/10BASE-T

General Specifications	
Display	256 \times 64 dot vacuum fluorescent display
External dimensions	Approx. 213 (W) \times 88 (H) \times 350 (D) mm (excluding protrusions)
Weight	Approx. 5 kg

Model and Suffix Code

Model	Suffix Code	Description
GS210		DC voltage/current source (front panel output terminals)
GS211		DC voltage/current source (rear panel output terminals)
Supply voltage	-1	100 VAC, 50/60 Hz
	-4	120 VAC, 50/60 Hz
	-7	230 VAC, 50/60 Hz
Power cord	-D	UL/CSA standard and PSE compliant
	-F	VDE/Korean standard
	-R	Australian standard
	-Q	British standard
	-H	Chinese standard
	-N	Brazilian standard
	-T	Taiwanese standard
	-B	Indian standard
-U	IEC Plug Type B	
Options	/MON	Monitoring function
	/C10	Ethernet interface function

Highly Accurate 2-Channel Voltage/Current Source Measure Unit

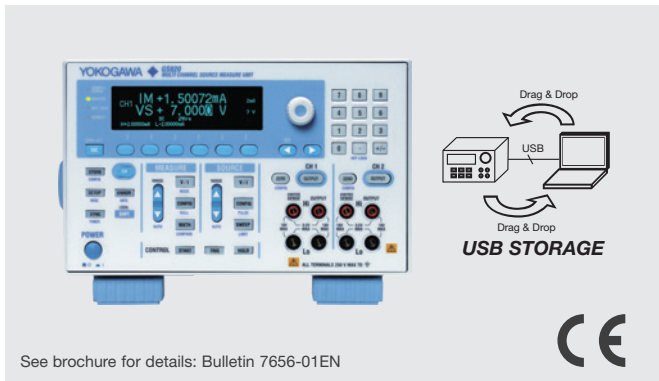

See brochure for details: Bulletin 7656-01EN

Features

The GS820 is a highly accurate and highly functional 2-channel programmable DC voltage/current source that incorporates voltage/current generation and measurement functions.

- Isolated 2-channel source and measurement function
- Basic accuracy: $\pm 0.02\%$ (DC voltage source)
- 1 pA resolution at extremely small current range 200 nA
- Generate arbitrary waveforms consisting of up to 100000 points at 100- μ s intervals
- Channel expansion through master-slave synchronization link
- Fast test speeds
- 16-bit digital I/O (model 765602/765612)

Source and Measurement Range

Four-quadrant operation consisting of source operation (current source) and sink operation (current sink) is available. The output and measurement resolutions are 5.5 digits. Two models are available for your application.

18 V range model (765601/02)

Voltage ranges	200 mV/2 V/7 V/18 V
Maximum output	± 3.2 A (at an output voltage of ± 7 V or less) ± 1.2 A (at an output voltage of ± 18 V or less)
Current ranges	200 nA/2 μ A/20 μ A/200 μ A/ 2 mA/20 mA/200 mA/1 A/3 A
Maximum output	± 18 V (at an output current of ± 1.2 A or less) ± 7 V (at an output current of ± 3.2 A or less)

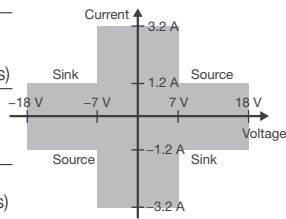

50 V range model (765611/12)

Voltage ranges	200 mV/2 V/20 V/50 V
Maximum output	± 1.2 A (at an output voltage of ± 20 V or less) ± 0.6 A (at an output voltage of ± 50 V or less)
Current ranges	200 nA/2 μ A/20 μ A/200 μ A/2 mA/20 mA/200 mA/0.5 A/1 A
Maximum output	± 50 V (at an output current of ± 0.6 A or less) ± 20 V (at an output current of ± 1.2 A or less)

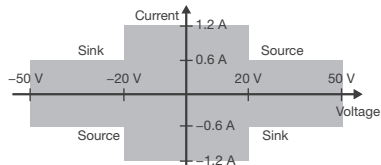

Specifications

Source and Measurement Functions

- Voltage source and current measurement (VS&IM)
- Current source and voltage measurement (IS&VM)
- Voltage source (VS)
- Current source (IS)
- Voltmeter (VM)
- Ammeter (IM)
- Resistance meter (IS&VM)

Source

Function	Voltage or current
Mode	DC or pulse (pulse width: 50 μ s to 3600 s)
Sweep mode	Linear, logarithmic or program (up to 100000 steps)
Trigger source	External or internal timers 1 and 2 (period: 100 μ s to 3600 s)
Sweep start source	External or internal timers 1 and 2 (period: 100 μ s to 3600 s)
Source delay	15 μ s to 3600 s
Response characteristics	Normal or stable

Measurement

Function	Voltage, current, auto, voltmeter mode, ammeter mode or resistance meter mode
Integration time	0.001 to 25 PLC (Power Line Cycle)
Trigger source	External or internal timers 1 and 2 (period: 100 μ s to 3600 s)
Measure delay	0 μ s to 3600 s
Measurement data storage	Up to 100000 data points
Average	Moving average (average count: 2 to 256)
Voltage sense	Two-wire system or four-wire system
Auto zero	Measure the internal zero reference every measurement and correct the measured value
NULL computation	Computes the difference with respect to the current measured value or user-defined value
User-defined computation	Computes user-defined equations in real-time

External I/O and Communication Interface

External I/O	BNC I/O
Digital I/O	D-Sub 15-pin (model 765601/11) Half-pitch 50-pin (model 765602/12)
I/O for synchronized Operation	RJ-11 connector 6-pin, BNC connector
Communication Interface	GPIB, RS232, USB, Ethernet: 100 BASE-TX/10 BASE-T

General Specifications

Display	256 x 64 dot VFD
Dimensions	Approx. 213 (W) x 132 (H) x 450 (D) mm
Weight	Approx. 8 kg

Model and Suffix Code

Model	Suffix Code	Description
765601		GS820 Multi Channel Source Measure Unit 18 V range/2-bit digital I/O model
765602		GS820 Multi Channel Source Measure Unit 18 V range/16-bit digital I/O model
765611		GS820 Multi Channel Source Measure Unit 50 V range/2-bit digital I/O model
765612		GS820 Multi Channel Source Measure Unit 50 V range/16-bit digital I/O model
Power cord	-D	UL/CSA standard, and PSE compliant
	-F	VDE/Korean standard
	-R	Australian standard
	-Q	British standard
	-H	Chinese standard
	-N	Brazilian standard
	-T	Taiwanese standard
	-B	Indian standard
	-U	IEC Plug Type B

Combines High Accuracy and High Speed in a Single Unit

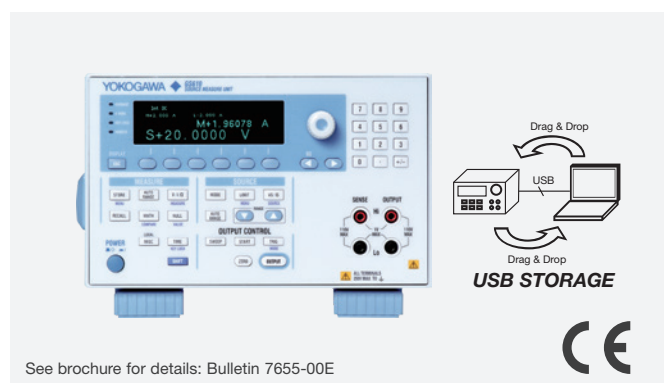

See brochure for details: Bulletin 7655-00E

Features

The GS610 is a highly accurate and highly functional programmable voltage/current source that incorporates voltage/current generation and measurement functions. The maximum output voltage and current are 110 V and 3.2 A, respectively. Evaluation of over a wide range of basic electrical characteristics is possible, because the GS610 can operate as a current source or a current sink.

- Source and sink operation up to 110 V/3.2 A (four-quadrant operation)
- Basic accuracy: $\pm 0.02\%$ * *DC voltage generation
- Sweep output at up to 100 μs intervals
- Comes with abundant sweep patterns (linear, logarithmic, and arbitrary)
- Stores up to 65535 points of source measure data in the internal memory
- Easy file operation with the USB storage function
- Remote control and FTP using Web server function (Optional)

Voltage/Current Generation and Measurement Range

Four-dimensional operation with source operation (current source) and sink operation (current sink) is possible at up to 110 V, 3.2 A, and 60 W.

The output and measurement resolutions are 5.5 digits.

- Voltage generation/measurement range: 200 mV to 110 V
- Current generation/measurement range: 20 μA to 3.2 A
- Maximum output current:
 - ± 3.2 A (at an output voltage of ± 12 V or less)
 - ± 2 A (at an output voltage of ± 30 V or less)
 - ± 1 A (at an output voltage of ± 60 V or less)
 - ± 0.5 A (at an output voltage of ± 110 V or less)

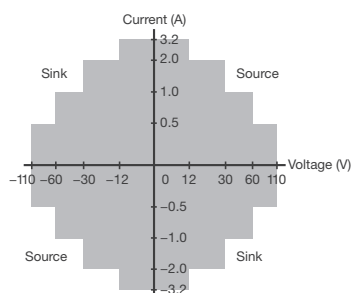

Specifications

Function		
Generation	Generation function	Voltage or current
	Generation mode	DC or pulse
	Sweep mode	Linear, logarithmic or program (up to 65535 steps)
Measurement	Measurement function	DC voltage, DC current and resistance
	Measurement data storage	Up to 65535 data points
	Average	Block average or moving average (Specified count: 2 to 256)
Trigger	Trigger mode	Internal, external and immediate
Time setting	Pulse width	100 μs to 3600 s, 1 μs resolution
	Period time	1 ms to 3600 s, 1 μs resolution (during source and measure operation) 100 μs to 3600 s, 1 μs resolution (during source-only operation)
	Source delay	1 μs to 3600 s, 1 μs resolution
	Measurement delay	1 μs to 3600 s, 1 μs resolution
	Integration time	250 μs , 1 ms, 4 ms, 16.6 ms/20 ms, 100 ms, 200 ms (auto detect from the power supply frequency when the power is turned ON for 16.6 ms/20 ms)
Computation function	Operators	+ [addition], - [subtraction], * [multiplication], / [division] and ^ [exponentiation]
	Functions	ABS(), EXP(), LN(), LOG(), SQRT(), SIN(), COS(), TAN(), ASIN(), ACOS(), ATAN(), SINH(), COSH(), TANH(), RAND()

External Input/Output

- Synchronization signal input/output (TRIG, SWEEP, CTRL IN and OUT) (BNC)
- External input/output (D-Sub 15-pin)
- GP-IB interface
- RS-232 interface
- USB interface
- Ethernet interface (option) 100BASE-TX/10BASE-T

General Specifications

Internal memory	ROM	4 MB Area for storing setup and output pattern files
	RAM	4 MB Area for storing the measured results (cleared when the power is turned OFF)
Display	256 \times 64 dot vacuum fluorescent display	
External dimensions	Approx. 213 (W) \times 132 (H) \times 400 (D) mm (excluding protrusions)	
Weight	Approx. 7 kg	

Model and Suffix Code

Model	Suffix Code	Description
765501		GS610 Source Measure Unit
Power cord	-D	UL/CSA standard and PSE compliant
	-F	VDE/Korean standard
	-R	Australian standard
	-Q	British standard
	-H	Chinese standard
	-N	Brazilian standard
	-T	Taiwanese standard
	-B	Indian standard
	-U	IEC Plug Type B
Option	/C10	Ethernet interface

The Perfect Tool for DC Parametric Testing from Small Signals to ±110 V

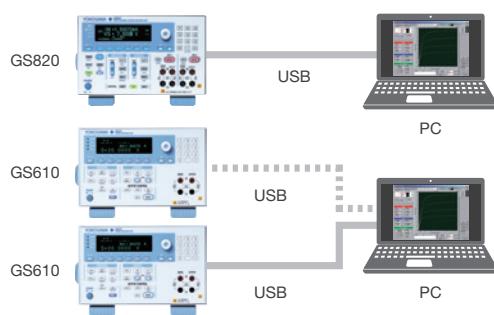
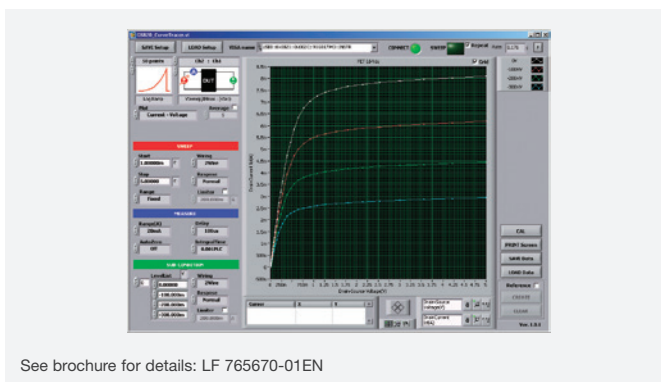

System configuration illustration

Overview

This product is a high-speed, high-accuracy real-time I-V curve tracer that consists of the GS series Source Measure Unit and the 765670 Curve Tracer Software. It is particularly well-suited to DC parametric tests of minute signals.

Features

Simple system configuration, easy connection, compact and light

This system is configured by connecting the GS series Source Measure Unit to a PC that contains the 765670 Curve Tracer Software via USB. You can perform high speed, high-accuracy curve tracing despite its compact size, light weight, and simple system configuration.

Real-time, High-Speed Drawing

The GS series is high-speed communication and sweep features allow high-speed graph update rate up to 25 pages/s (GS820). You can use the real-time curve tracer with comfort.

Field of Applications

- Discrete semiconductors such as transistors and diodes
- Analog ICs such as voltage regulators and op- amps
- MOS logic and other digital ICs
- LEDs and other optical devices
- Solar battery cells

Drawing Speed (times/s; reference values)

Plot Points	Model Number	
	GS610	GS820
20	20	25
50	10	16
100	5	11
200	3	6

Measurement conditions:
Using Core2Duo CPU, 1.5 GHz, USB 2.0, and LabVIEW
Measurement integration time:
0.001 PLC for GS820/250 µs for GS610

Specifications

- Graph drawing Voltage vs. current, voltage vs. voltage, gain vs. voltage, voltage vs. timestamp, current vs. voltage, current vs. current, gain vs. current, current vs. timestamp
- Sweep axis: Voltage source or current source
 - Measurement axis: Voltage measurement or current measurement
 - Parameter: Voltage source or current source
 - Sweep shape: Ramp (linear or log), triangle (linear or log), rectangle
 - Sweep points: 5, 10, 20, 50, 100, 200, 1000
 - Scaling: Auto scale or fixed scale
 - Averaging count: 2 to 100

- Analysis feature Cursor, zoom & scroll, reference curve designation
- File operations CSV data storage and loading, graphic image storage, panel image storage, setup storage and recall

Examples of Measurements of Characteristics

(FET V_{DS} - I_D characteristics)

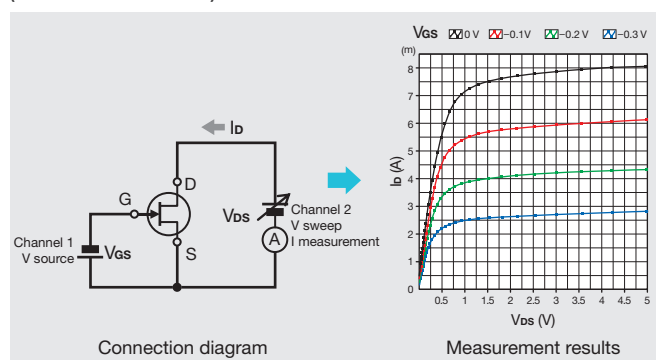

Model and Suffix Code

Model	Suffix Code	Description
765670	-E	Curve Tracer Software English Version 1 license
765501		GS610 Source Measure Unit Standard Model
765601		GS820 Multi Channel Source Measure Unit, 18 V range/2-bit digital I/O model
765602		GS820 Multi Channel Source Measure Unit, 18 V range/16-bit digital I/O model
765611		GS820 Multi Channel Source Measure Unit, 50 V range/2-bit digital I/O model
765612		GS820 Multi Channel Source Measure Unit, 50 V range/16-bit digital I/O model

AC Power Calibrator for Highly Accurate, Stable, and Wide Range Output



See brochure for details: Bulletin LS3300-01EN

Features

The LS3300 is a single-phase AC power calibrator that can generate highly accurate, stable, and wide range output current and voltage. A single LS3300 unit supports 1P2W, and multiple LS3300 units support 1P3W, 3P3W and 3P4W. It can support AC voltage/current, active/reactive power, power factor and phase angle. It can calibrate Power meter of 0.15% class, Clamp-on power meter, AC clamp-on tester and Power monitor.

- High accuracy (At 1 year) AC voltage: ± 350 ppm ($\pm 0.035\%$)
AC current: ± 450 ppm ($\pm 0.045\%$)
AC power: ± 450 ppm ($\pm 0.045\%$)
- High stability AC voltage, current: ± 50 ppm/h ($\pm 0.005\%/h$)
AC power: ± 100 ppm/h ($\pm 0.01\%/h$)
- Phase accuracy: $\pm 0.03^\circ$ at 50/60 Hz
- Wide generation range AC voltage: 10 mV to 1250 V
AC current: 0.3 mA to 62.5 A
- Large current output up to 180 A
- The calibration by AUX output

The power meter calibration software supports the automated calibration for the WT series power meters (Free of charge). It is possible to shorten the calibration time.

*For details, please refer to the power meter calibration software on page 52.

Specifications

AC Voltage

Range	Output Range*	Resolution
1 V	0 to 1.25000 V	10 μ V
10 V	0 to 12.5000 V	100 μ V
30 V	0 to 37.5000 V	100 μ V
100 V	0 to 125.000 V	1 mV
300 V	0 to 375.000 V	1 mV
1000 V	0 to 1250.00 V	10 mV

AC Current

Range	Output Range*	Resolution
30 mA	0 to 37.5000 mA	0.1 μ A
100 mA	0 to 125.000 mA	1 μ A
1 A	0 to 1.25000 A	10 μ A
10 A	0 to 12.5000 A	100 μ A
50 A	0 to 62.500 A	1 mA

AUX

Range	Output Range*	Resolution
500 mV	0 to 625.00 mV	10 μ V
5 V	0 to 6.2500 V	100 μ V

*The output level can be set up to 120% of the range.
For outputs exceeding 120%, the ratio must be set to 100% or higher.

Settings

Item	Setting Value	
Voltage	Range	1 V, 10 V, 30 V, 100 V, 300 V, 1000 V
	Level	0 to 120% (of range)
	Level Ratio	0 to 120% (of setting)
	Phase Angle	-180° to $+359.999^\circ$
Current	Range	30 mA, 100 mA, 1 A, 10 A, 50 A, 100 A, 150 A, AUX Output 500 mV, 5 V
	Level	0 to 120% (of range)
	Level Ratio	0 to 120% (of setting)
	Phase Angle	-180° to $+359.999^\circ$
Power Factor	LEAD/LAG -1 to 0 to $+1$	
Frequency	40 Hz to 1.2 kHz	
Wiring	kind of wiring	1P2W, 1P2W (Hi Current), 1P3W, 3P3W, 3P3W (3V3A), 3P4W
	Oscillator	INTernal 40 Hz to 1.2 kHz EXTernal Input from the external oscillator (I/Q) LINE 50/60 Hz
Sweep	Time	8 s, 16 s, 32 s, 64 s
	Range	0 to 100%, 0 to 105%, 0 to 110%, 0 to 120%
AUX	V/A Conversion Ratio	0.0001 mV/A to 99999.9999 mV/A
Ground/Ungrounded	Voltage and current (including AUX) can be switched separately.	
Distortion Rate	Voltage output	0.07% or smaller
	Current output	0.18% or smaller
	AUX output	0.10% or smaller
Response Time	Approx. 2 s, at $0 \rightarrow 100\%$ of the setting	

Output terminal	Type
Voltage	Plug-in terminal (Safety terminal)
Current	Binding post

General Specifications

Computer Interface	USB, GPIB, Ethernet
Warm-up time	Approx. 30 minutes
Operating environment	Temperature: 5°C to 40°C
	Humidity: 20% RH to 80% RH
Storage environment	Temperature: -15°C to 60°C
	Humidity: 20% RH to 80% RH
Rated supply voltage	100 VAC to 120 VAC, 200 VAC to 240 VAC
Rated supply frequency	50 Hz/60 Hz
Permitted power supply frequency range	48 Hz to 63 Hz
	Maximum power consumption
External dimensions	426 (W) \times 132 (H) \times 450 (D) mm
Weight	Approx. 20 kg

Model and Suffix Code

Model	Suffix Code	Description
LS3300		AC Power Calibrator
Power cord	-B	Indian Standard
	-D	UL/CSA standard, and PSE compliant
	-F	VDE/Korean standard
	-R	Australian standard
	-Q	British standard
	-H	Chinese standard
	-N	Brazilian standard
	-T	Taiwanese standard
	-U	IEC Plug Type B

High-Voltage, High-Current Output and Intuitive Operation



See brochure for details: Bulletin 2560A-01EN

Features

The 2560A can accurately and stably generate DC voltage of up to 1224 V and DC current of up to 36.72 A. In addition to voltage and current meters, the 2560A can calibrate thermometers and temperature controllers that use thermocouples and RTDs.

- **Wide output range** DC voltage: ± 1224 V
DC current: -12.24 A to $+36.72$ A
- **High accuracy** DC voltage: ± 50 ppm (0.005%)
DC current: ± 70 ppm (0.007%)
- **High stability** DC voltage: ± 10 ppm (0.001%)/h
DC current: ± 20 ppm (0.002%)/h
- **High resolution** 5.5 digits, ± 120000 count display
6.5 digits, ± 1200000 count display
- **Intuitive operability** with dials for each digit
- **Sweep, output division, deviation, scale setting**
- **Ten types of thermocouples, and RTD Pt100**
- **User-defined temperature calibration, three RJC modes**
- **The power meter calibration software supports the automated calibration for the WT series power meters (Free of charge). It is possible to shorten the calibration time.**

*For details, please refer to the power meter calibration software on page 52.

Specifications

Voltage and current generating parts

Range	Output range	Resolution
100 mV	± 122.400 mV	1 μ V
1 V	± 1.22400 V	10 μ V
10 V	± 12.2400 V	100 μ V
100 V	± 122.400 V	1 mV
1000 V	± 1224.00 V	10 mV
100 μ A	± 122.400 μ A	1 nA
1 mA	± 1.22400 mA	10 nA
10 mA	± 12.2400 mA	100 nA
100 mA	± 122.400 mA	1 μ A
1 A	± 1.22400 A	10 μ A
10 A	± 12.2400 A	100 μ A
30 A	0 to $+36.720$ A	1 mA

Range	Accuracy (1 year) \pm (ppm of setting + V or A)	Stability (1 h) \pm (ppm of setting + V or A)
100 mV	60 + 4 μ V	20 + 3 μ V
1 V	55 + 15 μ V	5 + 5 μ V
10 V	55 + 150 μ V	5 + 50 μ V
100 V	55 + 1.5 mV	5 + 500 μ V
1000 V	55 + 15 mV	5 + 5 mV
100 μ A	150 + 20 nA	50 + 5 nA
1 mA	70 + 30 nA	5 + 15 nA
10 mA	70 + 300 nA	5 + 150 nA
100 mA	90 + 3 μ A	10 + 1.5 μ A
1 A	350 + 70 μ A	25 + 25 μ A
10 A	380 + 1.2 mA	50 + 500 μ A
30 A	540 + 1.8 mA	70 + 1.2 mA

Temperature generation for thermocouples

Setting temperature: Accuracy for 1 year (\pm °C)

R	S	B	J	T
-50°C: 1.10	-50°C: 1.03	400°C: 1.00	-210°C: 0.25	-250°C: 0.72
0°C: 0.80	0°C: 0.75	600°C: 0.70	-100°C: 0.11	-200°C: 0.29
100°C: 0.55	100°C: 0.56	1000°C: 0.50	0°C: 0.08	-100°C: 0.16
600°C: 0.40	400°C: 0.47	1200°C: 0.44	1200°C: 0.15	100°C: 0.10
1600°C: 0.40	1600°C: 0.44	1820°C: 0.44		400°C: 0.09
1768°C: 0.45	1768°C: 0.51			

E	K	N	C	A
-250°C: 0.50	-250°C: 0.94	-240°C: 1.00	0°C: 0.30	0°C: 0.34
-200°C: 0.20	-200°C: 0.30	-200°C: 0.44	200°C: 0.26	100°C: 0.29
-100°C: 0.10	-100°C: 0.15	-100°C: 0.21	600°C: 0.25	600°C: 0.28
0°C: 0.07	0°C: 0.11	0°C: 0.16	1000°C: 0.30	1600°C: 0.47
1000°C: 0.12	800°C: 0.15	800°C: 0.15	2000°C: 0.51	2500°C: 0.79
	1300°C: 0.21	1300°C: 0.20	2315°C: 0.70	

3 RJC modes

INT: Uses a temperature measured at the output terminal as a compensation value.

EXT: Uses a temperature detected by a sensor connected to the RJ sensor terminal as a compensation value.

MAN: Uses a value input manually as a compensation value.

Temperature generation for RTDs

Type	Output range	Resolution	Accuracy (1 year)
Pt100	-200.0 to 850.0°C	0.1°C	± 0.12 °C

Resistance generation

Range	Output range	Resolution	Accuracy (1 year) \pm (ppm of setting + Ω)
400 Ω	1.00 to 400.00 Ω	0.01 Ω	75 + 0.005

General specification/Communication Interface

Interface	USB interface (PC connection), Ethernet, GP-IB
Warm-up time	Approx. 30 min
Operating environment	Temperature 5 to 40°C, Humidity 20 to 80%RH (no condensation)
Rated power supply voltage	100 to 120 V AC/200 to 240 V AC
Rated power supply frequency	50/60 Hz
Max. power consumption	Approx. 200 W A
Dimensions	426 (W) x 177 (H) x 400 (D) mm
Weight	Approx. 13 kg

Model and Suffix Code

Model	Suffix Code	Description
2560A		Precision DC Calibrator
	-VA	Version A
	-UC	Deg C
	-UF	Deg C and F
	-D	UL/CSA standard, and PSE compliant
	-F	VDE/Korean standard
	-R	Australian standard
	-Q	British standard
	-H	Chinese standard
	-N	Brazilian standard
	-T	Taiwanese standard
	-B	Indian standard
	-U	IEC Plug Type B

Automatically Calibrates a Power Meter (WT Series) Using Yokogawa's AC Power Calibrator LS3300 or Precision DC Calibrator 2560A!!

Generators, Sources, Manometers etc.

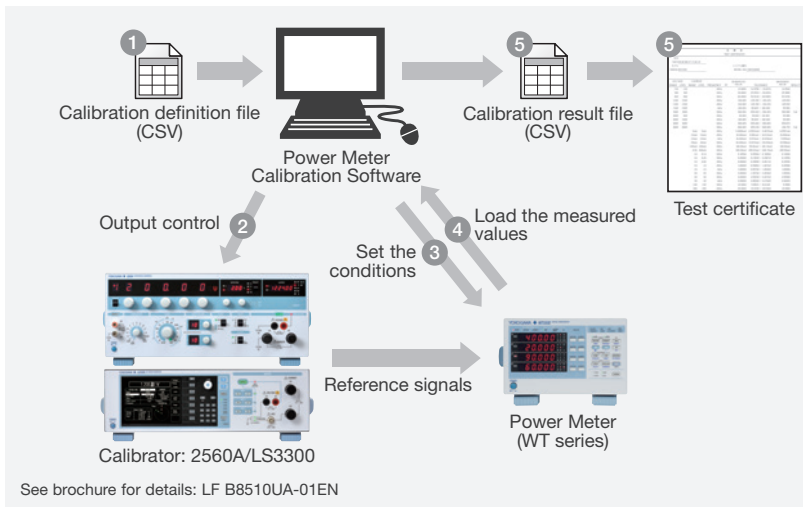

- 1 Load a CSV format calibration definition file describing calibration points.
- 2 Control the LS3300 or 2560A so that reference signals are output according to the calibration points.
- 3 Set the range of the calibration target instrument remotely.
- 4 Read the measured values automatically.
- 5 Create a measurement result file and report in CSV format.

How to download (free of charge)

Registered users can download the software free of charge from our HP.
<https://tmi.yokogawa.com/p/pmcs/>

Features

Shortening of calibration time

Example: Calibrating WT310E AC 52 points

Manual calibration **Approx. 20 min** → Calibration software **Approx. 2 min 40 s** **Reduced to 1/8 !**

Pass/fail judgment of a calibration value "Pass (Blank), Warning, Fail"

Generated val	Measured value	Tolerance	Error ratio	Result
15.000V	14.992V	14.970V ~ 15.030V	-26%	
30.000V	29.984V	29.940V ~ 30.060V	-26%	
60.000V	59.917V	59.880V ~ 60.120V	-69%	Warning
150.00V	149.91V	149.70V ~ 150.30V	-30%	
150.00V	149.90V	149.70V ~ 150.30V	-33%	

Calibration definition file

Sample files are provided for each WT series model. Calibration points can be created arbitrarily as a calibration definition file.

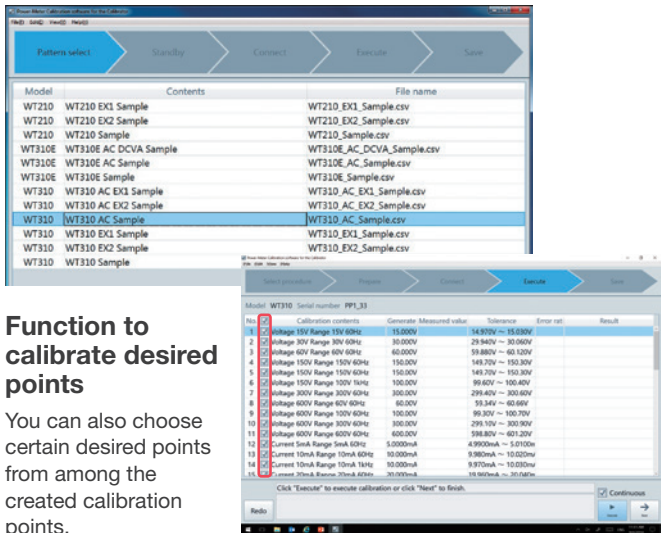

Function to calibrate desired points

You can also choose certain desired points from among the created calibration points.

Wizard function

For calibration patterns and instrument connection methods, operation instructions and wiring diagrams are shown on the screen.

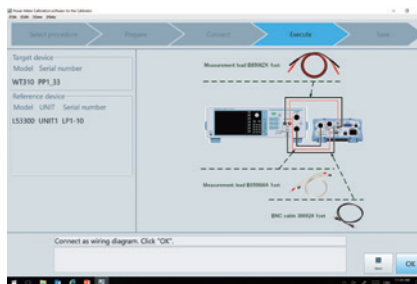

Specifications

Calibration Target Instruments	WT300E, WT300, WT200, WT100 series
Calibratable point	Output range of LS3300 (AC) and 2560A (DC)
Supported communication interface	USB, GP-IB, ETHRNET, RS-232

Instrument configuration

Up to 3 units of LS3300, up to 2 units of 2560A can be connected as reference calibrators. Power meter wiring systems are available from single-phase two-wire to three-phase four-wire.

Calibration Function		LS3300	2560A	
AC	Voltage	●	N/A	
		●	N/A	
	Current	60 A	● 2 units	N/A
		120 A	● 3 units	N/A
		180 A	● 60 A	N/A
		1P2W	● 120 A 2 units	N/A
Power	3P3W	● 180 A 3 units	N/A	
	3P4W	● 2 units	N/A	
	● 2 units	N/A	N/A	
	● 3 units	N/A	N/A	
DC	Voltage	N/A	●	
	Current	N/A	●	
	Power	N/A	● 2 units	

DC Calibrator for Temperature, Voltage, and Current

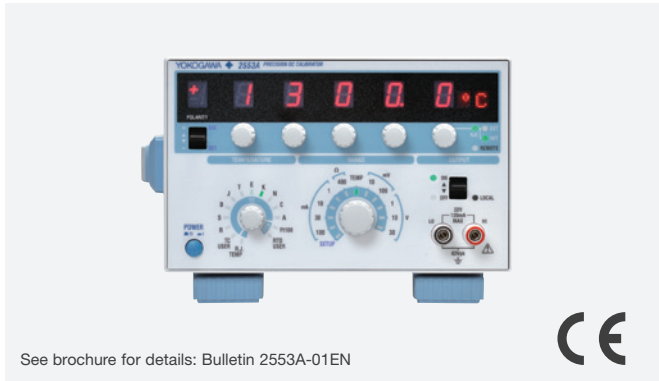

See brochure for details: Bulletin 2553A-01EN

Features

The 2553A outputs DC voltage in the range of ± 32 V and DC current in the range of ± 120 mA. In addition to being able to calibrate analog meters, the 2553A can calibrate thermometers and temperature controllers that utilize a thermocouple or RTD.

- High accuracy DC voltage: ± 75 ppm (0.0075%)
DC current: ± 120 ppm (0.012%)
- High stability: ± 15 ppm (0.0015%/h)
- Low noise: 2 μ Vrms
- High resolution: 5.5 digits
- Intuitive operation by dials
- 10 types of thermocouple and RTD Pt100
- User defined temperature calibration
- 3 RJC modes
- Calibration by temperature value

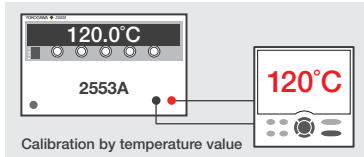

Specifications

Voltage, current generation

Range	Source range	Resolution
10 mV	± 12.0000 mV	100 nV
100 mV	± 120.000 mV	1 μ V
1 V	± 1.20000 V	10 μ V
10 V	± 12.0000 V	100 μ V
30 V	± 32.000 V	1 mV
1 mA	± 1.20000 mA	10 nA
10 mA	± 12.0000 mA	100 nA
30 mA	± 32.000 mA	1 μ A
100 mA	± 120.000 mA	1 μ A

Range	Accuracy (1 year) \pm (ppm of setting + μ V or μ A)	Stability (1 hour) \pm (ppm of setting + μ V or μ A)
10 mV	60 + 4	20 + 3
100 mV	60 + 4	20 + 3
1 V	60 + 15	5 + 10
10 V	60 + 150	5 + 100
30 V	60 + 450	5 + 300
1 mA	80 + 0.04	5 + 0.015
10 mA	100 + 0.5	5 + 0.15
30 mA	100 + 1.5	10 + 0.9
100 mA	100 + 5	10 + 3

Temperature generation for Thermocouple

Setting temperature: Accuracy for 1 year (\pm °C)

R	S	B	J	T
-50°C: 1.10	-50°C: 1.03	400°C: 1.00	-210°C: 0.25	-250°C: 0.72
0°C: 0.80	0°C: 0.75	600°C: 0.70	-100°C: 0.11	-200°C: 0.29
100°C: 0.55	100°C: 0.56	1000°C: 0.50	0°C: 0.08	-100°C: 0.16
600°C: 0.40	400°C: 0.47	1200°C: 0.44	1200°C: 0.15	100°C: 0.10
1600°C: 0.40	1600°C: 0.44	1820°C: 0.44		400°C: 0.09
1768°C: 0.45	1768°C: 0.51			

E	K	N	C	A
-250°C: 0.50	-250°C: 0.94	-240°C: 1.00	0°C: 0.30	0°C: 0.34
-200°C: 0.20	-200°C: 0.30	-200°C: 0.44	200°C: 0.26	100°C: 0.29
-100°C: 0.10	-100°C: 0.15	-100°C: 0.21	600°C: 0.25	600°C: 0.28
0°C: 0.07	0°C: 0.11	0°C: 0.16	1000°C: 0.30	1600°C: 0.47
1000°C: 0.12	800°C: 0.15	800°C: 0.15	2000°C: 0.51	2500°C: 0.79
	1300°C: 0.21	1300°C: 0.20	2315°C: 0.70	

3 RJC modes INT: Detect temperature of output terminal as compensation value
EXT: Detect compensation value by sensor connected to RJC terminal
MAN: Input compensation value

Temperature generation for RTD

Type	Source range	Resolution	Accuracy (1 year)
Pt100	-200.0 to 850.0°C	0.1°C	± 0.15 °C

Resistance generation

Range	Source range	Resolution	Accuracy (1 year) \pm (ppm of setting + Ω)
400 Ω	18.00 to 400.00 Ω	0.01 Ω	75 + 0.015

General specification/Communication Interface

Interface	USB, Ethernet, GPIB
Warm-up time	Approx. 30 minutes
Operating environment	Temperature 5 to 40°C, Humidity 20 to 80% RH
Storage environment	Temperature -15 to 60°C, Humidity 20 to 80% RH
Operating Height	2000 m or less
Operating Attitude	Horizon
Rated power supply voltage	100 to 120 VAC/200 to 240 VAC
Allowable power supply voltage fluctuation range	90 to 132 VAC/180 to 264 VAC
Rated power supply frequency	50/60 Hz
Allowable power supply frequency fluctuation range	48 to 63 Hz
Max. power consumption	30 VA
Withstand voltage	Between power and case 1500 VAC 1 min.
Dimensions	213 (W) \times 132 (H) \times 300 (D) mm
Weight	Approx. 3 kg

Model and Suffix Code

Model	Suffix Code	Description
2553A		Precision DC Calibrator
	-VA	Version A
	-UC	Deg C
	-UF	Deg C and F
	-D	UL/CSA standard, and PSE compliant
	-F	VDE/Korean standard
	-R	Australian standard
	-Q	British standard
	-H	Chinese standard
	-N	Brazilian standard
	-T	Taiwanese standard
	-B	Indian standard
	-U	IEC Plug Type B

AC Standard Source with Improved Performance and Usability

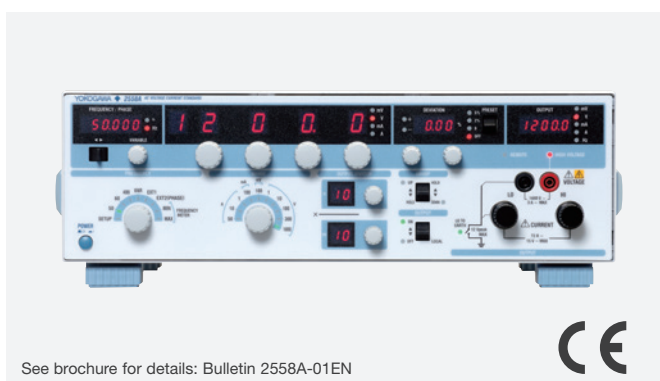

See brochure for details: Bulletin 2558A-01EN

Features

The wide output ranges of 1.00 mV to 1200.0 V AC and 1.00 mA to 60.00 A AC mean that the 2558A is the instrument of choice for the cost effective calibration of AC analog meters.

- Wide output range AC voltage: 1.00 mV to 1200.0 V
AC current: 1.00 mA to 60.00 A
- High accuracy AC voltage: 0.04%
AC current: 0.05%
- High output stability: ± 50 ppm/h
- Wide frequency range: 40 to 1000 Hz (Accuracy: ± 50 ppm)
- Intuitive operation with dials for setting each digit
- Sweep function: 8/16/32/64 s (selectable)
- Output divider function (Divided output of the main setting)
- Direct readout of the deviation (Displays the deviation from the main setting)

Specifications

Output

Range	Output Range	Guaranteed Accuracy Range
100 mV	0 to 144.00 mV	1 to 120.00 mV
1 V	0 to 1.4400 V	0.01 to 1.2000 V
10 V	0 to 14.400 V	0.1 to 12.000 V
100 V	0 to 144.00 V	1 to 120.00 V
300 V	0 to 432.0 V	3 to 360.0 V
1000 V	0 to 1440.0 V	10 to 1200.0 V
100 mA	0 to 144.00 mA	1 to 120.00 mA
1 A	0 to 1.4400 A	0.01 to 1.2000 A
10 A	0 to 14.400 A	0.1 to 12.000 A
50 A	0 to 72.00 A	0.5 to 60.00 A

Accuracy (180 days)

		1 to 10% output of range \pm (% of range)	10 to 120% output of range \pm (% of setting + % of range)
Voltage	50/60 Hz	0.013	0.03 + 0.01
	40 to 400 Hz	0.015	0.05 + 0.01
	400 to 1000 Hz	0.030	0.10 + 0.02
Current	50/60 Hz	0.014	0.04 + 0.01
	40 to 400 Hz	0.016	0.06 + 0.01
	400 to 1000 Hz	0.032	0.12 + 0.02

Output Characteristic

Stability		\pm (20 ppm of setting + 30 ppm of range)/h
Distortion factor	Voltage	0.07% or less
	Current	0.18% or less
Frequency range	Internal	50/60/400 Hz/VAR VAR: 40 to 1000 Hz (0.001 Hz resolution)
	External	EXT1/EXT2 (Use the terminals for synchronized operations)
FREQUENCY METER		
MIN/MAX		
20 to 1000 Hz (0.001 Hz resolution)		
Sweep, output divider and deviation functions are used for the frequency.		
Sweep	Target	Voltage/Current/Frequency
	Speed	Approx. 8/16/32/64 s selectable
Output divider	Target	Voltage/Current/Frequency
	Denominator range	m4 to 15
	Numerator range	n0 to 15 ($n \leq m$)
Deviation	Target	Voltage/Current/Frequency Variable range: $\pm 20.00\%$
	Operation	Two dials
		Resolution of the first dial: 0.2% of the main setting Resolution of the second dial: 0.01% of the main setting
Deviation preset		
OFF/0/2%/5%		
Output terminal	Type	Voltage: Plug-in terminal (safety terminal)
		Current: Binding post Selectable LO terminal to earth or floating Max. floating voltage to earth: 12 Vpk

General specification/Communication Interface

Interface	USB interface (for PC connection), Ethernet, GP-IB interface (optional)
Warm-up time	Approx. 30 minutes
Operating environment	Temperature 5 to 40°C
	Humidity 20 to 80%RH (no condensation)
Rated power supply voltage	100 to 120 VAC/200 to 240 VAC
Rated power supply frequency	50/60 Hz
Max. power consumption	200 VA
Weight	Approx. 20 kg
Dimensions	426 (W) \times 132 (H) \times 400 (D) mm

Model and Suffix Code

Model	Suffix Code	Description
2558A		AC Voltage Current Standard
Power cord	-D	UL/CSA standard, and PSE compliant
	-F	VDE/Korean standard
	-R	Australian standard
	-Q	British standard
	-H	Chinese standard
	-N	Brazilian standard
	-T	Taiwanese standard
	-B	Indian standard
	-U	IEC Plug Type B
Option	/C1	GP-IB interface

Bring New Value by the Multiple Display Formats and High Sampling Speed



See brochure for details: Bulletin DM7560-01EN

Features

The DM7560 provides high sampling rates of up to 30 kS/s with high accuracy and provides all the basic functions of a Digital Multimeter. With its capability to monitor transitional voltage variations, it can be applied to a wide range of applications.

- Multiple display formats
- High speed data logging (Maximum 30 kS/s)
- High capacity internal memory up to 100 k points
- Offline browsing to provide trend and histogram analysis
- Productivity improvement by varied interfaces

Comprehensive observation by multiple display formats

Annunciator
Indicates the status of the instrument status by icons.

Primary display (examples)

- Trend display (Plots time domain variation)
- Histogram display (Plots distribution)
- Arc scale meter display (Shows values intuitively)

Secondary display (examples)

- Analog meter display
- Statistics display
- LIMIT judgment display

High-speed data logging

The case of 10 ms pulse width, 2 Vpp measurement with DC voltage measuring function.

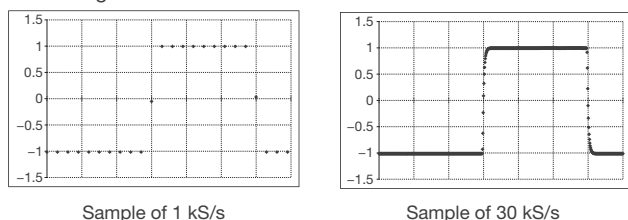

Fast signal change can be measured exactly with high sampling rate.

Specifications

DC voltage (DCV)	Range	100 mV to 1000 V
	Accuracy	$\pm(0.0035\%$ of reading + 0.0005% of range) at the 10 V range
DC current (DCI)	Range	1 mA to 3 A
	Accuracy	$\pm(0.050\%$ of reading + 0.005% of range) at the 100 mA range
AC voltage (ACV)	Range	100 mV to 750 V (Frequency: 20 Hz to 300 kHz, up to 100 kHz at the 750 V range)
	Accuracy	$\pm(0.06\%$ of reading + 0.03% of range) at the 1 to 750 V range and 100 Hz to 20 kHz
AC current (ACI)	Range	1 to 3 A (Frequency: 20 Hz to 5 kHz)
	Accuracy	$\pm(0.10\%$ of reading + 0.04% of range) at the 1 A range and 100 Hz to 5 kHz
Resistance measurement (2 W Ω /4 W Ω)	Range	100 Ω to 100 M Ω
	Accuracy	$\pm(0.010\%$ of reading + 0.001% of range) at the 1 M Ω range
Continuity test (CONT)	Resistance range	1 k Ω
Diode test	Measuring current	Approx. 1 mA
Temperature measurement (TEMP, TC)	Thermocouple type	R/K/T/J/E (Internal RJC is not supported)
	Temperature measurement (TEMP, RTD)	Resistance temperature detector Pt100, JPt100
Frequency measurement (FREQ)	Range	3 Hz to 300 kHz
	Accuracy	$\pm 0.01\%$ of reading at 40 Hz to 300 kHz

Model and Suffix Code

Model	Suffix Code	Description
DM7560		Digital Multimeter
Supply voltage	-1	100 VAC, 50/60 Hz
	-3	115 VAC, 50/60 Hz
	-6	220 VAC, 50/60 Hz
	-8	240 VAC, 50/60 Hz
Power cord	-D	UL/CSA standard, and PSE compliant
	-F	VDE/Korean standard
	-R	Australian standard
	-Q	British standard
	-H	Chinese standard
	-N	Brazilian standard
Options	/C1	GP-IB Interface*
	/C2	LAN & RS-232 Interface*
	/CMP	DIO Interface

*Only one can be selected.

Easily Generate Basic, Application Specific and Arbitrary Waveforms



See brochure for details: Bulletin FG400-01EN



Features

The FG400 Arbitrary/Function Generator provides a wide variety of waveforms as standard and generates signals simply and easily. There are one channel (FG410) and two channel (FG420) models. As the output channels are isolated, an FG400 can also be used in the development of floating circuits. (up to 42 V)

- 0.01 μ Hz to 30 MHz output (sine wave)
- 20 Vp-p output/open, 10 Vp-p output/50 Ω
- Arbitrary waveform generation function
- 3.5-inch color display
- Up to 6 units (12 channels) can be synchronized
- A variety of sweeps, modulations and functions
- Parameter-variable waveforms

Specifications

Number of channels	FG410: 1-channel model FG420: 2-channel model	
Output waveforms	Sine, square, pulse, ramp, DC, parameter-variable waveform (25 types), noise (Gaussian distribution), arbitrary waveform	
Oscillation modes	Continuous, modulation, sweep, burst, sequence	
Frequency	Sine	0.01 μ Hz to 30 MHz
	Square/pulse	0.01 μ Hz to 15 MHz
	Ramp/parameter-variable waveform	0.01 μ Hz to 5 MHz
Arbitrary waveform	Waveform length	4 K to 512 K words or 2 to 10000 control points
Modulation type	FM, FSK, PM, PSK, AM, DC offset, PWM	
Sweep type	Frequency, phase, amplitude, DC offset, duty	
Synchronization of multiple units	Sync operation is possible. Up to 6 units can be connected with BNC cables in the form of master/slave connections, using the frequency reference output and external 10 MHz frequency reference input	
Power supply	AC 100 V to 230 V \pm 10% (250 V max.) 50 Hz/60 Hz \pm 2 Hz	
Power consumption	FG410: 50 VA or less FG420: 75 VA or less	
Weight	Approx. 2.1 kg	
Dimensions	216 (W) \times 88 (H) \times 332 (D) mm	

Model and Suffix Code

Model	Suffix Code	Description
FG410		Arbitrary/Function Generator: 1-Channel Model
FG420		Arbitrary/Function Generator: 2-Channel Model
Power cord	-D	UL/CSA standard, and PSE compliant
	-F	VDE/Korean standard
	-R	Australian standard
	-Q	British standard
	-H	Chinese standard
	-N	Brazilian standard

Related Software

XviewerLITE

This software allows you to display the waveforms and measurement results on a PC for the data measured with Yokogawa's DLM/DL/SL series. It allows you to clip part of a waveform and generate an arbitrary waveform with the FG400.

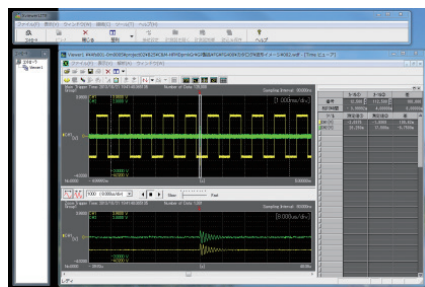

Arbitrary Waveform Editor

This software supports the arbitrary waveform function of the FG400. It allows you to edit waveforms and transfer data to the FG400. It also makes it easy to work on a pre-installed waveform to generate an arbitrary waveform.

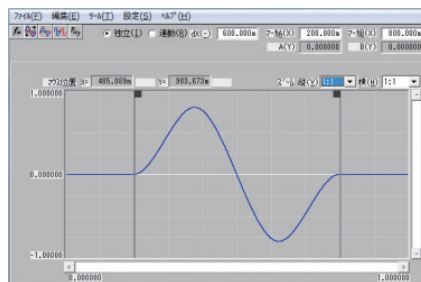

Sequence Editor

This software supports the sequence function of the FG400 that outputs different waveforms sequentially. It controls the edit, transfer, and execution of sequence data. Complex programs can also be created easily.

ステップ	波型	AFB	経過時間(μs)	種類	振幅	オフセット	同期	Duty	Duty
0	Sine	---	1000	Norm	V-FS	0	0	---	---
1	Sine	---	1000	Norm	V-FS	0	0	---	---
2	Sine	---	1000	Norm	V-FS	0	0	---	---
3	Sine	---	1000	Norm	V-FS	0	0	---	---
4	Sine	---	1000	Norm	V-FS	0	0	---	---
5	Sine	---	1000	Norm	V-FS	0	0	---	---
6	Sine	---	1000	Norm	V-FS	0	0	---	---
7	Sine	---	1000	Norm	V-FS	0	0	---	---
8	Sine	---	1000	Norm	V-FS	0	0	---	---
9	Sine	---	1000	Norm	V-FS	0	0	---	---
10	Sine	---	1000	Norm	V-FS	0	0	---	---

High Accuracy and Long Term Stability



See brochure for details: Bulletin 7674-01E

Features

- **High accuracy: $\pm 0.05\%$ of full scale**
- **Output ranges and resolution**
 - 0 to 25 kPa range model (767401):
0 to 25 kPa (resolution 0.001 kPa)
 - 0 to 200 kPa range model (767402):
0 to 200 kPa (resolution 0.01 kPa)
- **Useful functions for instrument calibration**
Divided output, auto-step output, and sweep output
- **Excellent temperature coefficient**
 - Zero point: $\pm 0.003\%$ of full scale/ $^{\circ}\text{C}$
 - Span: $\pm 0.002\%$ of full scale/ $^{\circ}\text{C}$

Functions

Divided output function with as many as 20 steps.

Outputs a pressure equal to the specified value $\times n/m$ ($n = 0$ to m , $m = 1$ to 20)

Auto-step output function

Divider output is automatically generated in steps.

- Interval time: 10 to 600 seconds in 5-second intervals
- Repetitions: One to infinity
(stopping partway through is also permitted)

Sweep output function

The generated pressure is increased or decreased linearly over the interval time from 0% to 100% of the set pressure.

Specifications

Main Specifications

Supplied input	50 \pm 10 kPa (767401)/280 \pm 20 kPa (767402)
Max. allowable input	100 kPa gauge (767401)/500 kPa gauge (767402)
Output noise	$\pm 0.02\%$ of full scale
Influence of positional setup	90° tilt forward or backward: $\pm 0.1\%$ of full scale (767401)/ $\pm 0.01\%$ of full scale (767402)
	30° tilt right or left: $\pm 2.5\%$ of full scale (767401)/ $\pm 0.2\%$ of full scale (767402)
Readout unit (Select from the following when ordered)	kPa only; kPa, kgf/cm ² , mmHg, mmH ₂ O (selectable); kPa, inH ₂ O, inHg, psi (selectable)
Supply pressure source	Dry air only. Temperature must be between 5°C and 40°C, and the amount of temperature change must be small.
Air consumption rate	Approx. 30 L/min (with supply pressure in specified range)

Basic Specifications

Warm-up time	Approx. 5 min
Operating temperature and humidity	5°C to 40°C, 20 to 80%RH, no condensation
Maximum operating altitude	2000 m
Storage temperature range	-20°C to 60°C
AC power ratings	100 to 120 VAC/200 to 240 VAC, at 50/60 Hz
Power consumption	40 VA Max. (100 to 120V)/50 VA Max. (200 to 240 V)
Dimensions	Approx. 213 mm (W) \times 132 mm (H) \times 400 mm (D), excluding protrusions
Weight	Approx. 9.5 kg

Model and Suffix Code

Model	Suffix Code	Description
767401		Pneumatic pressure Standard (25 kPa range model)
767402		Pneumatic pressure Standard (200 kPa range model)
Pressure unit	-U1	Displayed unit: kPa
	-U2	Displayed unit: kPa, kgf/cm ² , mmH ₂ O, and mmHg
	-U3	Displayed unit: kPa, psi, inH ₂ O, and inHg
Communication function	-C1	GP-IB interface
	-C2	RS-232 interface
I/O connection unit	-P1	Rc 1/4" female-thread
	-P2	1/4" NPT female-thread
Power cord	-D	UL/CSA standard, and PSE compliant
	-F	VDE/Korean standard
	-R	Australian standard
	-Q	British standard
	-H	Chinese standard
	-N	Brazilian standard
	-T	Taiwanese standard
	-B	Indian standard
	-U	IEC Plug Type B

High Accuracy and Long Term Stability

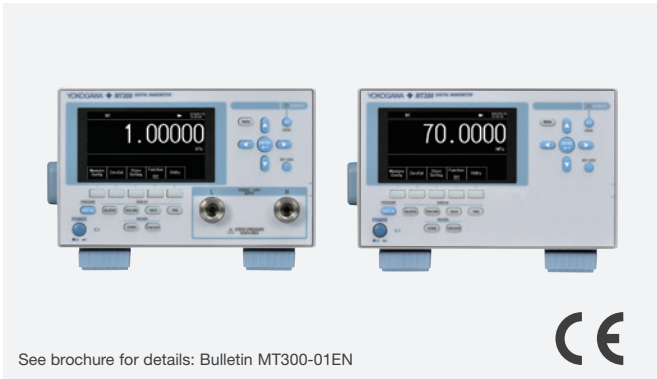

See brochure for details: Bulletin MT300-01EN

Features

- **High accuracy and long term stability**
 - **Relative accuracy*** of pressure measurement: 0.01%
*Relative value for the measure toward the working standard of YOKOGAWA.
 - Accuracy guarantee period: 12 months
- **Rich lineup**
 - Gauge pressure models:
10 kPa, 200 kPa, 1000 kPa, 3500 kPa, 16 MPa, 70 MPa
 - Absolute pressure models: 130 kPa, 700 kPa, 3500 kPa
 - Differential pressure models: 1 kPa, 10 kPa, 130 kPa, 700kPa

Functions

For High precision measurements

- High resolution display (When /R1 is selected.)
- Synchronous measurement
- High speed measurement (When /F1 is selected.)

Support for efficient works

- Leak test
- Scaling
- Statistical processing (Max, Min, Avg and σ)

Support for linkage with external devices

- D/A output (When /DA is selected)
- Comparator output
- GPIB, USB (type-B), and ETHERNET are available as standard features.

Battery operation

- Running time: Approx. 6 hours with all functions turned on
- Charge time: Approx. 6 hours

Specifications

Main Specifications

Display resolution	6 digits Max. (7 digits Max. when /R1 is selected)	
Guaranteed accuracy range	G01 (10 kPa gauge pressure model)	-10 kPa to 10 kPa
	G03 (200 kPa gauge pressure model)	-80 kPa to 200 kPa
	G05 (1000 kPa gauge pressure model)	-80 kPa to 1000 kPa
	G06 (3500 kPa gauge pressure model)	-80 kPa to 3500 kPa
	G07 (16 MPa gauge pressure model)	0 kPa to 16000 kPa
	G08 (70 MPa gauge pressure model)	0 kPa to 70000 kPa
	A03 (130kPa absolute pressure model)	0 kPa to 130 kPa abs
	A05 (700kPa absolute pressure model)	0 kPa to 700 kPa abs

A06 (3500kPa absolute pressure model)	0 kPa to 3500 kPa abs
D00 (1 kPa Differential pressure model)	0 kPa to 1 kPa
D01 (10 kPa Differential pressure model)	0 kPa to 10 kPa
D03 (130 kPa Differential pressure model)	0 kPa to 130 kPa
D05 (700 kPa Differential pressure model)	0 kPa to 700 kPa
Readout unit	Pa, hPa, kPa, MPa, mbar, bar, atm only, or add mmHg, inHg, gf/cm ² , kgf/cm ² , Torr, psi, mmH ₂ O@4°C, mmH ₂ O@20°C, ftH ₂ O@4°C, ftH ₂ O@20°C, inH ₂ O@4°C, inH ₂ O@20°C
Applicable fluids	Gases and liquid (non-flammable, non-explosive, non-toxic and non-corrosive fluids)

Basic Specifications

Display device	4.3-inch TFT color LCD
Warm-up time	Approx. 5 min
Operating temperature and humidity	5°C to 40°C, 20 to 80%RH, no condensation 10°C to 35°C, 20 to 80%RH, no condensation (when -D00 is selected)
Operating altitude range	2000 m or less
Storage temperature range	-20°C to 60°C RH, no condensation
Power Supply	AC or Li-ion battery (739883) with battery pack cover (269918)
AC power rating	100 to 120 VAC/200 to 240 VAC, at 50/60 Hz
Dimensions	Approx. 213 mm (W) × 132 mm (H) × 350 mm (D), excluding protrusions
Weight	Approx. 6.2 kg (When -G03 selected.)

Model and Suffix Code

Model	Suffix Code	Description	
MT300		Digital Manometer	
Pressure type and range	-G01	10 kPa range Gauge pressure model	
	-G03	200 kPa range Gauge pressure model	
	-G05	1000 kPa range Gauge pressure model	
	-G06	3500 kPa range Gauge pressure model	
	-G07	16 MPa range Gauge pressure model	
	-G08 ^{*1}	70 MPa range Gauge pressure model	
	-A03	130 kPa range Absolute pressure model	
	-A05	700 kPa range Absolute pressure model	
	-A06	3500 kPa range Absolute pressure model	
	-D00	1 kPa range Differential pressure model	
Pressure unit	-U1	Pa, hPa, kPa, MPa, mbar, bar, atm	
	-U2	Pa, hPa, kPa, MPa, mbar, bar, atm, mmHg, inHg, gf/cm ² , kgf/cm ² , Torr, psi, mmH ₂ O@4°C, mmH ₂ O@20°C, ftH ₂ O@4°C, ftH ₂ O@20°C, inH ₂ O@4°C, inH ₂ O@20°C	
	Input connection	-P1	Rc 1/4" female-thread
		-P2	1/4" NPT female-thread
		-P3	VCO 1/4" male-thread
-P4 ^{*2}		1/2" NPT female-thread	
Power cord	-D	UL/CSA standard, and PSE compliant	
	-F	VDE/Korean standard	
	-Q	British standard	
	-R	Australian standard	
	-H	Chinese standard	
	-N	Brazilian standard	
	-T	Taiwanese standard	
	-B	Indian standard	
	-U	IEC Plug Type B	
	Option	/F1 ^{*3}	Measurement mode switching function (Normal, Medium or High)
/DM ^{*4}		DCV/DCA measurement, 24 VDC output	
/DA		DA conversion output	
/R1 ^{*5}		One additional display resolution digit	
/EB		Battery pack + battery pack cover	

*1: -G08 is shield gauge pressure model.

*2: When -G08 is selected, only -P4 can be selected for -G08.

*3: Not selectable for -G07, -G08, or the differential pressure model.

*4: Selectable on the gauge pressure model and absolute pressure model.

*5: Not selectable for -G08 or -D00.

High Performance Optical Spectrum Analyzers Meeting Measurement Needs in a Broad Range of Applications



Yokogawa offers diffraction grating based optical spectrum analyzers with high-speed and high-performance that meets the measurement needs of a wide range of R&D and industrial manufacturing applications.

An extensive product lineup covers a wide wavelength range from visible to mid-wavelength infrared (350 to 5500 nm). This document will help you choose the best model for your measurement needs.

Features

Best-in-class optical performance

- High wavelength resolution and high dynamic range
- High sensitivity
- Free-space optical input*

*Except AQ6380

Excellent measurement throughput

- High-speed spectrum measurement
- High-speed remote interface
- High resolution and wide bandwidth batch measurement

More user-friendly

- USB interface available
- For mouse, keyboard, and external storage devices such as a memory device and hard disc drive (HDD).
- Trace zooming function
- More than 10 waveform analysis functions available

Support for creating an automatic measurement system

- GP-IB, RS-232C*, and Ethernet interfaces available
- Support for the remote commands and formats of the AQ6317 series
- Macro programming function available

*AQ6377 only

Wavelength calibration reference light source or alignment light source available

AQ6370 Viewer emulation and remote control software (option)

Three Models Converting a Wide Wavelength from 350 nm to 5500 nm

AQ6380 (1200 to 1650 nm)

Best Performance Optical Spectrum Analyzer for R&D of Next Generation Optical Networks

AQ6370E (600 to 1700 nm)

The OSA market leader in the telecom industry

AQ6360 (1200 to 1650 nm)

Our fastest OSA optimized for optical device manufacturing

AQ6373E (350 to 1200 nm)

The high-performance OSA optimized for visible laser measurement

AQ6374E (350 to 1750 nm)

Wide range OSA covering from visible light to communications wavelength

AQ6375E (1000 to 2500 nm)

The long wavelength OSA covering SWIR region

AQ6376E (1500 to 3400 nm)

The long wavelength OSA covering SWIR and MWIR region

AQ6377 (1900 to 5500 nm)

The long wavelength OSA covering MWIR region

Optical Applications

Optical technology is used in a wide variety of applications, which include biomedical application and environmental measurement, as well as information and communications, where demand for broadband connectivity is growing rapidly, driven by the popularity of the Internet and video streaming.

Yokogawa's optical spectrum measurement technology contributes to the development of such optical applications.

Wavelength range for each model

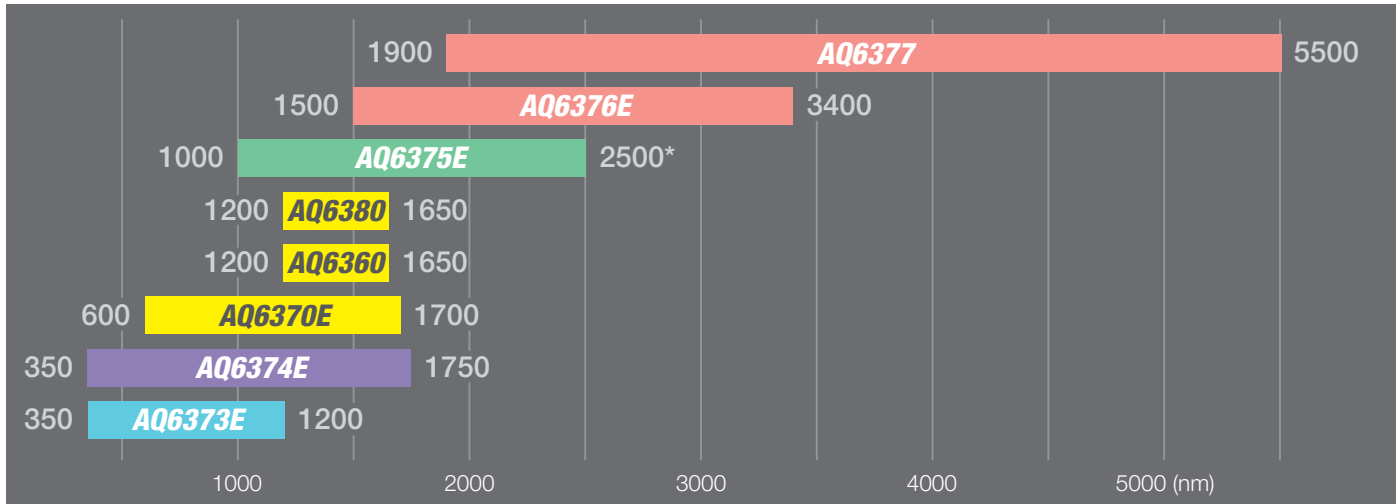

*Wavelength extended model

Biomedical Application

Evaluating the performance of high performance filters for a visible light laser and fluorescence extraction

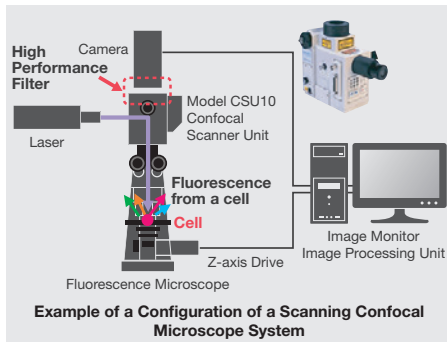

Information & Communication Application

Evaluating the performance of optical components, such as a laser, optical multiplexer, optical demultiplexer and optical amplifier, as well as the system as a whole

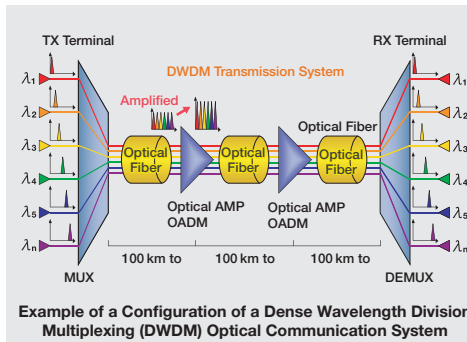

Environmental Measurement Application

- Evaluating the performance of optical components such as a laser and grating
- Evaluating the light absorption characteristics of gases

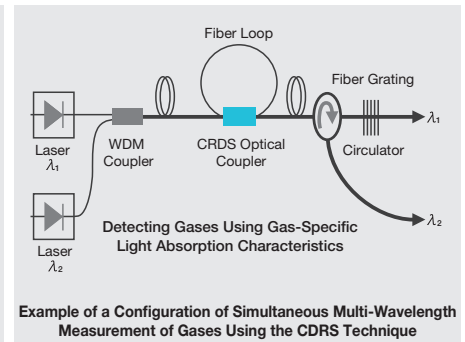

Specifications Optical Spectrum Analyzer Common Specifications

	AQ6380/AQ6370E/AQ6373E/AQ6374E/AQ6375E/AQ6376E	AQ6377	AQ6360
Electrical interface	GP-IB, Ethernet, USB, VGA output, Analog output port, Trigger input port, Trigger output port	GP-IB, RS-232, Ethernet, USB, SVGA output, Analog output port, Trigger input port, Trigger output port	GP-IB, Ethernet, USB, SVGA output
Remote control*1	GP-IB, Ethernet (TCP/IP), SCPI (IEEE488.2), AQ6317 series compatible commands (IEEE488.1)	GP-IB, RS-232, Ethernet (TCP/IP), AQ6317 series compatible commands (IEEE488.1) and IEEE488.2	GP-IB, Ethernet (TCP/IP), AQ6317 series compatible commands (IEEE488.1) and IEEE488.2
Purge gas input/output terminals	Outer diameter 1/4 nylon tube (inch size)*2		—
Data storage			
Internal storage	512 MBytes		
External storage	USB storage (memory/HDD)		
File types	CSV (text), Binary, BMP, PNG, JPEG	CSV (text), Binary, BMP, TIFF	
Display*3	10.4-inch color LCD (Capacitive touchscreen, Resolution: 1024 × 768 pixels)	10.4-inch color LCD (Resolution: 800 × 600 pixels)	8.4-inch color LCD (Touchscreen, Resolution: 800 × 600 pixels)
Dimensions (Excluding protector and handle)	Approx. 426 (W) × 221 (H) × 459 (D) mm		Approx. 426 (W) × 177 (H) × 459 (D) mm
Mass	AQ6380: Approx. 25 kg AQ6370E/AQ6373E/AQ6374E: Approx. 19 kg AQ6375E/AQ6376E: Approx. 22 kg	Approx. 23 kg	Approx. 15.5 kg
Power requirements	100 to 240 V AC, 50/60 Hz, approx. 100 VA		
Environmental conditions			
Performance guarantee temperature	+20 to +26°C (AQ6380) +18 to +28°C (Except AQ6380)	+18 to +26°C	+18 to +28°C
Operating temperature	+5 to +35°C	+5 to +33°C	+5 to +35°C
Storage temperature	-10 to +50°C		
Humidity	20 to 80%RH (no condensation)		

*1: Some AQ6317 series commands may not be compatible due to changes in specifications or functions. *2: AQ6380, AQ6374E, AQ6375E, AQ6376E and AQ6377

*3: Liquid crystal display may include a few defective pixels (within 0.002% with respect to the total number of pixels including RGB). There may be a few pixels on the liquid crystal display that do not emit all the time or remains ON all the time. These are not malfunctions.

Specifications and Features

Wavelength band/Feature/Model			Wavelength range (nm)		Wavelength resolution (nm)		Wavelength accuracy (nm)				
					Max.	Min.	VIS 0.6 μm	Optical comm.			Full range
								1.31 μm	1.55 μm	1.6 μm	
VIS	High resolution	AQ6373E	350	1200	10	0.01 ^{*1} (350 to 600 nm) 0.02	±0.05				±0.2
VIS Optical comm.	Wide band	AQ6374E	350	1750	10	0.05	±0.05	±0.2	±0.05	±0.2	±0.2
Optical comm.	High performance	AQ6370E	600	1700	2	0.02		±0.1	±0.008 _{typ.}	±0.015 _{typ.}	±0.1
	Highest performance	AQ6380	1200	1650	2	0.005		±0.05	±0.005	±0.01	±0.05
	High speed & Space saving	AQ6360	1200	1650	2	0.1		±0.1	±0.02	±0.04	±0.1
SWIR	2 μm	AQ6375E	1000	2500 ^{*3}	2	0.05		±0.5	±0.05	±0.1	±0.5
MWIR	3 μm	AQ6376E	1500	3400	2	0.1			±0.5	±0.5	±0.5
	5 μm	AQ6377	1900	5500	5	0.2					±0.5

*1: High resolution model *2: Purge feature for the AQ6360 are available on request. *3: Wavelength extended model

Applications

Optical communications

- Emission spectrum evaluation of optical transceivers, LD chips, and LD modules
- OSNR measurement of WDM transmission signals
- Optical Amplifier testing
- Wavelength-dependent loss characterization of optical fiber

VIS

- Characterization of light sources used in biomedical and consumer products
- Color analysis of visible LED

SWIR MWIR

- Characterization of cascade lasers used in Laser Absorption Spectroscopy
- Characterization of broadband light such as optical frequency combs and supercontinuum light sources
- Spectral measurement of nonlinear lasers such as optical parametric oscillators

VIS: Visible, SWIR: Short-wavelength infrared, MWIR: Mid-wavelength infrared



Close-in dynamic range (dB)						Level sensitivity (dBm)			Applicable fiber			Purge feature	Higher-order diffracted light suppression	
Resolution minimum		Resolution 0.02 nm		Resolution 0.1 nm		VIS ≤ 1 μm	Optical comm. 1.3-1.6 μm	SWIR ≤ 2.2 μm	SWIR/MWIR ≥ 2.2 μm	SM	GI			Large core
60 (±0.5nm)		60 (±0.5nm)				-80 typ. (500 to 1000nm) -60 typ. (400 to 500nm)				●	●	●		●
60 (±1.0nm)						-70 (400 to 900nm)	-80			●	●	●	●	●
45 (±0.1nm)	58 (±0.2nm)	45 (±0.1nm)	58 (±0.2nm)	50 typ. (±0.2nm)	67 typ. (±0.4nm)	-60 (600 to 1000nm)	-90			●	●	●		
45 (±0.05nm)	60 (±0.1nm)	55 (±0.1nm)	65 (±0.2nm)	55 typ. (±0.2nm)	67 typ. (±0.4nm)		-85			●			●	●
40 (±0.2nm)	55 (±0.4nm)			40 (±0.2nm)	55 (±0.4nm)		-80			●	●		*2	
45 (±0.4nm)	55 (±0.8nm)						-62	-67 (1500 to 1800nm) -70 (1800 to 2200nm)	-67 (2200 to 2400nm)	●	●	●	●	●
45 (±1.0nm)	55 (±2.0nm)							-65 (1500 to 2200nm)	-55 (2200 to 3200nm)	●	●	●	●	●
50 typ. (±5.0nm)								-40 typ. (1900 to 2200nm)	-50 typ. (2200 to 2900nm) -60 typ. (2900 to 4500nm)	●	●	●	●	●

● : Available

Related Product

AQ6150 Series Optical Wavelength Meters

The AQ6150B and AQ6151B Optical Wavelength Meters are fast, accurate and cost-effective instruments for carrying out measurements in the telecommunications wavelength range from 900 to 1700 nm.



AQ2200 Series Multi-Application Test System (MATS)

The AQ2200 series is an ideal test platform for measuring and evaluating a variety of optical devices and transmission systems. Various measurement modules can be mounted in any combination on a single frame.

Frame and module lineup:

Products	Descriptions
Frame controllers	3 slots type, 9 slots type
Light source modules	High output level stability light sources, Grid TLS
Sensor modules	High power type, Large-diameter sensor head, dual sensor type
Optical attenuator modules	Standard type, with monitor output, with built-in monitor power meter
Optical switch modules	1×2, 2×2, 1×4, 1×8, and 1×16 channels
Modules for Optical Transceiver	—



Best Performance Optical Spectrum Analyzer for R&D of Next Generation Optical Networks

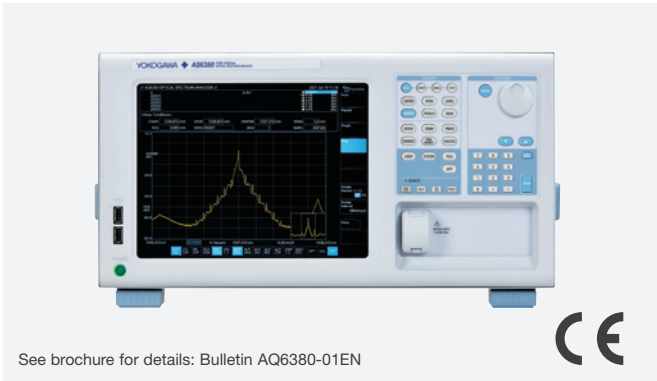

See brochure for details: Bulletin AQ6380-01EN

Features

Unparalleled optical performance

- High wavelength resolution: 5 pm
- High wavelength accuracy: ± 5 pm
- Wide close-in dynamic range: 65 dB
- High stray-light suppression: 80 dB

Fast measurement

New sensitivity mode "RAPID" increases measurement speed.

Automated wavelength calibration

- Fully automated periodical wavelength calibration with a built-in light source
- Semi-automated wavelength calibration with an external light source

Gas purging mechanism

- Reduction of the influence of water vapor absorption spectrum shown around 1380 nm

Large touchscreen LCD

- Inheriting the easy-to-use operability proven by many users
- Touchscreen makes operations even more intuitive.

DUT oriented test apps (APP)

- Pre-installed test apps
- New apps and custom apps can be added.

Excellent adaptability to various applications

- Lasers and optical transceivers (PEAK, SMSR, OSNR)
- Optical amplifiers (Gain, Noise figure)
- Broadband light
- Passive optical components; Optical fibers, optical filters, FBG (Fiber Bragg Grating), ROADM (Reconfigurable Optical Add-Drop Multiplexer), WSS (Wavelength Selective Switch)

Unparalleled optical performance

5 pm high wavelength resolution

The AQ6380 enables to separate closely allocated modulation side peaks of optical transceivers.

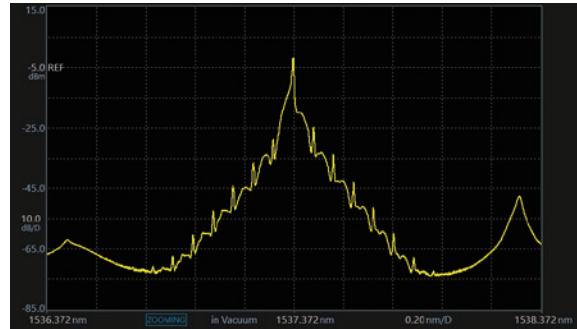

Modulated spectrum of 10 G optical transceiver

80 dB stray light suppression

The AQ6380 provides high dynamic range measurements with excellent stray light suppression performance, with no spurious noise generated.



Stray light suppression performance

Up to 20x faster measurement

The AQ6380 is equipped with a new sensitivity mode (RAPID) for fast measurement.

Comparison with our conventional model

Model	Measurement time	SENS setting
AQ6380	0.23 s	RAPID1 (avg. 3)
AQ6370D	5.4 s	NORM_AUTO

Automated wavelength calibration

- Wavelength calibration with the internal light source can be performed fully automatically and regularly without an external fiber cord.
- It also supports wavelength calibration using an external light source. Calibration can be performed by setting the exact wavelength of the external light source.

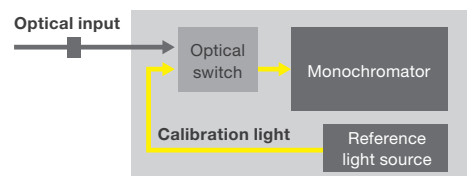

Gas purging mechanism for minimizing the water vapor absorption

The AQ6380 is equipped with a purge mechanism that replaces the air inside the monochromator with nitrogen or dry air by continuously supplying it through dedicated ports on the back panel. Therefore, it can realize accurate optical spectrum measurements without being affected by the light absorption phenomenon of water vapor.

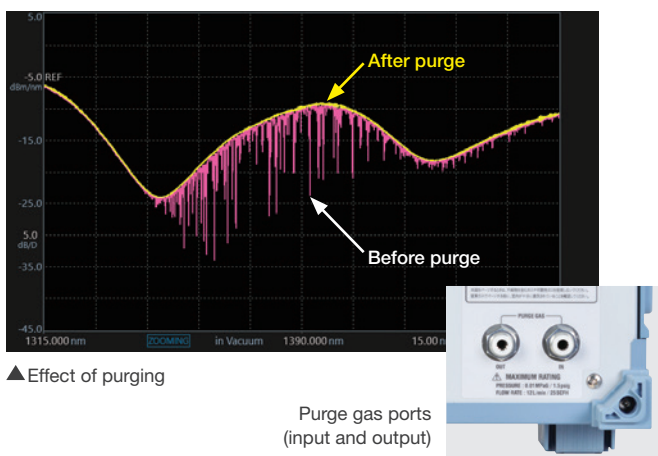

Large touchscreen LCD

The high-resolution, responsive 10.4-inch multi-touch capacitive touchscreen makes device operation even simpler and more intuitive. You can change measurement conditions, perform analysis, change the optical spectrum view as if you were operating a tablet device. In the optical spectrum view, the waveform view can be zoomed or shifted by a simple tap and drag.



DUT-oriented test apps (APP) simplifies the test process

Application (APP) mode transforms a versatile OSA into a machine dedicated to a device under test (DUT). APP mode provides a DUT-specific user interface that navigates the user from configuration settings to test result output without the user being aware of the wide variety of OSA settings.



Basic process of test applications



WDM test application

OSA Viewer enables emulation and remote control on a PC

You can emulate and remote control the AQ6380 using PC application software called the OSA viewer, which is included in the AQ6370 Viewer.

The OSA Viewer has a user interface and analysis capabilities, allowing R&D and production users to easily view and analyze AQ6380 waveforms on their remote PC or laptop.

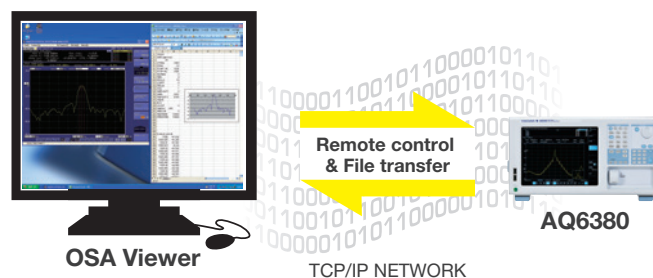

Note. The OSA Viewer is optional.

Specifications

Applicable fiber	SM (9.5/125)
Wavelength range	1200 to 1650 nm
Wavelength accuracy	±0.005 nm (1520 to 1570 nm), ±0.01 nm (1450 to 1520 nm, 1570 to 1620 nm), ±0.05 nm (full span)
Wavelength resolution setting	0.005, 0.01, 0.02, 0.05, 0.1, 0.2, 0.5, 1, 2 nm, and arbitrary resolutions (0.01 to 2 nm in 0.01 nm steps)
Min. sampling resolution	0.0005 nm (0.5 pm)
Level sensitivity	TRAD mode -85 dBm (1200 to 1600 nm, sensitivity: HIGH3) RAPID mode -72 dBm (1200 to 1600 nm, sensitivity: RAPID6)
High dynamic range mode	SWITCH (sensitivity: MID, HIGH1-3, and RAPID4-6)
Level accuracy	±0.5 dB (1310 & 1550 nm, input level: -20 dBm, sensitivity: MID, HIGH1-3, and RAPID4-6)
Close-in dynamic range	RES 0.005 nm 60 dB (peak ±0.1 nm), 45 dB (peak ±0.05 nm) RES 0.02 nm 65 dB (peak ±0.2 nm), 55 dB (peak ±0.1 nm)
Optical input connector	FC/PC or SC/PC
Measurement time	0.2 s (sensitivity: RAPID1, span: 100 nm, number of sampling: 100001, number of averaging: 1)
Built-in light source	Wavelength reference light source dedicated to auto-calibration (-L1)
Warm-up	Minimum 1 hour

Please refer to the product brochure for details.

Model and Suffix Code

Model	Suffix Code	Description
AQ6380		AQ6380 Optical Spectrum Analyzer
	Spec code	-10 Standard model
	Built-in light source	-L1 Wavelength reference source
	Optical input connector	-FCC FC/PC -SCC SC/PC
	Power cord	-D UL/CSA standard and PSE compliant, 125 V -F VDE/Korean standard, 250 V -R Australian standard, 250 V -Q British standard, 250 V -H Chinese standard, 250 V -N Brazilian standard, 250 V -T Taiwanese standard, 125 V -B Indian standard, 250 V -U IEC Plug Type B, 250 V

The OSA Market Leader in the Telecom Industry

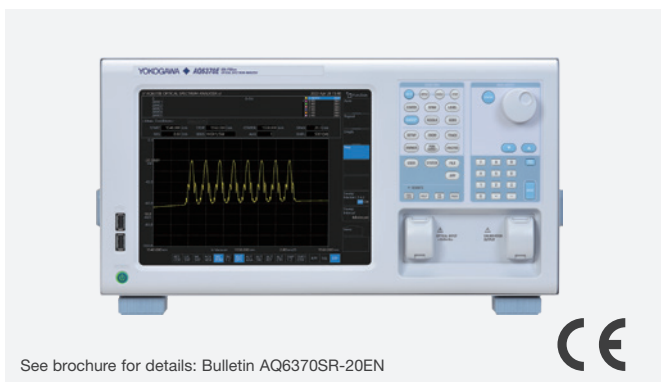

See brochure for details: Bulletin AQ6370SR-20EN



Features

Standard and High performance models

There are two models available, with the High performance model providing even higher wavelength accuracy and dynamic range.

Wavelength range: 600 to 1700 nm

Due to its broad wavelength range coverage, AQ6370E is suitable to test devices designed for single-mode as well as multimode transmissions.

7 wavelength resolution settings: 20 pm to 2 nm

Enables the user to choose the best value according to the characteristics of the DUT.

7 level sensitivity settings: down to -90 dBm

Enables the user to choose the best value according to test applications and measurement speed requirements.

Up to 2x faster SMSR measurement: SMSR mode

The SMSR mode is the sensitivity setting dedicated for measuring the laser's SMSR faster. It can measure the SMSR up to twice as fast as the conventional sensitivity mode (TRAD MIDx2).

Note: Fast measurement may not be possible depending on the level of the optical spectrum.

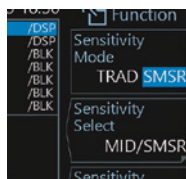

APC connector level correction function

Corrects the level offset caused by the higher insertion loss of Angled PC connectors.

Resolution calibration function

Calibrates the resolution bandwidth with an external light source. With this new feature, the measurements of power spectral density of a broad spectrum light source will be more accurate.

High wavelength accuracy: ±0.008 nm typ.

The high wavelength accuracy is achieved in the S, C, and L bands. The AQ6370E also has the high wavelength accuracy of ±0.1 nm over the whole wavelength range. The high wavelength accuracy can be maintained by calibrating with the wavelength reference source (optional) or the external light source.

Wavelength range	Standard (-10)	High performance (-20)	Note:
1520 to 1580 nm	±0.015 nm	±0.008 nm	The wavelength accuracy values in the table are typical values.
1450 to 1520 nm		±0.015 nm	
1580 to 1620 nm		±0.015 nm	

High close-in dynamic range: 78 dB typ.

The AQ6370E monochromator has sharp spectral characteristics, so signals in close proximity can be clearly separated and accurately measured.

Sharper spectrum measurement: HCDR mode

The HCDR (High Close-in Dynamic Range) mode is a feature for single longitudinal mode laser measurements that makes the spectrum around the peak sharper and the side modes more clearly visualized.

This mode is only available on the High performance model (-20).

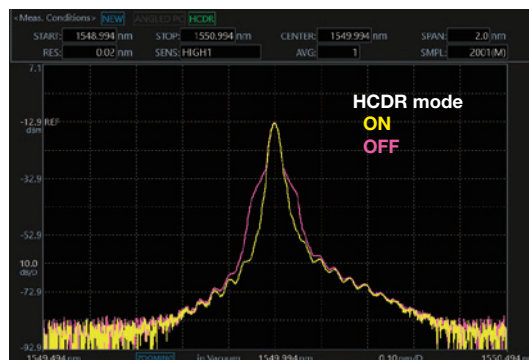

Example of HCDR mode
Resolution setting 0.02 nm, High performance model

DUT oriented test apps (APP)

Applications

WDM OSNR test

AQ6370E's wide close-in dynamic range allows accurate OSNR measurement of DWDM transmission systems. The built-in WDM analysis function analyzes the measured waveform and shows peak wavelength, peak level, and OSNR of WDM signals up to 1024 channels simultaneously. The Curve Fit function is used to accurately measure noise levels.

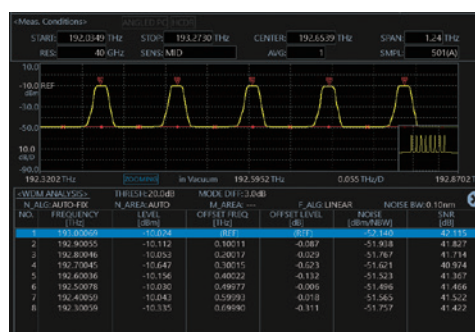
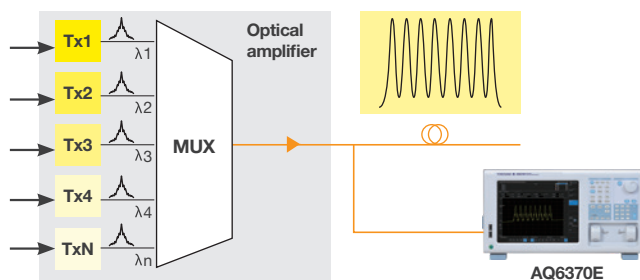

Example of WDM OSNR analysis

Specifications

		Standard (-10)	High performance (-20)
Wavelength range ^{*1}		600 to 1700 nm	
Span ^{*1}		0.1 nm to 1100 nm (Full span), and 0 nm	
Wavelength accuracy ^{*1, *2, *5}		±0.02 nm (1450 to 1620 nm, ±0.015nm typ.) ±0.10 nm (Full range)	±0.01 nm (1520 to 1580 nm, ±0.008 nm typ.), ±0.02 nm (1450 to 1520 nm, 1580 to 1620 nm, ±0.015 nm typ.), ±0.10 nm (Full range)
Wavelength linearity ^{*1, *2, *5}		±0.01 nm (1520 to 1580 nm), ±0.015 nm (1450 to 1520 nm, 1580 to 1620 nm)	
Wavelength repeatability ^{*1, *2}		±0.005 nm (1 min.)	
Wavelength resolution setting ^{*1, *2}		0.02, 0.05, 0.1, 0.2, 0.5, 1 and 2 nm	
Wavelength resolution bandwidth accuracy ^{*1, *2}		±5% (1450 to 1620 nm, Resolution setting: ≥ 0.1 nm, after performing the Resolution Calibration function, at the wavelength of resolution calibration)	
Min. sampling resolution ^{*1}		0.001 nm	
Number of sampling		101 to 200001, AUTO	
Level sensitivity setting	TRAD mode	NORM_HOLD, NORM_AUTO, NORMAL, MID, HIGH1, HIGH2, HIGH3	
	SMSR mode	MID/SMSR, HIGH1/SMSR	
High dynamic mode		SWITCH (Sensitivity: MID, HIGH1-3)	
Level sensitivity ^{*2, *3, *4, *7}		-90 dBm (1300 to 1620 nm), -85 dBm (1000 to 1300 nm), -60 dBm (600 to 1000 nm) (Sensitivity: HIGH3)	
Maximum input power ^{*2, *3}		+20 dBm (Per channel, full range)	
Maximum safe input power ^{*2, *3}		+25 dBm (Total input power)	
Level accuracy ^{*2, *3, *4, *6}		±0.4 dB (1310/1550 nm, Input level: -20 dBm, Sensitivity: MID, HIGH1-3)	
Level linearity ^{*2, *3}		±0.05 dB (Input level: -50 to +10 dBm, Sensitivity: HIGH1-3)	
Level flatness ^{*2, *3, *6}		±0.1 dB (1520 to 1580 nm), ±0.2 dB (1450 to 1520 nm, 1580 to 1620 nm)	
Polarization dependence ^{*2, *3, *6}		±0.05 dB (1550/1600 nm), ±0.08 dB (1310 nm)	
Dynamic range ^{*1, *2, *8}	Resolution: 0.02 nm	55 dB (Peak ±0.2 nm), 37 dB (Peak ±0.1 nm)	58 dB (Peak ±0.2 nm, 60 dB typ.), 45 dB (Peak ±0.1 nm, 50 dB typ.)
	Resolution: 0.05 nm	73 dB (Peak ±1.0 nm), 62 dB (Peak ±0.4 nm), 45 dB (Peak ±0.2 nm)	73 dB (Peak ±1.0 nm, 78 dB typ.), 64 dB (Peak ±0.4 nm, 70 dB typ.), 50 dB (Peak ±0.2 nm, 55 dB typ.)
	Resolution: 0.1 nm	57 dB (Peak ±0.4 nm), 40 dB (Peak ±0.2 nm)	60 dB (Peak ±0.4 nm, 67 dB typ.), 45 dB (Peak ±0.2 nm, 50 dB typ.)
Stray-light suppression ratio ^{*7, *10}		73 dB	76 dB (80 dB typ.)
Optical return loss ^{*11}		35 dB typ. (with angled-PC connector)	
Applicable fiber		SM (9.5/125), MM (GI 50/125, GI 62.5/125, Large core: up to 200 μm)	
Optical connector		Optical input: AQ9447 (□□) Connector adapter (option) required. Calibration output: AQ9441 (□□) Connector adapter (option) required. (□□) Connector type FC or SC	
Built-in calibration light source ^{*12}		Wavelength reference source (For optical alignment and wavelength calibration)	
Sweep time ^{*1, *7, *9}		NORM_AUTO: 0.2 s, NORMAL: 1 s, MID: 2 s, HIGH1: 5 s, HIGH2: 20 s, HIGH3: 75 s	
Warm-up time		Minimum 1 hour (After warming up, optical alignment adjustments required.)	

*1: Horizontal scale: Wavelength display mode.

*2: With 9.5/125 μm single mode fiber with a PC type connector, after 1 hour of warm-up, after optical alignment with built-in reference light source or a single longitudinal mode laser (wavelength 1520 to 1560 nm, peak level ≥ -20 dBm, level stability ≤ 0.1 dBpp, and wavelength stability ≤ ±0.01 nm).

*3: Vertical scale: Absolute power display mode, resolution setting: ≥ 0.05 nm, resolution correction: OFF.

*4: With 9.5/125 μm single mode fiber (B1.1 type defined on IEC60793-2, PC polished, mode field diameter: 9.5 μm, NA: 0.104 to 0.107).

*5: After wavelength calibration with built-in reference light source or a single longitudinal mode laser (wavelength 1520 to 1560 nm, peak level ≥ -20 dBm and absolute wavelength accuracy ±0.003 nm).

*6: Temperature condition changes to 23 ±3°C at 0.05 nm resolution setting.

*7: High dynamic mode: OFF, pulse light measurement mode: OFF, resolution correction: OFF.

*8: 1523 nm, high dynamic mode: SWITCH, resolution correction: OFF

*9: Span: ≤ 100 nm, number of sampling: 1001, average number: 1.

*10: With He-Ne laser (1523 nm), 0.1 nm resolution setting, 1520 nm to 1620 nm except for peak wavelength ±2 nm.

*11: With Yokogawa's master single mode fiber with an angled-PC connector. 15 dB typ. with PC connector.

*12: Option.
"Typical" or "typ." in this document means "Typical value", which is for reference, not guaranteed specification.

Model and Suffix Code

Model	Suffix Code	Description	
AQ6370E		AQ6370E Optical Spectrum Analyzer	
Spec code	-10	Standard model	
	-20	High performance model	
Built-in light source	-L0	Without light source	
	-L1	Wavelength reference source	
Power cord	-D	UL/CSA standard and PSE compliant, 125 V	
	-F	VDE/Korean standard, 250 V	
	-R	Australian standard, 250 V	
	-H	Chinese standard, 250 V	
	-Q	British standard, 250 V	
	-N	Brazilian standard, 250 V	
	-T	Taiwanese standard, 125 V	
	-B	Indian standard, 250 V	
	-U	IEC Plug Type B, 250 V	
Factory installed options	/FC	AQ9447 (FC) Connector Adapter	For Optical Input
	/SC	AQ9447 (SC) Connector Adapter	
	/RFC	AQ9441 (FC) Connector Adapter	For Calibration Output
	/RSC	AQ9441 (SC) Connector Adapter	

The High-Performance OSA Optimized for Visible Laser Measurement



See brochure for details: Bulletin AQ6370SR-20EN

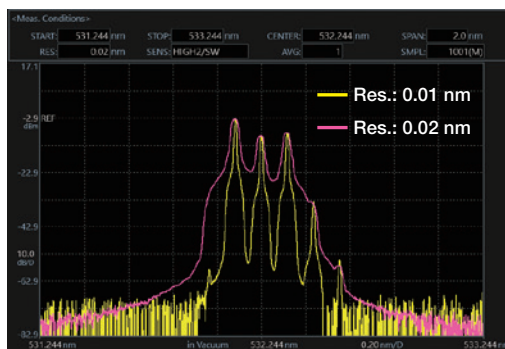

Example of visible laser measurement with high-resolution model

Features

Wavelength range: 350 to 1200 nm

Wavelength resolution settings:
0.01 to 10 nm [High resolution]
0.02 to 10 nm [Standard, Limited]

The high-resolution model is ideal for optical spectrum measurement of visible lasers. *0.01 nm can be set in the wavelength range 350 to 600 nm.

Wide measurable level range: -80 to +20 dBm

Wavelength accuracy: ±0.05 nm

Close-in dynamic range: 60 dB

Color analysis function

DUT oriented test apps (APP)

Model and Suffix Code

Model	Suffix Code	Description
AQ6373E		AQ6373E Optical Spectrum Analyzer
Spec code	-10	Standard model
	-20	High resolution model
	-00	Limited model
Built-in light source	-L1	Optical alignment source
Power cord	-D	UL/CSA standard and PSE compliant, 125 V
	-F	VDE/Korean standard, 250 V
	-R	Australian standard, 250 V
	-H	Chinese standard, 250 V
	-Q	British standard, 250 V
	-N	Brazilian standard, 250 V
	-T	Taiwanese standard, 125 V
	-B	Indian standard, 250 V
	-U	IEC Plug Type B, 250 V

Specifications

	Standard (-10)	High resolution (-20)	Limited (-00)
Wavelength range ¹	350 to 1200 nm		
Span ¹	0.5 nm to 850 nm (Full span), 0 nm		
Wavelength accuracy ¹	±0.05 nm (633 nm), ±0.2 nm (400 to 1100 nm) (After wavelength calibration with 633 nm He-Ne laser.)		
Wavelength resolution setting ^{1, 2}	0.02, 0.05, 0.1, 0.2, 0.5, 1, 2, 5 and 10 nm		0.1, 0.2, 0.5, 1, 2 and 5 nm
High wavelength resolution mode ¹	—	0.01 nm (350 to 600 nm)	—
Minimum sampling resolution ¹	0.001 nm		
Number of sampling	101 to 200001, AUTO		
Level sensitivity setting	NORM_HOLD, NORM_AUTO, NORMAL, MID, HIGH1, HIGH2 and HIGH3		NORM_HOLD, NORM_AUTO, NORMAL, MID, HIGH1 and HIGH2
High dynamic mode	SWITCH (Sensitivity: MID, HIGH1-3)		SWITCH (Sensitivity: MID, HIGH1-2)
Level sensitivity ³	-80 dBm (500 to 1000 nm), -60 dBm (400 to 500 nm, 1000 to 1100 nm) (Typical, Resolution setting: ≥0.2 nm, Averaging: 10 times, Sensitivity: HIGH3)		-70 dBm (500 to 1000 nm), -50 dBm (400 to 500 nm, 1000 to 1100 nm) (Typical, Resolution setting: ≥0.2 nm, Averaging: 10 times, Sensitivity: HIGH2)
Maximum safe input power ³	+20 dBm (550 to 1100 nm), +10 dBm (400 to 550 nm) (Total input power)		
Level accuracy ³	±1.0 dB (850 nm, Input level: -20 dBm, Resolution setting: ≥0.2 nm, Sensitivity: MID, HIGH1-3, SMF [MFD5 μm@850 nm, NA0.14]) *Excludes HIGH 3 for limited model		
Level linearity ³	±0.2 dB (Input level: -40 to 0 dBm, Sensitivity: HIGH1-3) *Excludes HIGH 3 for limited model		
Dynamic range ^{1, 5}	60 dB (Peak ±0.5 nm, Resolution: 0.02 nm, 633 nm)		45 dB (Peak ±0.5 nm, Resolution: 0.1 nm, 633 nm)
Applicable fiber	SM, MM (GI 50/125, GI 62.5/125), Large core: up to 800 μm)		
Optical connector	FC type (Optical input and Calibration output)		
Built-in calibration light source	Optical alignment source (For optical alignment. Wavelength reference is not equipped.)		
Sweep time ^{1, 4}	NORM_AUTO: 0.5 s, NORMAL: 1 s, MID: 2 s, HIGH1: 5 s, HIGH2: 20 s, HIGH3: 75 s *Excludes HIGH 3 for limited model		
Warm-up time	Minimum 1 hour (After warming up, optical alignment adjustment with built-in light source required.)		

Performance and functions can be limited by type of used fiber. The specifications are only guaranteed when a single mode fiber in which light travels in single mode at measured wavelength is used. In case that measured wavelength is less than the cut-off wavelength of the used fiber, or a multimode fiber is used, a measured spectrum may be inaccurate due to a speckle noise. Please be cautious especially when measuring high coherency sources like gas laser and Laser diode.

¹: Horizontal scale: Wavelength display mode. ²: Actual wavelength resolution values according to a measured wavelength. Actual resolution at 10 nm resolution setting is about 8 nm at most.

³: Vertical scale: Absolute power display mode. ⁴: High dynamic mode: OFF, number of sampling: 1001, average number: 1, span: ≤ 100 nm excluding 450 to 470 nm and 690 to 700 nm.

⁵: High dynamic mode: SWITCH, fiber core size: SMALL.

Wide Range OSA Covering from Visible Light to Communications Wavelength

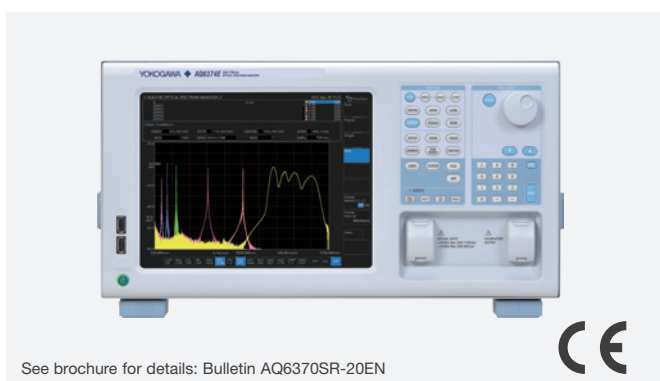

See brochure for details: Bulletin AQ6370SR-20EN

Features

Wavelength range: 350 to 1750 nm

8 wavelength resolution settings: 0.05 to 10 nm

Enables the user to choose the best value according to the device/system under test.

Wide measurable level range: -80 to +20 dBm

Suitable to measure high power as well as low power sources used in different fields of application.

Wavelength accuracy: ± 0.05 nm

The wavelength accuracy can be maintained by the calibration using the built-in reference light source or an external light source including HeNe laser and Argon light source.

Close-in dynamic range: 60 dB

Color analysis function

Purge feature

DUT oriented test apps (APP)

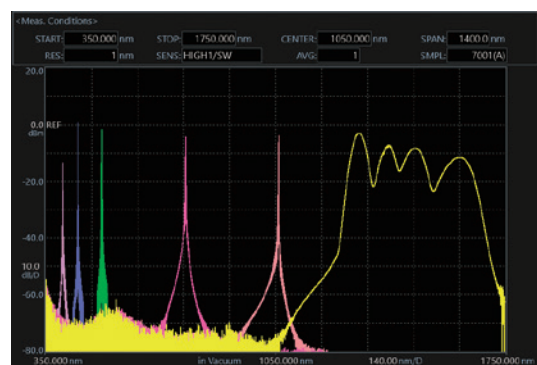

Measurement example of lasers and broad band light source (5 FP-LDs and SLD light source)

Specifications

Wavelength range ¹	350 to 1750 nm
Span ¹	0.5 nm to 1400 nm (Full span), and 0 nm
Wavelength accuracy ^{1, 2, 5}	± 0.05 nm (633 nm) (After wavelength calibration with 633 nm He-Ne laser.), ± 0.05 nm (1523 nm), ± 0.20 nm (Full range)
Wavelength repeatability ^{1, 2, 5}	± 0.015 nm (1 min.)
Wavelength resolution setting ^{1, 2}	0.05, 0.1, 0.2, 0.5, 1, 2, 5, 10 nm
Minimum sampling resolution ¹	0.002 nm
Number of sampling	101 to 200001, AUTO
Level sensitivity setting	NORM_HOLD, NORM_AUTO, NORMAL, MID, HIGH1, HIGH2 and HIGH3
High dynamic mode	SWITCH (Sensitivity: MID, HIGH1-3)
Level sensitivity ^{2, 3, 6}	-80 dBm (900 to 1600 nm), -70 dBm (400 to 900 nm) (Sensitivity: HIGH3)
Maximum safe input power ^{2, 3}	+20 dBm (550 to 1750 nm), +10 dBm (400 to 550 nm) (Total input power)
Level accuracy ^{2, 3, 4}	± 1.0 dB (1550 nm, Input level: -20 dBm, Sensitivity: HIGH1-3)
Level linearity ^{2, 3}	± 0.2 dB (Input level: -40 to 0 dBm, Sensitivity: HIGH1-3)
Polarization dependence ^{2, 3, 4}	± 0.15 dB (1550 nm)
Dynamic range ^{1, 2, 8}	60 dB (Peak ± 1.0 nm, Resolution: 0.05 nm, 633 nm/1523 nm)
Applicable fiber	SM (9.5/125), MM (GI 50/125, GI 62.5/125, Large core: up to 800 μ m)
Optical connector	Optical input: AQ9447 (□□) Connector adapter (option) required. Calibration output: AQ9441 (□□) Connector adapter (option) required. (□□): Connector type FC or SC
Built-in calibration light source	Wavelength reference source (For optical alignment and wavelength calibration)
Sweep time ^{1, 6, 7}	NORM_AUTO: 0.5 s, NORMAL: 1 s, MID: 2 s, HIGH1: 5 s
Warm-up time	Minimum 1 hour (After warming up, optical alignment adjustment with built-in light source required.)

*1: Horizontal scale: Wavelength display mode. *2: With 9.5/125 μ m single mode fiber, after optical alignment with built-in reference light source, when the purge gas is not used.
*3: Vertical scale: Absolute power display mode, resolution setting: ≥ 0.2 nm *4: With 9.5/125 μ m single mode fiber (B1.1 type defined on IEC60793-2, PC polished, mode field diameter: 9.5 μ m, NA: 0.104 to 0.107). *5: Resolution setting: 0.05 nm *6: Pulse light measurement mode: OFF. *7: Span: ≤ 100 nm (excluding 570 to 580 nm and 900 to 1080 nm), number of sampling: 1001, average number: 1. *8: High dynamic mode: SWITCH, fiber core size: SMALL

Model and Suffix Code

Model	Suffix Code	Description	
AQ6374E		AQ6374E Optical Spectrum Analyzer	
Spec code	-10	Standard model	
Built-in light source	-L1	Wavelength reference source	
Power cord	-D	UL/CSA standard and PSE compliant, 125 V	
	-F	VDE/Korean standard, 250 V	
	-R	Australian standard, 250 V	
	-H	Chinese standard, 250 V	
	-Q	British standard, 250 V	
	-N	Brazilian standard, 250 V	
	-T	Taiwanese standard, 125 V	
	-B	Indian standard, 250 V	
	-U	IEC Plug Type B, 250 V	
Factory installed options	/FC	AQ9447 (FC) Connector Adapter	For Optical Input
	/SC	AQ9447 (SC) Connector Adapter	
	/RFC	AQ9441 (FC) Connector Adapter	For Calibration Output
	/RSC	AQ9441 (SC) Connector Adapter	

The Long Wavelength OSA Covering SWIR Region

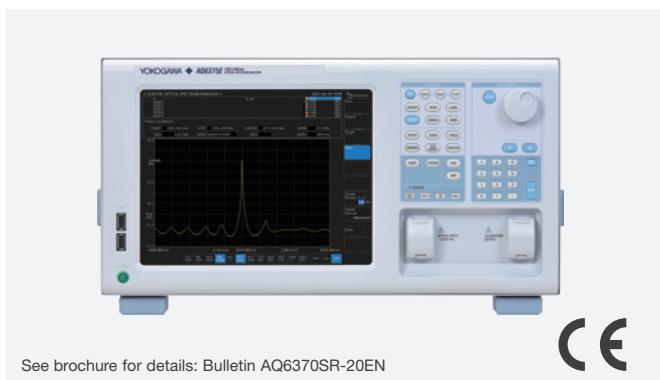

See brochure for details: Bulletin AQ6370SR-20EN

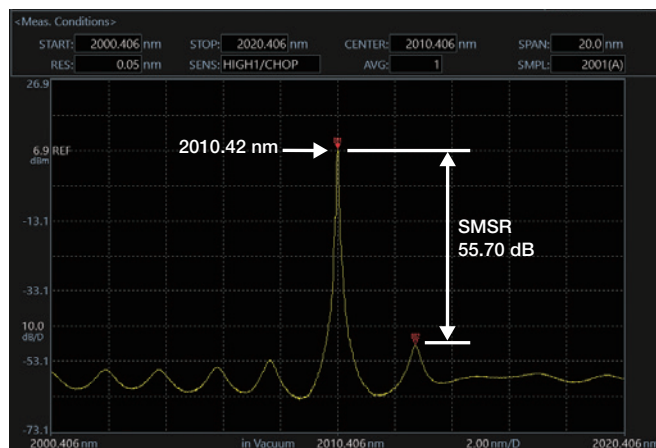

Measurement example of 2010 nm DFB-LD
(Res: 0.05 nm, Span: 20 nm)

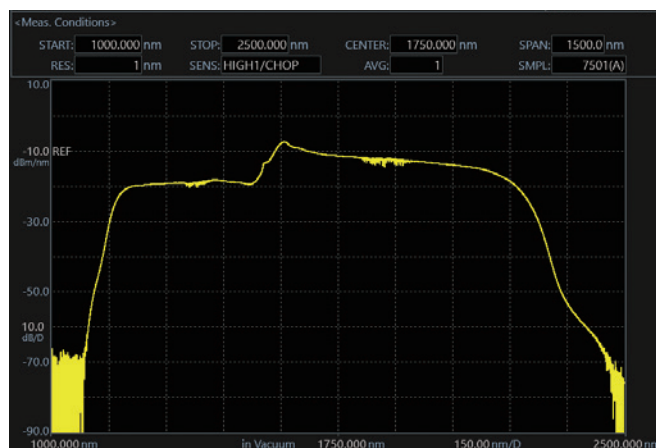

Measurement example of 2 μm supercontinuum light source
(by use of Extended model)

Features

Three model lineups for various applications

In addition to the Standard model with high measurement performance, the lineup includes the Extended model for measuring broad band light sources and the Limited model for production use.

Wavelength range: 1000 to 2500 nm*

*for Extended model (-20)

6 wavelength resolution settings: 0.05 to 2 nm*

Enables the user to choose the best value according to the device/system under test.

*4 res. settings for Limited model (-01)

Wide measurable level range: -70 to +20 dBm

Suitable to measure high power as well as low power sources to suit a wide variety of applications. Sensitivity: HIGH1-3* are only high dynamic mode.

*HIGH1-2 for Limited model (-01)

Wavelength accuracy: ±0.05 nm

Easily maintained due to the built-in Calibration Function and wavelength reference source.

Close-in dynamic range: 55 dB

Purge feature

DUT oriented test apps (APP)

Specifications

	Standard (-10)	Extended (-20)	Limited (-01)
Wavelength range ¹	1200 to 2400 nm	1000 to 2500 nm	1200 to 2400 nm
Span ¹	0.5 nm to 1200 nm (Full span), 0 nm	0.5 nm to 1500 nm (Full span), 0 nm	0.5 nm to 1200 nm (Full span), 0 nm
Wavelength accuracy ^{1, 2, 5}	±0.05 nm (1520 to 1580 nm), ±0.1 nm (1580 to 1620 nm), ±0.5 nm (Full range)		±0.1 nm (1520 to 1620 nm), ±0.5 nm (Full Range)
Wavelength repeatability ^{1, 2}	±0.015 nm (1 min.)		
Wavelength resolution setting ^{1, 2}	0.05, 0.1, 0.2, 0.5, 1 and 2 nm		0.1, 0.2, 0.5 and 1 nm
Minimum sampling resolution ¹	0.002 nm		
Number of sampling	101 to 200001, AUTO		
Level sensitivity setting	NORM_HOLD, NORM_AUTO, NORMAL, MID, HIGH1, HIGH2 and HIGH3 (Only High dynamic mode (/CHOP) in HIGH1-3)		NORM_HOLD, NORM_AUTO, NORMAL, MID, HIGH1 and HIGH2 (Only High dynamic mode (/CHOP) in HIGH1-2)
Level sensitivity ^{2, 3, 6}	-70 dBm (1800 to 2200 nm), -67 dBm (1500 to 1800 nm, 2200 to 2400 nm), -62 dBm (1300 to 1500 nm) (Sensitivity: HIGH3)		-65 dBm (1800 to 2200 nm), -62 dBm (1500 to 1800 nm, 2200 to 2400 nm), -57 dBm (1300 to 1500 nm) (Sensitivity: HIGH2)
Maximum input power ^{2, 3}	+20 dBm (Per channel, Full wavelength range)		
Maximum safe input power ^{2, 3}	+25 dBm (Total input power)		
Level accuracy ^{2, 3, 4, 8}	±1.0 dB (1550 nm, Input level: -20 dBm, Sensitivity: MID, HIGH1-3)		±1.0 dB (1550 nm, Input level: -20 dBm, Sensitivity: MID, HIGH1-2)
Level linearity ^{2, 3}	±0.05 dB (Input level: -30 to +10 dBm, Sensitivity: HIGH1-3)		±0.05 dB (Input level: -30 to +10 dBm, Sensitivity: HIGH1-2)
Polarization dependence ^{2, 3, 8}	±0.1 dB (1550 nm)		
Dynamic range ^{1, 2}	45 dB (Peak ±0.4 nm, Resolution: 0.05 nm), 55 dB (Peak ±0.8 nm, Resolution: 0.05 nm) (1523 nm, Sensitivity: HIGH1 to 3)		40 dB (Peak ±0.5 nm, Resolution: 0.1 nm) (1523 nm, Sensitivity: HIGH1-2)
Applicable fiber	SM (9.5/125), MM (GI 50/125, GI 62.5/125, Large core: up to 400 μm)		
Optical connector	Type FC (Optical input, Calibration output)		
Built-in calibration light source	Wavelength reference source (For optical alignment and wavelength calibration)		
Sweep time ^{1, 6, 7}	NORM_AUTO: 0.5 s, NORMAL: 1 s, MID: 2 s, HIGH1: 20 s		
Warm-up time	Minimum 1 hour (After warming up, optical alignment adjustment with built-in light source required.)		

*1: Horizontal scale: Wavelength display mode.

*2: With 9.5/125 μm single mode fiber, after 2 hours of warm-up, after optical alignment with built-in reference light source, when the purge gas is not used.

*3: Vertical scale: Absolute power display mode, Resolution setting: ≥ 0.1 nm.

*4: With 9.5/125 μm single mode fiber (B1.1 type defined on IEC60793-2, PC polished, mode field).

*5: After wavelength calibration with built-in reference light source, Sampling resolution: ≤ 0.003 nm, Sensitivity: MID, HIGH1-3. (MID, HIGH1, 2 for Limited model)

*6: Pulse light measurement mode: OFF.

*7: Span: ≤ 100 nm, Number of sampling: 1001, Average number: 1.

*8: Temperature condition changes to 23 ±3°C at 0.1 nm resolution setting.

Model and Suffix Code

Model	Suffix Code	Description
AQ6375E		AQ6375E Optical Spectrum Analyzer
Spec code	-10	Standard model
	-20	Extended model
	-01	Limited model
Built-in light source	-L1	Wavelength reference source
Power cord	-D	UL/CSA standard and PSE compliant, 125 V
	-F	VDE/Korean standard, 250 V
	-R	Australian standard, 250 V
	-H	Chinese standard, 250 V
	-Q	British standard, 250 V
	-N	Brazilian standard, 250 V
	-T	Taiwanese standard, 125 V
	-B	Indian standard, 250 V
	-U	IEC Plug Type B, 250 V

The Long Wavelength OSA Covering SWIR and MWIR Region



See brochure for details: Bulletin AQ6370SR-20EN

Optical Measuring Instruments

Features

Wavelength range: 1500 to 3400 nm

5 wavelength resolution settings: 0.1 to 2 nm

Enables the user to choose the best value according to the device/system under test.

Wide measurable level range: -65 to +13 dBm

Suitable to measure high power as well as low power sources used in different fields of application. Sensitivity: HIGH1-3 are only high dynamic mode.

Wavelength accuracy: ±0.5 nm

Easily maintained due to the built-in Calibration Function and wavelength reference source.

Close-in dynamic range: 55 dB

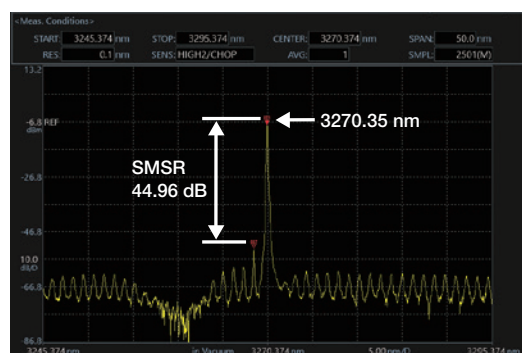

Measurement example of 3270 nm DFB-LD (Res: 0.1 nm, Span: 50 nm)

Horizontal scale also in Wave Number (cm⁻¹)

In addition to the commonly-used scales in wavelength (nm) and frequency (THz).

Purge feature

Built-in cut filter for high order diffracted light

The AQ6376E automatically sets an internal optical filter according to the measurement wavelength range. The filter drastically reduces the influence of high order diffracted light on the measurement.

DUT oriented test apps (APP)

Specifications

Wavelength range ¹	1500 to 3400 nm
Span ¹	0.5 nm to 1900 nm (Full span), 0 nm
Wavelength accuracy ^{1, 2, 5}	±0.5 nm (Full range)
Wavelength repeatability ^{1, 2}	±0.015 nm (1 min.)
Wavelength resolution setting ^{1, 2}	0.1, 0.2, 0.5, 1 and 2 nm
Minimum sampling resolution ¹	0.003 nm
Number of sampling	101 to 200001, AUTO
Level sensitivity setting	NORM_HOLD, NORM_AUTO, NORMAL, MID, HIGH1, HIGH2 and HIGH3 (Only High dynamic mode (/CHOP) in HIGH1-3)
Level sensitivity ^{2, 3, 4, 6}	-65 dBm (1500 to 2200 nm), -55 dBm (2200 to 3200 nm), -50 dBm (3200 to 3400 nm) (Sensitivity: HIGH3)
Maximum input power ^{2, 3}	+13 dBm (Per channel, Full wavelength range)
Maximum safe input power ^{2, 3}	+20 dBm (Total input power)
Level accuracy ^{2, 3, 4, 8}	±1.0 dB (1550 nm, input level: -20 dBm, Sensitivity: MID, HIGH1-3)
Level linearity ^{2, 3}	±0.2 dB (Input level: -30 to +10 dBm, Sensitivity: HIGH1-3)
Dynamic range ^{1, 2}	40 dB (Peak ±1 nm, Resolution: 0.1 nm), 55 dB (Peak ±2 nm, Resolution: 0.1 nm) (1523 nm, Sensitivity: HIGH1-3)
Applicable fiber	SM (9.5/125), MM (GI 50/125, GI 62.5/125, Large core: up to 400 μm)
Optical connector	Type FC (Optical input, Calibration output)
Built-in calibration light source	Wavelength reference source (For optical alignment and wavelength calibration)
Sweep time ^{1, 6, 7}	NORM_AUTO: 0.5 s, NORMAL: 1 s, MID: 2 s, HIGH1: 20 s
Warm-up time	Minimum 1 hour (After warming up, optical alignment adjustment with built-in light source required.)

*1: Horizontal scale: Wavelength display mode.

*2: With 9.5/125 μm single mode fiber, after 2 hours of warm-up, after optical alignment with built-in reference light source, when the purge gas is not used.

*3: Vertical scale: Absolute power display mode, Resolution setting: ≥ 0.2 nm.

*4: With 9.5/125 μm single mode fiber (B1.1 type defined on IEC60793-2, PC polished, mode field).

*5: After wavelength calibration with built-in reference light source, Sampling resolution: ≤ 0.003 nm, Sensitivity: MID, HIGH1-3.

*6: Pulse light measurement mode: OFF.

*7: Span: ≤ 100 nm, Number of sampling: 1001, Average number: 1.

*8: Temperature condition changes to 23 ±3°C at 0.1 nm resolution setting.

Model and Suffix Code

Model	Suffix Code	Description
AQ6376E		AQ6376E Optical Spectrum Analyzer
Spec code	-10	Standard model
Built-in light source	-L1	Wavelength reference source
Power cord	-D	UL/CSA standard and PSE compliant, 125 V
	-F	VDE/Korean standard, 250 V
	-R	Australian standard, 250 V
	-H	Chinese standard, 250 V
	-Q	British standard, 250 V
	-N	Brazilian standard, 250 V
	-T	Taiwanese standard, 125 V
	-B	Indian standard, 250 V
	-U	IEC Plug Type B, 250 V

The Long Wavelength OSA Covering MWIR Region

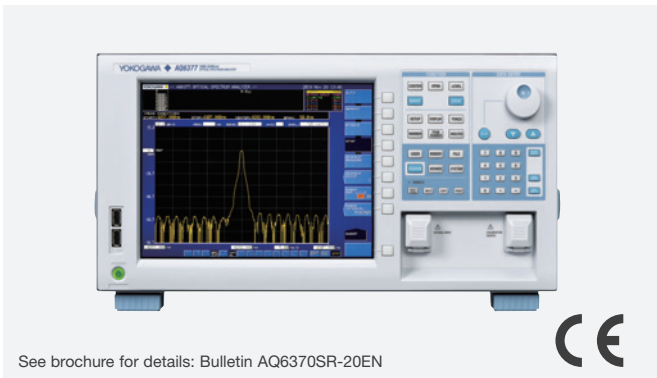

See brochure for details: Bulletin AQ6370SR-20EN

Features

Wavelength range: 1900 to 5500 nm

5 wavelength resolution settings: 0.2 to 5 nm

Enables the user to choose the best value according to the device/system under test.

Wide measurable level range: -60 to +13 dBm

Suitable to measure high power as well as low power sources used in different fields of application. Sensitivity: HIGH1-3 are only high dynamic mode.

Wavelength accuracy: ±0.5 nm

Easily maintained due to the built-in Calibration Function and wavelength reference source.

Close-in dynamic range: 50 dB

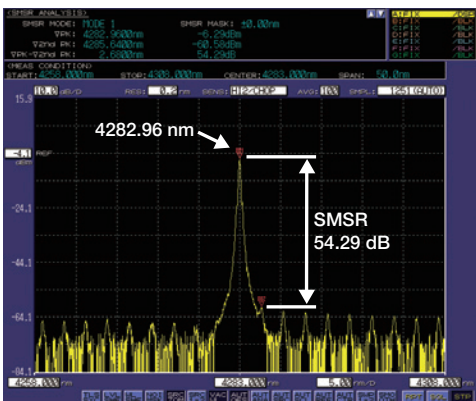

Measurement example of 4.3 μm DFB laser (Res: 0.2 nm, Span: 50 nm)

Horizontal scale also in Wave Number (cm⁻¹)

In addition to the commonly-used scales in wavelength (nm) and frequency (THz).

Purge feature

Built-in cut filter for high order diffracted light

The AQ6377 automatically sets an internal optical filter according to the measurement wavelength range. The filter drastically reduces the influence of high order diffracted light on the measurement.

Applications

Analyzing mid-infrared laser

- Interband cascade laser (ICL)
- Quantum cascade laser (QCL)
- Fiber laser
- Supercontinuum light sources (SC)

Specifications

Wavelength range ^{*1}	1900 to 5500 nm
Span ^{*1}	1.0 nm to 3600 nm (Full span), 0 nm
Wavelength accuracy ^{*1, *2}	±0.50 nm (Full range)
Wavelength resolution setting ^{*1, *2}	0.2, 0.5, 1, 2 and 5 nm
Minimum sampling resolution ^{*1}	0.010 nm
Number of sampling	101 to 50001, AUTO
Level sensitivity setting	NORM_HOLD, NORM_AUTO, NORMAL, MID, HIGH1, HIGH2 and HIGH3 (Only High dynamic mode (/CHOP) in HIGH1-3)
Level sensitivity ^{*3, *5, *6}	-40 dBm (1900 to 2200 nm), -50 dBm (2200 to 2900 nm), -60 dBm (2900 to 4500 nm) (Sensitivity: HIGH3)
Maximum input power ^{*3, *5, *6}	+13 dBm (Per channel, full wavelength range)
Maximum safe input power ^{*3, *5, *6}	+20 dBm (Total input power)
Level accuracy ^{*3, *4, *5, *6}	±2.0 dB (2000 nm, input level: -10 dBm, Sensitivity: HIGH1-3, single mode fiber)
Dynamic range ^{*1, *2, *3}	50 dB (Peak ±5 nm, Resolution: 0.2 nm, Sensitivity: HIGH1-3)
Applicable fiber	SM, MM (Large core: up to 400 μm)
Optical connector	FC type (Optical input and Calibration output)
Built-in calibration light source	Wavelength reference source (For optical alignment and wavelength calibration)
Sweep time ^{*1, *6, *7}	NORM_AUTO: 0.5 s, NORMAL: 1 s, MID: 2 s, HIGH1: 20 s
Warm-up time	Minimum 1 hour (After warming up, optical alignment adjustment with built-in light source required.)

*1: Horizontal scale: Wavelength display mode.

*2: Single mode fiber, after 2 hours of warm-up, after optical alignment with built-in reference light source, when the purge gas is not used.

*3: Typical.

*4: Difference from Yokogawa's original standard device, with single mode fiber for 2 μm range.

*5: Vertical scale: Absolute power display mode, Resolution setting: ≥ 0.5 nm.

*6: Pulse light measurement mode: OFF.

*7: Span: ≤ 100 nm (excluding 2200 to 2220 nm and 3900 to 3940 nm), number of sampling: 1001, average number: 1.

Model and Suffix Code

Model	Suffix Code	Description
AQ6377		AQ6377 Optical Spectrum Analyzer
Spec code	-10	Standard model
Built-in light source	-L1	Wavelength reference source
Power cord	-D	UL/CSA standard and PSE compliant, 125 V
	-F	VDE/Korean standard, 250 V
	-R	Australian standard, 250 V
	-H	Chinese standard, 250 V
	-Q	British standard, 250 V
	-N	Brazilian standard, 250 V
	-T	Taiwanese standard, 125 V
	-B	Indian standard, 250 V
	-U	IEC Plug Type B, 250 V

Our Fastest OSA Optimized for Optical Device Manufacturing

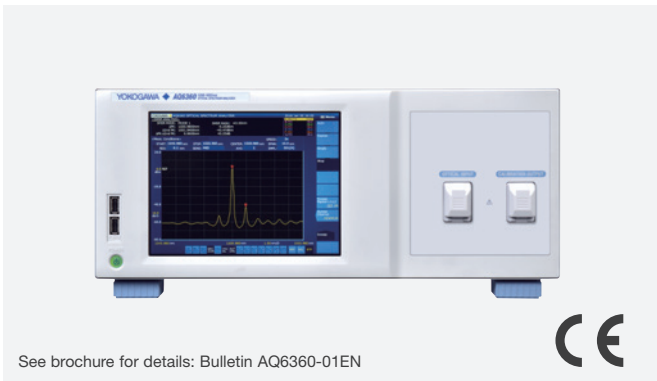

See brochure for details: Bulletin AQ6360-01EN

Features

Ideal performance for manufacturing tests

The AQ6360 satisfies the typical measurement needs of industrial manufacturing of telecom devices such as lasers, optical transceivers and optical amplifiers.

- Wavelength range: 1200 to 1650 nm
- Wavelength resolution: 0.1 to 2 nm
- High wavelength accuracy: ± 0.02 nm
- High dynamic range: 55 dB
- Wide measurement range: +20 to -80 dBm

Sweep up to two times faster

The AQ6360 can sweep up two times faster than our models designed for R&D purposes.

Free space optical input

The free space optical input structure is the most effective to guarantee high coupling efficiency and measurement repeatability.

Dual-purpose

Accepts both single-mode and multimode optical fibers

Versatile

Accepts both flat and angle polished connectors

Worry free

Damage proof internal input connector

Maintenance-free

No internal fiber to clean

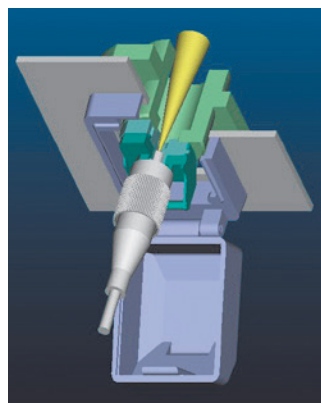

Optical input structure

Built-in wavelength reference source (Factory option)

Space saving 4U height (1U lower than AQ6370 Series)



AQ6370E

AQ6360

AQ6370 series compatible operation

The AQ6360 inherits the screen and menu layout from our OSA lineup, which is recognized by thousands of users all over the world as the most intuitive and easy-to-use.

Multi-touch touchscreen

Tap, drag, pinch in and pinch out. The high resolution, responsive 8.4-inch multi-touch capacitive touchscreen makes the operation of the instrument simple and intuitive.



Built-in analysis functions to increase productivity

More than ten data analysis functions are available, including WDM (OSNR), SMSR, DFB-LD, EDFA, and Spectral width.

Ready for remote operation

Ethernet and GPIB remote interfaces

The AQ6360 is equipped with GP-IB, and Ethernet interfaces for remote access and for building automated test systems.

AQ6370E compatible remote commands

It is compatible with both AQ6370E and AQ6317 commands for easy programming.

Applications

LD chip and TOSA

The AQ6360 delivers improvements in measurement throughput via a multimode fiber for free space laser beams from wafers, LD chip, TO CAN and TOSA measurements. This is due to the free space input structure of the OSA which accepts multimode fibers without high insertion loss, which occurs when multimode and single mode fibers are mismatched.

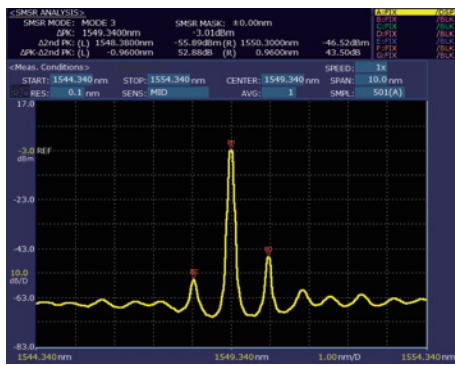
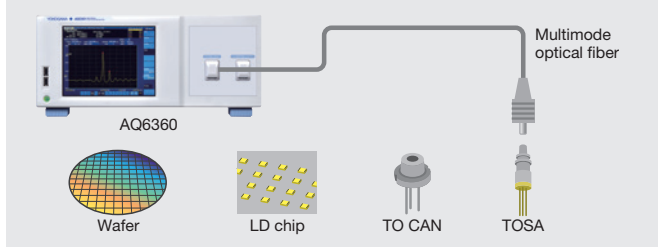

The side mode suppression ratio (SMSR) of laser can be measured quickly and accurately.

Optical amplifier

The AQ6360 has an automated function to easily calculate the Erbium Doped Fiber Amplifier Noise Figure under the name “EDFA-NF”. A typical measurement setup for amplifier testing consists of a set of multiplexed lasers, an attenuator for tuning the laser power level, an optical spectrum analyzer.

The OSA takes two high-resolution spectrums. One trace is taken before amplification and one after amplification. From the obtained spectrums, the EDFA-NF Analysis Function automatically detects the laser peaks, extracts the required measurement values, performs the calculations and displays a table with the values of GAIN and NF of the DUT.

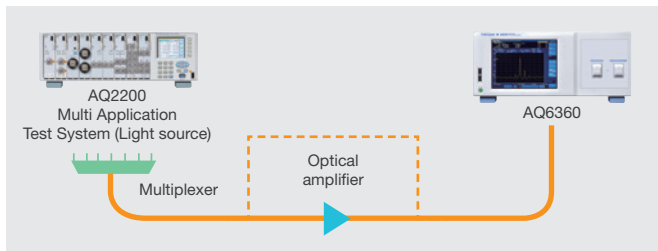

The typical experimental setup for optical amplifier testing



The automated routine for the analysis of optical amplifiers provides a table with their relevant parameters

Specifications

Applicable fiber	SM (9.5/125), MM (GI 50/125, GI 62.5/125)
Wavelength range ¹	1200 to 1650 nm
Span ¹	0.1 to 450 nm (entire wavelength range), and 0 nm
Wavelength accuracy ^{1, 2, 4}	±0.02 nm (1520 to 1580 nm), ±0.04 nm (1580 to 1620 nm), ±0.10 nm (1200 to 1650 nm)
Wavelength linearity ^{1, 2, 4}	±0.02 nm (1520 to 1580 nm, 1580 to 1620 nm)
Wavelength repeatability ^{1, 2}	±0.01 nm (1 min.)
Wavelength resolution setting ^{1, 2}	0.1, 0.2, 0.5, 1 and 2 nm
Wavelength resolution bandwidth accuracy ^{1, 2}	±5%
Minimum sampling resolution ¹	0.001 nm
Number of sampling points	101 to 50001, AUTO
Level sensitivity setting	NORM_HOLD, NORM_AUTO, NORMAL, MID, HIGH1, and HIGH2
Level sensitivity ^{2, 3}	-80 dBm (1300 to 1620 nm, sensitivity: HIGH2, resolution: 0.1 nm)
Maximum input power ²	+20 dBm (Input power per set wavelength resolution)
Maximum safe input power ²	+25 dBm (Total input power)
Level accuracy ^{2, 3}	±0.5 dB (1310/1550 nm, -20 dBm, sensitivity: MID, HIGH1-2)
Level linearity ²	±0.1 dB (Input level: -50 to +10 dBm, sensitivity: MID, HIGH1-2)
Level flatness ²	±0.2 dB (1520 to 1580 nm, 1580 to 1620 nm)
Polarization dependence ²	±0.1 dB (1550 nm)
Dynamic range ^{1, 2}	55 dB (Peak ±0.4 nm), 40 dB (Peak ±0.2 nm) (Resolution: 0.1 nm)
Optical return loss ⁵	35 dB (Typ., with angled-PC connector)
Optical input connector	FC or SC
Built-in calibration light source (option)	Wavelength reference source (For wavelength calibration)
Sweep time ^{1, 6}	NORM_AUTO: 0.2 s, NORMAL: 0.5 s, MID: 1 s, HIGH1: 2.5 s, HIGH2: 10 s
Warm-up time	Minimum 1 hour (After warm-up, the wavelength calibration is required.)

¹Typical or "typ." in this document means "Typical value", which is for reference, not guaranteed specification.
¹: Horizontal scale: In the wavelength display mode
²: With 9.5/125 μm single mode fiber with a PC type connector, after 1 hour of warm-up, sampling resolution ≤0.05 nm
³: With 9.5/125 μm single mode fiber (B1.1 type defined on IEC60793-2, PC polished, mode field diameter: 9.5 μm, NA: 0.104 to 0.107)
⁴: After wavelength calibration with built-in reference light source or a single longitudinal mode laser (wavelength 1520 to 1560 nm, peak level ≥-20 dBm and absolute wavelength accuracy ±0.003 nm).
⁵: With Yokogawa's master single mode fiber with an angled-PC connector. Typical 15 dB with PC connector.
⁶: Span: ≤100 nm, number of sampling: 1001, average number: 1

Model and Suffix Code

Model	Suffix Code	Description
AQ6360		AQ6360 Optical Spectrum Analyzer
Spec. code	-10	Standard model
Optical input connector	-FC	AQ9447 (FC) Connector Adapter
	-SC	AQ9447 (SC) Connector Adapter
Display	-D1	Built-in display
Power cord	-D	UL/CSA standard and PSE compliant, 125 V
	-F	VDE/Korean standard, 250 V
	-H	Chinese standard, 250 V
	-Q	British standard, 250 V
	-R	Australian standard, 250 V
	-N	Brazilian standard, 250 V
	-T	Taiwanese standard, 125 V
	-B	Indian standard, 250 V
	-U	IEC Plug Type B, 250 V
Options	Built-in light source	/LFC Wavelength reference source (FC connector) /LSC Wavelength reference source (SC connector)

High Performance and Cost-Effective Optical Wavelength Meter Exceeding the Testing Needs of Optical Devices and Transmission Systems



See brochure for details: Bulletin AQ6150SR-01EN



Increase throughput with high speed measurement

Both models can acquire, analyze and transfer a measurement to a PC within 0.2 seconds. This vastly improves production throughput.

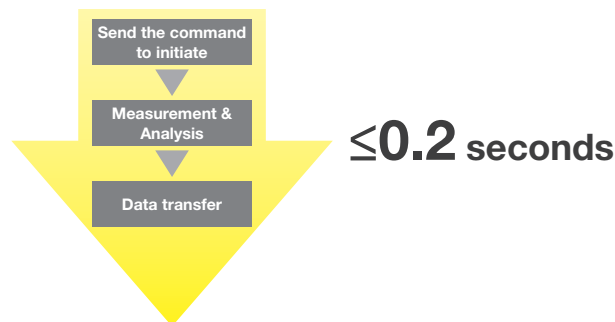

Features

The AQ6150B & AQ6151B optical wavelength meters is an ideal instrument for accurately measuring the optical wavelength of optical devices and systems used in telecommunication applications from 900 to 1700 nm. By employing a Michelson interferometer and a high speed Fast Fourier Transform (FFT) algorithm, the AQ6150 series can measure not only a single wavelength laser signal but also a multiple wavelength laser signal from a DWDM system and Fabry-Perot laser.

- Wavelength Range: 1270 to 1650 nm, 1200 to 1700 nm, 900 to 1700 nm
- Wavelength accuracy: ±0.2 ppm (AQ6151B), ±0.7 ppm (AQ6150B)
- Simultaneous measurement of up to 1024 wavelengths
- Cope with modulated light and optical filter measurement
- Increase throughput with high speed measurement (≤0.2 s)
- Reduce the lifetime ownership costs
- logging data function
- Add WDM (OSNR) analysis
- Abundant functions to increase work efficiency

Various view modes

Other modes: Single wavelength view, Delta wavelength view, Grid view, and List view



Multi wavelength view

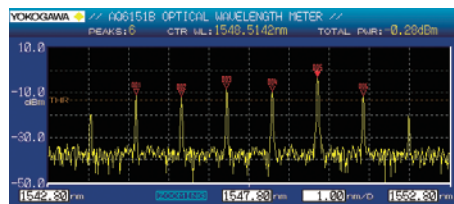

Optical spectrum view

Product Lineup

There are two models in the series. The High Accuracy AQ6151B model offers an accuracy of ±0.2 ppm to meet the most demanding precision requirements. The Standard Accuracy AQ6150B offers a ±0.7 ppm accuracy for applications with less demanding requirements at a more affordable price.

Model		Wavelength	Accuracy	Maximum number of wavelengths	Application
High accuracy model AQ6151B	Standard	1270 to 1650 nm	±0.2 ppm	1024 (Multi-wavelength) 1 (Single-wavelength)	Adjustment, characterization, and inspection of laser chips, tunable lasers, WDM transmission systems, etc.
	Extended	1200 to 1700 nm			
	Wide range	900 to 1700 nm			
Standard model AQ6150B	Standard	1270 to 1650 nm	±0.7 ppm	1024 (Multi-wavelength) 1 (Single-wavelength)	Inspection of DFB-LDs, tunable lasers, optical transceivers. WDM transmission systems
	Extended	1200 to 1700 nm			
	Wide range	900 to 1700 nm			

Applications

WDM transmission systems

- Simultaneous measurement of multi channel and narrow spacing WDM system
- Precise adjustment and inspection of laser sources
- Measurement of modulated signals

Lasers/optical transceivers

- Precise adjustment and inspection of tunable lasers
- Modulated signal measurement of optical transceivers and transponders.
- Measurement of all channels of 25 G and 100 G optical transceivers with WDM technology.

Calibration of test systems

- Calibration of optical spectrum analyzers.
- Calibration of DFB lasers for optical amplifier test system.
- Calibration of tunable lasers for passive component test systems.

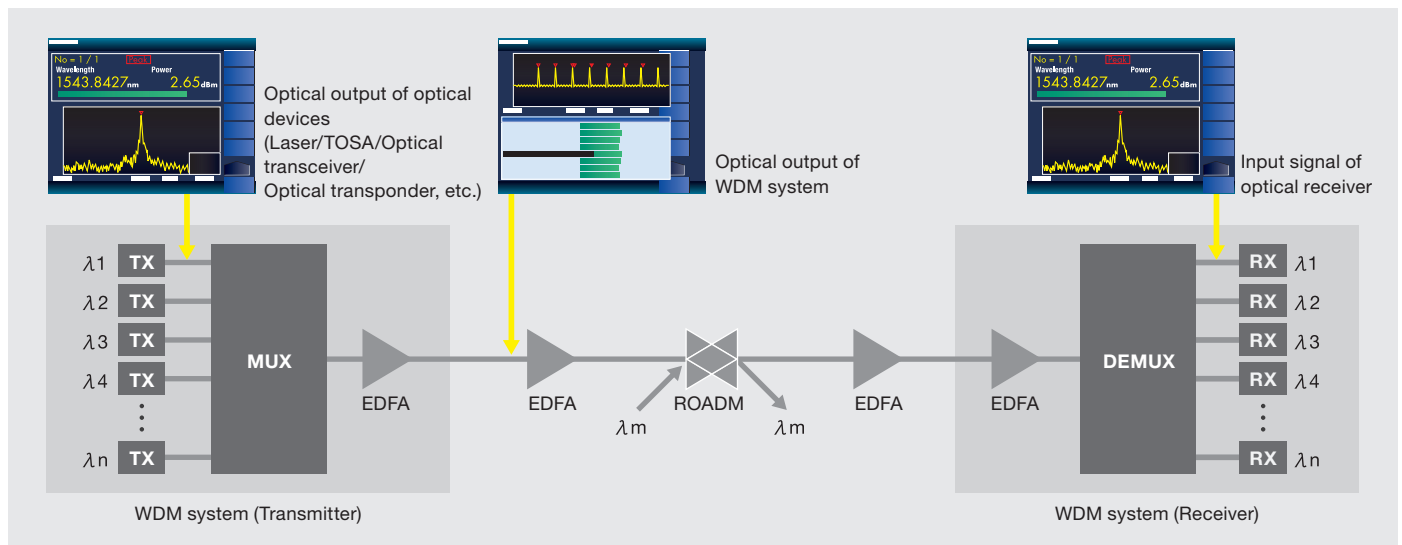

Specifications

Applicable optical fiber	SM (ITU-T G.652)
Wavelength range	1270 to 1650 nm, 1200 to 1700 nm, 900 to 1700 nm
Wavelength accuracy	AQ6150B: ±0.7 ppm (±1 pm at 1550 nm) AQ6151B: ±0.2 ppm (±0.3 pm at 1550 nm)
Min. resolvable separation	5 GHz (40 pm at 1550 nm)
Display resolution (Wavelength)	0.0001 nm
Power accuracy	±0.5 dB (1550 nm, -10 dBm)
Linearity	±0.3 dB (1550 nm, -30 dBm or higher)
Polarization dependency	±0.5 dB (1550 nm)
Display resolution (Power)	0.01 dB
Max. number of wavelengths	1024
Min. input power	-40 dBm (1270 to 1600 nm, single line input) -30 dBm (1600 to 1650 nm, single line input)
Max. input power	+10 dBm (total of all lines)
Safe max. input power	+18 dBm (total of all lines)
Return loss	35 dB
Measurement time	0.2 s or less (single measurement, update rate: Fast)
Display	5.7-inch color LCD (640 × 480 dots)
Data storage	Internal: 256 MB or more, External: USB
Interfaces	GP-IB, ETHERNET, USB, VGA output
Remote control	GP-IB, ETHERNET
Optical connector	FC/PC or SC/PC (AQ9441 Universal adapter)
Dimensions	Approx. 426 (W) × 132 (H) × 450 (D) mm
Mass	Approx. 11 kg

Please refer to the product brochure for details.

Model and Suffix Code

Model	Suffix Code	Description
AQ6150B		AQ6150B Optical Wavelength Meter
AQ6151B		AQ6151B Optical Wavelength Meter
Spec Code	-10	Standard type (1270 to 1650 nm)
	-20	Extended type (1200 to 1700 nm)
	-30	Wide range type (900 to 1700 nm)
Wavelength Detection	-SW	Single-wavelength type
	-MW	Multi-wavelength type
Optical input Connector	-FCC	FC/PC (AQ9441 Universal Adapter)
	-SCC	SC/PC (AQ9441 Universal Adapter)
Power Code	-D	UL/CSA standard and PSE compliant, 125 V
	-F	VDE/Korean standard, 250 V
	-R	Australian standard, 250 V
	-Q	British standard, 250 V
	-H	Chinese standard, 250 V
	-N	Brazilian standard, 250 V
	-T	Taiwanese standard, 125 V
	-B	Indian standard, 250 V
	-U	IEC Plug Type B, 250 V

Build Your Own Test Configurations in Small Footprint

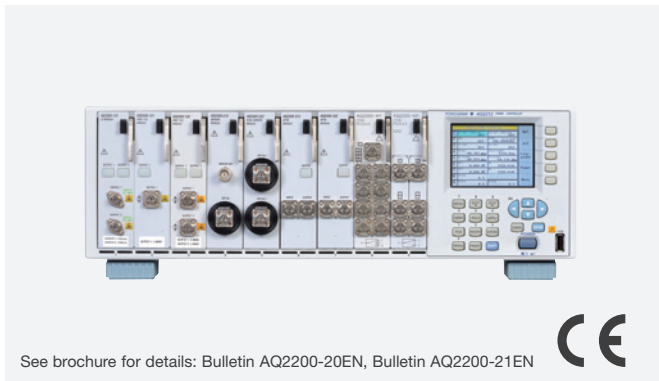

Features

The AQ2200 Multi Application Test System is the ideal system for measuring and evaluating a wide range of optical devices and optical transmitters.

- Flexible and space effective
- Easy-to-View TFT color display
- Remote operation through Ethernet network
- Built-in applications
 - Optical power stability measurement
 - Short-term optical power fluctuation measurement
- Wide variety of plug-in modules
- Hot-swappable modules

Applications

- GE-PON ONU/OLT measurement system
- GE-PON optical three wavelength filter measurement
- Optical amplifier measurement system
- Optical transceiver measurement system
- Multicore fiber loss measurement

Multicore fiber loss measurement

MPO connector adapter, MT connector adapter and ribbon fiber adapter enable the measurement of the multi-fiber output directly. With the optical switch module, a multi-fiber loss measurement system can be easily configured.

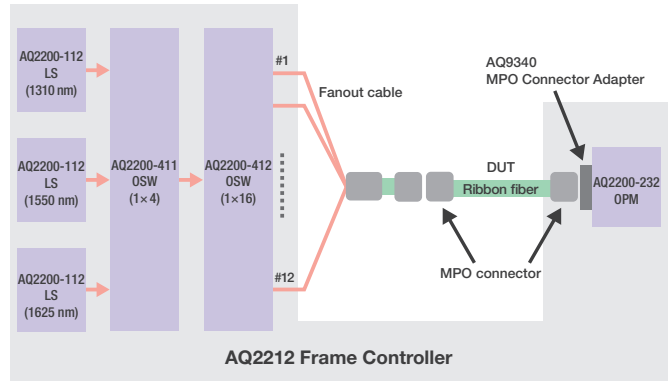

Optical Fiber Amplifier Measurement System

An optical fiber amplifier is an indispensable device for WDM transmission systems. This measurement system characterizes gains and noise figures (NF) of the fiber amplifier by measuring input light to an optical fiber amplifier, which was multiplexed using multiple light sources, as well as amplified output light with an optical spectrum analyzer. A high-power sensor allows for measuring total output power.



AQ6370E Measurement Screen

[Measurement items] Gain, NF, and total output power

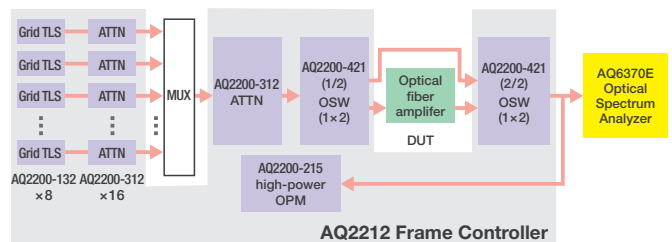

Frame and Module Lineup

Frame controllers

- AQ2211 Frame controller (3 slots for modules)
- AQ2212 Frame controller (9 slots for modules)

Light source modules

- AQ2200-112 LS module (DFB, 1/2 channels)
- AQ2200-131 Grid TLS module (C/L-band, 1 channel)
- AQ2200-132 Grid TLS module (C/L-band, 2 channels)

Sensor modules

- AQ2200-215 Sensor module (+30 dBm, 970-1660 nm, 1-slot)
- AQ2200-212 Sensor module (with analog output port, 800-1700 nm, 1-slot)
- AQ2200-222 Dual sensor module (dual sensor, 800-1700 nm, 1 slot)
- AQ2200-232 Optical sensor head (long wavelength)
- AQ2200-242 Optical sensor head (short wavelength)
- AQ2200-202 Interface module (2 channels)

Optical attenuator modules

- AQ2200-312 ATTN module [w/ Monitor output (optional)] (SMF/MMF, 1-slot)
- AQ2200-332 ATTN module [w/ Built-in monitor power meter] (SMF/MMF, 1-slot)

Optical switch modules

- AQ2200-411 OSW module (1 × 4/1 × 8, SMF/MMF, 1-slot)
- AQ2200-412 OSW module (1 × 16, SMF/MMF, 2-slot)
- AQ2200-421 OSW module (1 × 2/2 × 2, SMF/MMF, 1-slot)

Modules for Optical Transceiver

- AQ2200-642 Transceiver interface module (2-slot)

Adapter for sensor

- AQ9335C Connector adapter (FC, SC, LC, MU)
- AQ9340 MPO connector adapter (12/24-fiber, 16/32-fiber)
- AQ9436C Ribbon fiber adapter (2, 4, 8 and 12 fibers)
- AQ9440C MT connector adapter (2, 4, 8, 12 and 24 fibers)



Specifications

		A2211	AQ2212
Number of slots		3	9
Display*		Color LCD, 320 × 240 dot	
Remote interface	GPIB	IEEE-488 compatible, protocol: IEEE-488.2 compatible	
	Ethernet	IEEE802.3 compatible, connector: RJ-45 × 1, transmission method: Ethernet (100BASE-TX), protocol: TCP/IP	
	USB	USB Rev1.1 compatible, connector: USB type B × 1, protocol: USB-TMC	
External storage interface		USB (USB Rev2.0 compatible, connector: USB type A × 1, applicable device: USB mass storage class flash memory)	
Interlock connector		BNC connector	
Functions	Preset applications	Stability, Logging, Swept, Optical return loss (ORL)	
	Control functions	Macro programming, Multi-user, Remote viewer support	
Operation environment	Ambient temperature	5 to 40°C	
	Ambient humidity	20 to 80% RH (no condensation)	
Storage environment	Ambient temperature	-20 to 60°C	
	Ambient humidity	20 to 80% RH (no condensation)	
Power requirement		100 to 240 Vac, 50/60 Hz	
Power Consumption (including modules)		170 VA	580 VA
Dimension (excluding protrusions)		Approx. 212 (W) × 132.5 (H) × 400 (D) mm	Approx. 425 (W) × 132.5 (H) × 500 (D) mm
Mass		Approx. 6 kg	Approx. 11 kg
Recommended calibration period		1 year (include modules)	

*The LCD may include a few defective pixels (within 0.004% over the total number of pixels including RGB).

Model and Suffix Code

Model	Suffix Code	Description
735101		AQ2211 Frame Controller
735102		AQ2212 Frame Controller
	-D	UL/CSA standard and PSE compliant, rated voltage: 125 V
	-F	VDE/Korean standard, rated voltage: 250 V
	-R	Australian standard, rated voltage: 250 V
	-Q	British standard, rated voltage: 250 V
	-H	Chinese standard, rated voltage: 250 V
	-N	Brazilian standard, rated voltage: 250 V
	-T	Taiwanese standard, rated voltage: 125 V
	-B	Indian standard, rated voltage: 250 V
	-U	IEC Plug Type B, rated voltage: 250 V

Select from Features and Size



...P.82



...P.84



...P.86

● Standard ○ Option

Item	Model	AQ7280 Series	AQ1210 Series	AQ1000
Dimensions (W) × (H) × (D) mm		287 × 210 × 80	210 × 148 × 69	185 × 116 × 56
Weight		2.8 kg	1 kg	660 g
Display	Size	8.4-inch	5.7-inch	5.0-inch
	Touchscreen	●	●	●
Battery operation		15 hours	10 hours	10 hours
Power supply		AC Adapter	USB power adapter	USB power adapter
Wired LAN		○	● ^{*1}	—
Wireless LAN		● ^{*1}	● ^{*1}	○
		File transfer	File transfer & remote control	
Multi-fiber measurement		●	●	—
Smart Mapper		○	●	—
Multi-tasking		●	●	—
Stabilized light source		○	●	●
Power checker ^{*2}		○	○	●
Optical power meter		○	○	—
Visible light source		○	○	○
Fiber surface test ^{*1}	Image display	●	●	—
	Automatic judgment	○	○	—
Auto/Multi-fiber loss test		—	●	—
Schedule function (Monitoring)		○	—	—
Momentary interruption monitoring		○ ^{*3}	—	—

*1 For information on recommended products, please visit: <https://tmi.yokogawa.com/p/otdr/>

*2 Integrated optical power meter

*3 /LAN option and AQ7940 Optical Fiber Monitoring Software are required.



OTDR Model Map

*The dB value is the maximum dynamic range of OTDRs for each target area.

Cable type	Target network			Test application					
	Area*	PON	Installation (measurement of new and dark lines)		Installation/Maintenance (measurement of new and live lines)				
			Model	Wavelength (nm)	Model	Wavelength (nm)			
Single-mode optical fiber cable	Access	32 dB	—	AQ1000	—	1310 1550			
				38 dB	1×32	AQ7282	A	1310 1550	
	1×64	AQ1210	G			1310 1550 1490			
		Access/Metro	42 dB	1×64	AQ1210	A	1310 1550	AQ1210	E
	AQ7283				A	1310 1550	AQ7283	E	1310 1550 1625
	1×128		AQ7283	H	1310 1550 1625	AQ7283	F	1310 1550 1650	
			AQ1215	K	1310 1550 1625 1490	AQ1215	F	1310 1550 1650	
	Metro/Core	46 dB	—	AQ1215	A	1310 1550	AQ1216	F	1310 1550 1650
				AQ7284	A	1310 1550			
	Core	50 dB	—	AQ7285	H	1310 1550 1625			
AQ7285				A	1310 1550				
Multi-mode optical fiber cable	Access/LAN		1×64	AQ1210	D	1310 1550			
	LAN			—	AQ7282	M	850 1300		

Cable type	Target application	Model	Wavelength (nm)	
Single-mode optical fiber cable	Research/Manufacturing	AQ7286	A	1310 1550
		AQ7286	H	1310 1550 1625
		AQ7286	J	1310 1550 1625 1383

Selection by Application and Measurement Performance

Installation of single mode fiber (measurement of new and dark fibers)

The installation models can measure multi trace, including traffic wavelengths (1310/1550 nm) using.

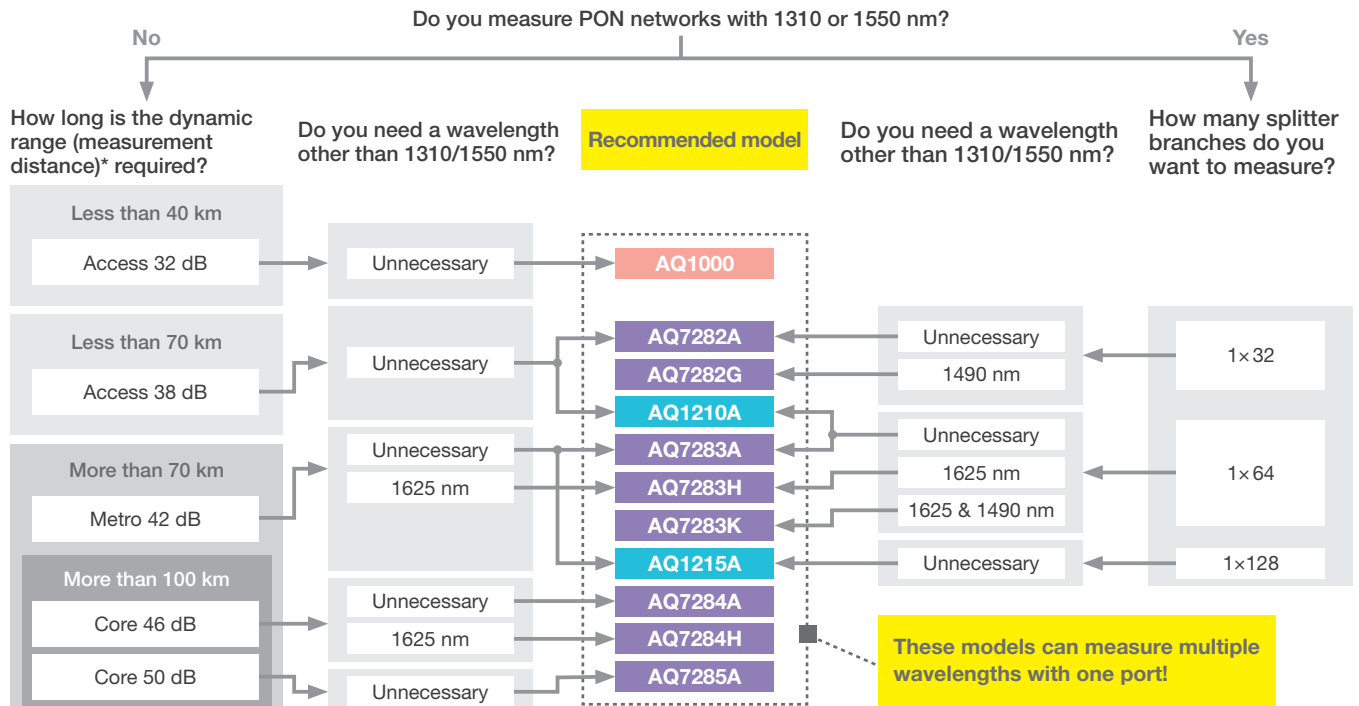

*Use actual measurement distance as guideline (Wavelength: 1550 nm, loss 0.3 dB/km, connection loss)
The dB value is the maximum dynamic range of OTRDs for each target area.

Installation and maintenance of single mode fiber (measurement of new and live lines)

Two separate ports effectively avoids mishaps by offering a dedicated port for the traffic wavelength and a second port for the (16xx nm) maintenance wavelength with built-in cut filter to prevent interference with the traffic wavelength.

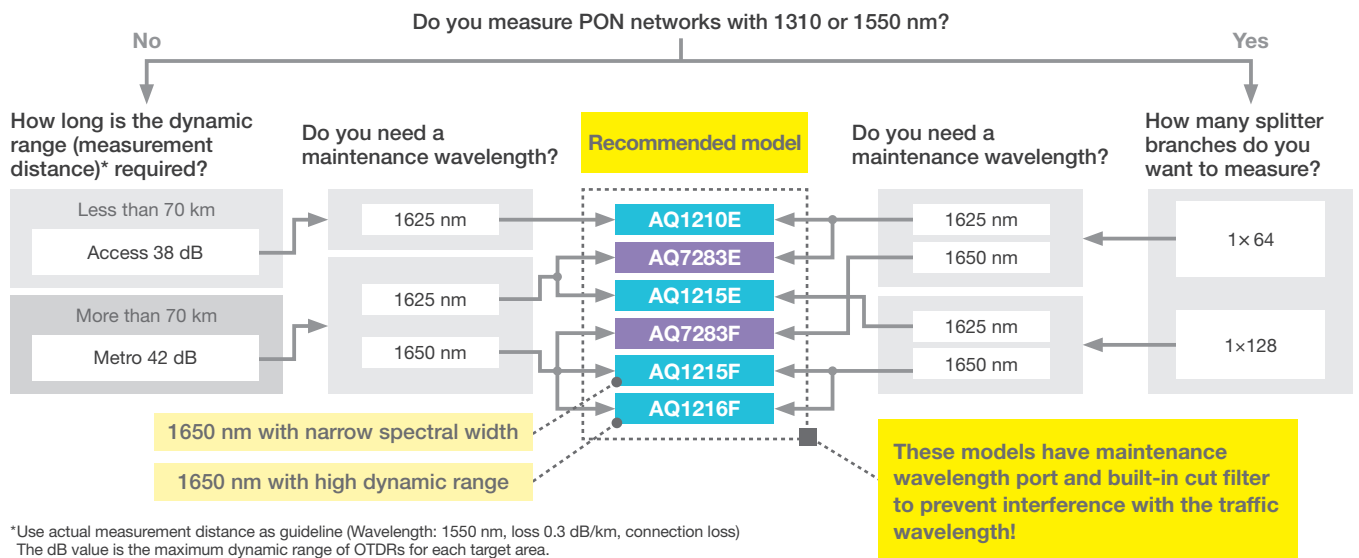

*Use actual measurement distance as guideline (Wavelength: 1550 nm, loss 0.3 dB/km, connection loss)
The dB value is the maximum dynamic range of OTRDs for each target area.

Installation of multimode fiber

Recommended model

AQ7282M

AQ1210D

R&D and Manufacturing

Recommended model

AQ7286A

AQ7286H

AQ7286J

Modular OTDR



See brochure for details: Bulletin AQ7280-01EN

Optical Measuring Instruments

Features

The AQ7280 succeeds the high-end AQ7275 OTDR, which has been used for the installation and maintenance of a wide range of network systems, including core, metro, and access networks.

The AQ7280 has a best-in-class 8.4-inch capacitive touchscreen that supports the same intuitive multi-touch functionality found in smartphones and other handheld devices, allowing users to reposition and resize objects on the screen. The AQ7280 also has the same operation hard keys found on the preceding model. Users can opt to use either the touchscreen or the hard keys.

The AQ7280 series offers remarkable flexibility and convenience with modular measuring units that can be replaced in the field. As new measuring units are developed to keep up with advances in optical technology, the AQ7280 can be modified simply by replacing the measuring unit.

Advanced trace analysis

The OTDR main unit enables advanced analysis of measurement data

Menu name	Type	Evaluation target
Waveform analysis	Multi-trace analysis	Multi-fiber cables
	2-way trace analysis	Connection points with different loss values measured from both directions
Differential trace analysis	Aged deterioration of fibers	

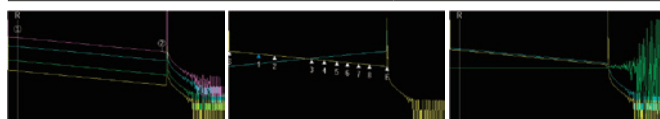

Multi-trace analysis 2-way trace analysis Differential trace analysis

AQ7933 Emulation software

Software to display and analyze the trace data measured on an OTDR. It can also create and output reports of analysis results on a PC. Equipped with the remote controller and file transfer applications, this is a more powerful tool to assist your work.

Collective event analysis

Up to 1000 traces can be loaded. (SOR) It has the function to set events or markers on all loaded traces collectively.

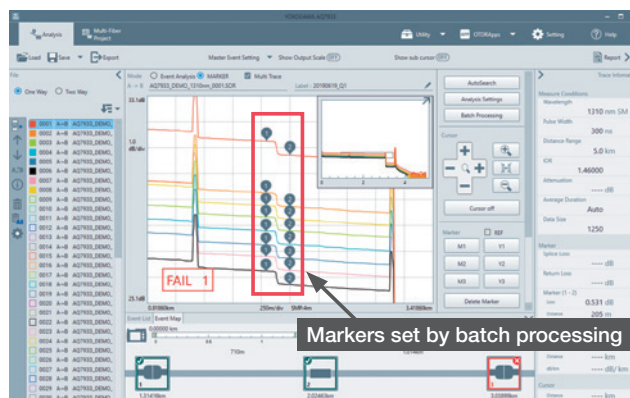

Specifications by Model

● Compatible

OTDR unit	Number of wavelength	Dynamic range (dB)								Test application			Fiber network					
		SM						MM		Installation	Maintenance		Research Manufacturing	Core	Metro	Access	PON	MM fiber
		1310 (nm)	1383 (nm)	1490 (nm)	1550 (nm)	1625 (nm)	1650 (nm)	850 (nm)	1300 (nm)		Dark	Live						
AQ7282A	2	38			36					●	●					●	●	
AQ7283A	2	42			40					●	●					●	●	●
AQ7284A	2	46			45					●	●			●	●	●		
AQ7285A	2	50			50					●	●			●	●	●		
AQ7283E	3	42			40	40 ^{*1}				●	●	●			●	●	●	●
AQ7283F	3	42			40		40 ^{*1}			●	●	●			●	●	●	●
AQ7283H	3	42			40	39				●	●	○ ^{*2}			●	●	●	●
AQ7284H	3	46			45	44				●	●	○ ^{*2}		●	●	●		
AQ7282G	3	38		36	36					●	●					●	●	●
AQ7283K	4	42		38	40	40				●	●	○ ^{*2}			●	●	●	●
AQ7286A	2	42			40								●					
AQ7286H	3	42			40	39							●					
AQ7286J	4	42	39		40	39							●					
AQ7282M	2							25	27	●	●							●

*1: Port2, Built-in filter *2: Compatible when using an external filter

Optical Switch Box for OTDR AQ3550

A 12-channel optical switch box that effectively improves workability with YOKOGAWA OTDRs. Controlled from an OTDR, the OSW allows continuous measurement of all or a subset of the 12 channels. The compact size makes this an ideal solution to conveniently measure multiple ribbon fibers in the field or conserve production test rack space.



Specifications

Display ^{*1}	8.4-inch color TFT LCD (Resolution: 800 × 600, Multi-touch capacitive touchscreen)
Electrical interface	Unit interface × 1, Module interface × 1, USB 2.0 × 3 [Type-A × 2, Type-B (Mini-B) × 1] ^{*2} , Ethernet (10/100BASE-T, Option) × 1, SD card slot × 1
Remote control	USB Type-B (Mini-B), Ethernet (TCP/IP)
Data storage	Internal storage: ≥1000 waveforms
Storage	External storage: USB memory, SD memory card
File format	Write: SOR, CSV, SET, BMP, JPG, CFG, PDF, SMP Read: SOR, SET, SMP
Power requirements	100 to 240 VAC, 50/60 Hz (AC adapter)
Battery	
Type	Lithium-ion
Operating time ^{*3}	15 hours (Telcordia GR-196-CORE Issue2 2010), 10 hours ^{*4} (Continuous measurement)
Recharge time ^{*3}	6 hours
Environmental conditions	
Operating temperature	-10 to 50°C (0 to 40°C when AC adapter is being used, 0 to 35°C when the battery is being charged)
Storage temperature	-20 to 60°C
Humidity	0 to 90% RH (20 to 90% with 739874 AC adapter, non-condensing)
Altitude	4000 m
OTDR functions	
Minimum readout resolution	Horizontal axis: 1 cm, Vertical axis: 0.001 dB
Group refractive index	1.30000 to 1.79999 (in 0.00001 steps)
Distance unit	m, km, mile, kf
Measurement	Distance, Loss, Return loss, Section Return loss, dB/km
Analysis	Multi Trace Analysis, Two-Way Trace Analysis, Difference Trace Analysis, Section Analysis, Macro Bending Analysis
Other functions	Multi Fiber Project, Fault Locator, Work Completion Notice, File Report, Auto Event Search, Pass/Fail Judgment, Fiber Surface Test (Option), Schedule Measurement (Option), Smart Mapper (Option)
Dimensions	Approx. 287 mm (W) × 210 mm (H) × 80 mm (D) (excluding projections)
Weight	Approx. 2.2 kg (including internal battery and protectors, excluding OTDR unit and options)

^{*1} The LCD may contain some pixels that are always ON or OFF (0.002% or fewer of all displayed pixels including RGB), but this is not indicative of a general malfunction. ^{*2} USB Type-A is for external memory, external printer, fiber inspection probe and optical switch box. USB Type-B (Mini-B) is for remote control and internal storage access with a PC. ^{*3} Typical ^{*4} Power save mode, without an option module ^{*5} AQ7280 OTDR mainframe together with an OTDR unit and an OPM/VLS module. ^{*6} 1310 nm of AQ7284A, AQ7285A, AQ7284H, AQ7283K and AQ7286J OTDR units ^{*7} 850 nm of AQ7282M OTDR unit and the Visible Light Sources

Model and Suffix Code

OTDR Mainframe

Model	Suffix Code	Description
AQ7280		AQ7280 OTDR Mainframe
Language	-HJ	Japanese/English
	-HE	English (Multi-language)
	-HM	Chinese
	-HC	Chinese/English
	-HK	Korean/English
	-HR	Russian/English
Options	/MNT	Monitoring function
	/SMP	Smart Mapper function
	/FST	Fiber Surface Test function
	/LAN	Ethernet
	/SB	Shoulder Belt

Standard accessories: Battery pack, hand belt, user's manual (CD-ROM), operation guide

AC adapter (Not included in AQ7280. Please order separately.)

Model	Suffix Code	Description
739874		AC Adapter ^{*1}
Power cord	-D	UL/CSA standard, 125 V
	-F	VDE standard, 250 V
	-H	Chinese standard, 250 V
	-N	Brazilian standard, 250 V
	-P	Korean standard, 250 V
	-Q	BS/Singaporean standard, 250 V
	-R	Australian standard, 250 V
	-T	Taiwanese standard, 125 V
	-A	Argentine standard, 250 V

^{*1} For outside the countries that require CE marking.

OTDR units

Model	Suffix Code	Description
AQ7282A		2WL 1310/1550 nm 38/36 dB
AQ7283A		2WL 1310/1550 nm 42/40 dB
AQ7284A		2WL 1310/1550 nm 46/45 dB
AQ7285A		2WL 1310/1550 nm 50/50 dB
AQ7283E		3WL 1310/1550,1625 nm with filter 42/40, 40 dB
AQ7283F		3WL 1310/1550,1650 nm with filter 42/40, 40 dB
AQ7282G		3WL 1310/1490/1550 nm 38/36/36 dB
AQ7283H		3WL 1310/1550/1625 nm 42/40/39 dB
AQ7284H		3WL 1310/1550/1625 nm 46/45/44 dB
AQ7283K		4WL 1310/1490/1550/1625 nm 42/38/40/40 dB
AQ7286A		2WL 1310/1550nm 42/40dB
AQ7286H		3WL 1310/1550/1625nm 42/40/39 dB
AQ7286J		4WL 1310/1383/1550/1625nm 42/39/40/40 dB
AQ7282M		2WL 850/1300 nm (MM) 25/27 dB
Optical connector	-USC	Universal Adapter (SC)
	-UFC	Universal Adapter (FC)
	-ULC	Universal Adapter (LC)
	-ASC	Universal Adapter (SC Angled-PC) ^{*1}
	-NUA	No universal adapter
Options	/PC	Power Checker ¹ , ² , ³
	/SLS	Stabilized Light Source ³
	/10N	10 nm Wavelength Tolerance ⁴

^{*1} Not applicable to AQ7282M

^{*2} Not applicable to the port 2 of AQ7283E and AQ7283F

^{*3} Not applicable to AQ7286A, AQ7286H and AQ7286J

^{*4} Applicable to AQ7286A, AQ7286H and AQ7286J only

OPM/VLS modules

Model	Suffix Code	Description
AQ2780		OPM Module
AQ2781		High Power OPM Module
AQ2780V		OPM & VLS Module
AQ2781V		High Power OPM & VLS Module
Optical connector	-SCC	Universal Adapter (SC)
	-FCC	Universal Adapter (FC)
	-LMC	Ferrule Adapter (1.25 dia.)

Model	Suffix Code	Description
AQ4780		VLS Module

Accessories (Sold separately)

Model	Suffix Code	Description
SU2005A-SCC	Universal Adapter (SC)	for OTDR unit (Shared by -USC & -ASC)
SU2005A-FCC	Universal Adapter (FC)	for OTDR unit
SU2005A-LCC	Universal Adapter (LC)	for OTDR unit
735480-SCC	Universal Adapter (SC)	for OPM module
735480-FCC	Universal Adapter (FC)	for OPM module
735481-LMC	Ferrule Adapter (1.25 dia.)	for OPM module
735481-SFC	Ferrule Adapter (2.5 dia.)	for OPM module
739860		Soft Carrying Case
739883		Battery Pack
B8070CY		Shoulder Belt
AQ3550-112-SA-SCC	AQ3550 Optical Switch Box (SC)	for SM ⁵

^{*1}All universal adapters of OPM module are Angled-PC compatible.

^{*5} AQ3550 is not available with AQ7282M

Additional option license

Model	Suffix Code	Description
735050		Additional option license for AQ7280
-	-MNT	Monitoring function
	-SMP	Smart Mapper function
	-FST	Fiber Surface Test function

Application software

Model	Suffix Code	Description
AQ7933		AQ7933 Emulation Software
-	-SP01	Download version (1-license)
	-SC01	Package version (1-license with CD)
735071		AQ7940 Optical Fiber Monitoring Software
-	-HE	English/Japanese

Complete Testing Capabilities in a Compact and Light Package

—Smart, Compact, Full-Featured OTDR—



See brochure for details: Bulletin AQ1210-01EN

Features

The AQ1210 is a latest model of MFT-OTDR. The AQ1210 is a multifunctional handheld OTDR that combines all the necessary field test functions in one unit. It offers various functions, including an OTDR function that features short 50 cm event dead zone, a fault locator function that is effective in locating a fault, a loss test function that combines light sources and an optical power meter (option) in one unit, and a visible light source (option). You can also connect a fiber endface inspection probe. The AQ1210 retains the interface of the very popular AQ1200 or AQ7280 series. So you can use the variety of functions and the user-friendly interface.

Applications

PON optimized

Excellent hardware performance and advanced analysis algorithm enable the AQ1210 to accurately characterize Passive Optical Networks (PON) through high-port-count splitters (up to 1 × 128)*. The AQ1210 assists beginner/expert users in simply configuring OTDR measurement settings based on PON topology information for optimal results. Short event dead zone and high sampling resolution enable users to detect as close as 0.5 meters (<20 inches)*.

*Typical, with AQ1215A/E/F and AQ1216F

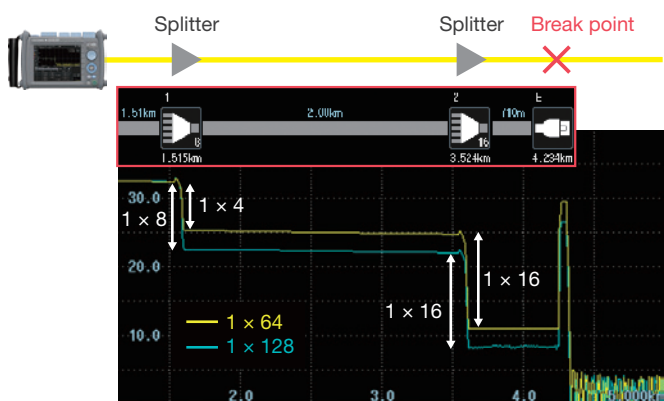

Measurements over a 128 and 64-port splitter

Multi-tasking

While the OTDR measurement is in progress, other functions such as optical power meter, visible light source, and optical fiber inspection probe can also be used at the same time. This unique multi-tasking feature reduces “idle time” during the measurements and contributes to improved work efficiency. For example, checking the surface of or measure the optical power of one fiber while measuring another fiber with OTDR function. However, the OTDR, stabilized light source and power checker functions cannot be used simultaneously because these share the same port.



Example of multi-tasking with OTDR, optical power meter, and visible light source

Connectivity

By connecting the instrument to an external device (PC, mobile device) via USB cable or wired/wireless LAN adapter, easily perform file transfer and remote control using a web browser or application software.

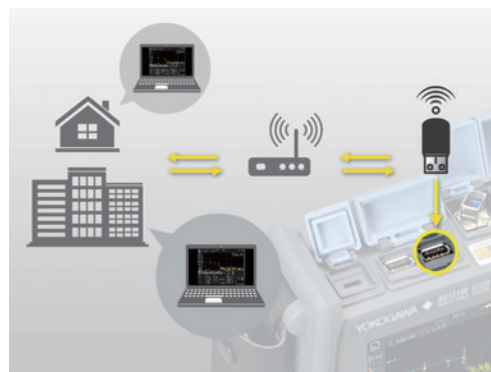

Data transporter

Application software for mobile device (iOS and Android) that enables data transfer between an OTDR and a mobile device. By using the data transporter, the AQ1210's data files are able to be saved to cloud storage or be attached to an email by a mobile device connected to the AQ1210 with wireless LAN. Simple analysis of loaded trace data is also possible.

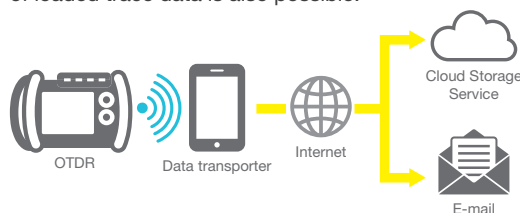

Specifications

General specifications

Display ¹	5.7-inch color TFT LCD (resolution: 640 × 480, multi-touch capacitive touchscreen)
Interfaces	USB 2.0 Type-A × 2: USB mass storage device, fiber inspection probe, wired LAN adapter, wireless LAN adapter USB 2.0 Type-C × 1: DC power supply, storage, remote control
Data storage	Storage Internal: ≥1000 traces, external: USB storage File format Write: SOR, CSV, SET, SMP, BMP, JPG, PDF Read: SOR, SET, SMP
Power requirements ²	USB power supply (Type-C), DC 5 V ±5%, max. 3 A
Battery ³	Type: Lithium ion polymer Operation time: 10 hours or more (Telcordia GR-196-CORE Issue 2, September 2010), Recharge time: 5 hours (power-off state)
Environmental conditions	Operating temperature: -10 to 50°C (10 to 35°C when charging the battery), operating humidity: ≤95%RH (non-condensing), storage temperature: -20 to 60°C, storage humidity: ≤95%RH (non-condensing), altitude: 4000 m, dust and drip protection: IP51 equivalent ⁴
Dimensions	Approx. 210 mm (W) × 148 mm (H) × 69 mm (D) (excluding projections)
Weight	Approx. 1 kg (including battery)
Minimum readout resolution	Horizontal axis: 1 cm, vertical axis: 0.001 dB
Group refractive index	1.30000 to 1.79999 (0.00001 intervals)
Distance unit	m, km, mile, kft
Number of sampling points	max. 256000
Distance measurement accuracy	± (0.75 m + measured distance × 2 × 10 ⁻⁵ + sampling resolution)
Optical return loss measurement accuracy	±2 dB

- *1: The LCD may contain some pixels that are always on or off (0.002% or fewer of all displayed pixels including RGB), but this is not indicative of a general malfunction.
 *2: Require approx. 3 amperes for recharging during operation, approx. 2 amperes for recharging in power-off state.
 *3: Typical.
 *4: All the lids are being closed.

Specifications by Model

	AQ1210A	AQ1215A	AQ1210E	AQ1215E	AQ1215F	AQ1216F	AQ1210D
Wavelength (nm) ¹	1310 ±20/1550 ±20		1310 ±20/1550 ±20, 1625 ±10	1310 ±20/1550 ±20, 1625 ±20	1310 ±20/1550 ±20, 1650 ±5 ²	1310 ±20/1550 ±20, 1650 ±20	1310 ±20/1550 ±20, 850 ±15/1300 ±30
Number of optical ports	1		2 (Port 2: 1625 nm, including a filter)		2 (Port 2: 1650 nm, including a filter)		2 (Port 2: 850/1300 nm)
Applicable fiber	SM (ITU-T G.652)						
Distance range (km)	0.1 to 256	0.1 to 512	0.1 to 256	0.1 to 512		0.1 to 256, 0.1 to 100	
Pulse width (ns)	5 to 20000	3 to 20000	5 to 20000	3 to 20000		5 to 20000, 3 to 1000/3 to 5000	
Event dead zone (m) ^{1,3}	0.75	0.5	0.75	0.5		0.75, 0.5	
Attenuation dead zone (m) ^{1,4}	4	2.5	4	2.5		4, 2.5	
PON dead zone (m) ^{1,5}	35	30	35	30		35, —	
Dynamic range (dB) ^{1,6}	37/35	42/40	37/35, 35	42/40, 39	42/40, 37	42/40, 40	37/35, 25/27
Loss measurement accuracy ⁷	±0.05 dB/dB	±0.03 dB/dB	±0.05 dB/dB	±0.03 dB/dB		±0.05 dB/dB	
Sampling resolution	min. 5 cm	min. 2 cm	min. 5 cm	min. 2 cm		min. 5, 2 cm	

- *1: Typical.
 *2: At 20 dB below the spectral peak of pulsed optical output, at 23°C, after 30 minutes warm up.
 *3: Minimum pulse width, return loss: ≥55 dB (≥40 dB for 850/1300 nm), group refractive index: 1.5, at 1.5 dB below the unsaturated peak level.
 *4: Pulse width: 10 ns, group refractive index: 1.5, at a point where the backscatter level is within ±0.5 dB of the normal level. For SMF, at 1310 nm, return loss: ≥55 dB. For MMF, at 850 nm, return loss: ≥40 dB.

Model and Suffix Code

Model	Suffix Code	Description
AQ1210A		2WL 1310/1550 nm 37/35 dB
AQ1215A		2WL 1310/1550 nm 42/40 dB
AQ1210E		3WL 1310/1550, 1625 nm 37/35, 35 dB ¹
AQ1215E		3WL 1310/1550, 1625 nm 42/40, 39 dB ¹
AQ1215F		3WL 1310/1550, 1650 nm 42/40, 37 dB ¹
AQ1216F		3WL 1310/1550, 1650 nm 42/40, 40 dB ¹
AQ1210D		4WL 1310/1550, 850/1300 nm 37/35, 25/27 dB
Language	-HE	English (Multi-language)
	-HM	Chinese
	-HC	Chinese/English
	-HK	Korean/English
	-HR	Russian/English
Optical connector	-USC	Universal adapter (SC)
	-UFC	Universal adapter (FC)
	-ULC	Universal adapter (LC)
	-ASC	Universal adapter (SC Angled-PC) ²
Options	Optical Power Meter (OPM) ³	/SPM Standard optical power meter /HPM High power optical power meter /PPM PON optical power meter
	Power Checker ³	/PC Integrated optical power meter
	Visible Light Source ³	/VLS Optical connector: 2.5 mm diameter ferrule type
Fiber Surface Test function	/FST	Pass/fail judgment
Shoulder Belt	/SB	

- Standard accessories: Connecting cable for USB power adapter, hand belt, start-up guide
 *1: The OTDR port for 1625 or 1650 nm is equipped with a built-in filter.
 *2: When -ASC is selected, OTDR port is SC Angled-PC connector and OPM port is SC connector. As for optional accessories, only -ASC of 735482 can be selected for OTDR port, and any type of 735480 and 735481 can be selected for OPM port.
 For the AQ1210D, when -ASC is selected OTDR port 1 (SM) is -ASC, and OTDR port 2 (MM) is -USC. There is no option to select -ASC for OTDR port 2 (MM).
 *3: The options cannot be added after shipping.

Good Things Come in Small Packages



Features

This AQ1000 is specifically designed to increase the productivity of field personnel working on the installation and deployment of optical access networks such as Fiber To The Home (FTTH). Although it is positioned as an entry-level model, it still retains Yokogawa's established standards of quality/reliability and features characteristics which are usually present in higher-level models, such as a high-quality capacitive multi-touch touchscreen and wireless connectivity.

- Wavelengths: 1310/1550 nm
- Dynamic ranges: 32/30 dB
- Multi-touch touchscreen
- OTDR view modes: Trace view/Map view
- Long battery operation time
- Quick boot-up
- One-button measurement
- Measurements: Distance, Loss, Event search, Pass/Fail
- Built-in Power checker and Light Source, and VLS
- PDF reporting
- Wireless LAN
- USB power feeding

Specifications

OTDR

Wavelength (nm) ¹	1310 ±20/1550 ±20
Applicable fiber	SM (ITU-T G.652)
Distance range (km)	0.2, 0.5, 1, 2, 5, 10, 20, 30, 50, 100, 200, 256
Pulse width (ns)	3, 10, 20, 30, 50, 100, 200, 300, 500, 1000, 2000, 5000, 10000, 20000
Sampling resolution	min. 5 cm
Number of sample points	max. 256000
Distance measurement accuracy (m)	±(1 m + Measurement distance × 2 × 10 ⁻⁵ ±1 sampling resolution)
Event dead zone (m) ²	≤ 0.8
Attenuation dead zone (m) ^{1,3}	4/5
Dynamic range (dB) ^{1,4}	32/30
Loss measurement accuracy	±0.03 dB/dB
Reflection accuracy	±2 dB
Laser class ⁵	Class 1M or 1

General specifications

Display ⁶	5.0 inch color TFT LCD WVGA (Capacitive touchscreen) Resolution: 800 × 480 pixel
External interfaces	USB2.0 × 2 (Type A × 1: Host, Type micro B × 1: USB mass storage devices, DC power supply) Wireless LAN (WLAN option): IEEE802.11b/g/n
Dimensions	185 mm (W) × 116 mm (H) × 56 mm (D) (excluding projections)
Weight	Approx. 660 g
Environmental conditions	
Temperature	Operating: -10°C to 50°C, (10 to 35°C during charging, excluding a USB power adapter) (0 to 50°C when WLAN using) Storage: -20°C to 60°C
Humidity	5 to 90%RH (No condensation)
Altitude	4000 m or less
Power requirements	DC 5 V±10%, max. 1.5 A
Battery	Type Lithium ion polymer
Operating time	10 hours or more (Telcordia GR-196-CORE Issue 2, September 2010)
Recharge time	5 hours (typical)

Power checker (Integrated optical power meter)

Wavelength setting (nm)	1310/1490/1550/1625/1650
Measurement range (dBm)	-50 to -5
Measurement accuracy (dB) ⁷	±0.5

Stabilized light source

Wavelength (nm)	1310 ±25/1550 ±25
Optical output level	-3 dBm ±1 dB
Output power stability (dB) ⁸	±0.05
Modulation mode	CW, 270 Hz, 1 kHz, 2 kHz
Laser class ⁵	Class 1M or 1

Visible light source (VLS option)

Wavelength (nm)	650 ±20
Optical output level	-3 dBm or more (Peak)
Modulation mode	CW, 2 Hz
Laser class ⁹	Class 3R

*1: Typical. *2: Pulse width = 3 ns, Return loss ≥ 55 dB, at a 1.5 dB or less point from an unsaturated peak level. *3: Pulse width = 10 ns, Return loss ≥ 55 dB, at a point where the backscatter level is within ±0.5 dB of the normal level. *4: Pulse width = 10000 ns, Measurement time = 3 minutes, Sampling resolution = 8 m, SNR = 1. *5: Class 1M: IEC 60825-1: 2007, GB 7247.1-2012, Class 1: EN 60825-1: 2014. *6: The LCD may contain some pixels that are always ON or OFF (0.002% or fewer of all displayed pixels including RGB), but this is not indicative of a general malfunction. *7: CW, 1310 nm (with a spectral width of 10 nm or less), Optical input power 100 μW (-10 dBm), SM fiber (ITU-T G.652) with FC/PC connector, Wavelength setting: Measured wavelength ±0.5 nm, Excluding a secular change of equipment. (add 1% one year after calibration.) *8: For 5 minutes at a constant ambient temperature within 23°C ±2°C. *9: EN 60825-1: 2014, IEC 60825-1: 2007, GB 7247.1-2012

Note.

All the specifications are valid at 23°C ±2°C and after a warming up for 5 minutes or more, unless otherwise stated.

Model and Suffix Code

Model	Suffix Code	Description
AQ1000		AQ1000 OTDR
Optical connector	-USC	Universal Adapter (SC)
	-UFC	Universal Adapter (FC)
	-ASC	Universal Adapter (SC Angled-PC)
Visible light source	/VLS	Visible Light Source
Wireless LAN*	/WLAN	Wireless LAN

*The use of wireless LAN is subject to the regulation of each country. For more detail, please consult with our sales representatives.



See brochure for details: LF OPM&LD-02EN

Features

Due to the increase in broadband services such as FTTH (Fiber To The Home), the communication carriers are reinforcing the infrastructure of optical fiber networks. In the introductory period of such networks, there is a strong need for handy OPM/LS for installation and maintenance together with OTDRs. the AQ2170, AQ2170H, AQ2180 and AQ2180H Optical Power Meters, and the AQ4280A, AQ4280B and AQ4280C Optical Light Sources to address installation and maintenance needs.

Specifications

Optical Power Meter AQ2170/AQ2180

	AQ2170	AQ2170H	AQ2180	AQ2180H
Wavelength setting	850/1300/1310/1490/1550/1625/1650 nm	1310/1490/1550/1625/1650 nm	850/1300/1310/1490/1550/1625/1650 nm	1310/1490/1550/1625/1650 nm
Detector	InGaAs			
Applicable optical fiber	SM (ITU-T G.652), GI (50/125 μm), GI (62.5/125 μm)	SM (ITU-T G.652)	SM (ITU-T G.652), GI (50/125 μm), GI (62.5/125 μm)	SM (ITU-T G.652)
Power range	-70 to +10 dBm	-50 to +26 dBm	-70 to +10 dBm	-50 to +26 dBm
Noise level	-60 dBm	-40 dBm	-60 dBm	-40 dBm
Uncertainty ¹	±5%			
Modulation mode	CW, CHOP (270 Hz, 1 kHz, 2 kHz)			
Memory function	—		999 records	
Interface	—		USB-B (mini)	
Power supply	AAA dry or rechargeable battery		AA dry or rechargeable battery	
Battery life time ²	Approx. 40 hours			
Dimensions and weight ³	63 (W) mm × 116 (H) mm × 35 (D) mm, approx. 160 g		76 (W) mm × 153 (H) mm × 43 (D) mm, approx. 280 g	
Accessories	Connector adapters, four AAA dry batteries, carrying case, protector, strap operation guide, user's manual (CD)		Connector adapters, two AA dry batteries, carrying case, protector, strap operation guide, user's manual (CD)	



Optical Light Source AQ4280

	AQ4280A	AQ4280B	AQ4280C
Light emitting element	LD		
Applicable optical fiber	SM (ITU-T G.652)		
Center wavelength	1310/1550 ±20 nm	1310/1550 ±20 nm, 1490 ±10 nm	1310/1550 ±20 nm, 1490/1625 ±10 nm
Spectral width ^{4, 5}	< 5 nm (1310 nm), < 10 nm (1550 nm)	< 5 nm (1310 nm, 1490 nm), < 10 nm (1550 nm)	< 5 nm (1310 nm, 1490 nm, 1625 nm), < 10 nm (1550 nm)
Output power level ⁶	-5 dBm ±1 dB		
Power stability (15 min.) ^{4, 6}	< ±0.05 dB	< ±0.05 dB (1310/1550 nm), < ±0.1 dB (1490 nm)	< ±0.05 dB (1310/1550 nm), < ±0.1 dB (1490/1625 nm)
Modulation	CW, CHOP (270 Hz, 1 kHz, 2 kHz)		
Power supply	AA dry or rechargeable battery		
Battery life time ⁷	Approx. 25 hours		
Dimensions/Weight ³	76 (W) mm × 153 (H) mm × 43 (D) mm, approx. 300 g		
Accessory	Connector adapters, two AA dry batteries, carrying case, protector, strap, operation guide, user's manual (CD)		



¹: Power level: 100 μW (-10 dBm), CW, wavelength: 1310 nm, spectral width: 5 nm or less (1310 nm), ambient temperature: 23 ±2°C, optical fiber: SM (ITU-T G.652), optical connector: FC/PC, excluding polarization dependence, including attachment and detachment of connector adapter, within 1 year.
²: Continuous measurement, using alkaline dry cells, at 23°C ±2°C
³: Excluding the protector
⁴: Constant temperature within 23 ±2°C, CW light
⁵: RMS (2σ, -20 dB)
⁶: With an optical fiber cord (FC/PC, 2 m)
⁷: Using alkaline dry cells, continuous measurement

Note. All the specifications are valid at 23 ±2°C and with the FC adapter, unless otherwise stated.

Model and Suffix Code

Model	Suffix Code	Description
AQ2170	—	Optical Power Meter
AQ2170H	—	Optical Power Meter (High power)
AQ2180	—	Optical Power Meter
AQ2180H	—	Optical Power Meter (High power)
AQ4280A	—	Optical Light Source (1310/1550 nm)
AQ4280B	—	Optical Light Source (1310/1490/1550 nm)
AQ4280C	—	Optical Light Source (1310/1550,1490/1625 nm)
option	/CAL	Calibration* (The calibration certificate is not included.)

*For ordering the calibration certificate (model: 735993), the /CAL option is required, and the calibration certificate can only be issued at the time of product delivery. It cannot be issued after the product delivery.

Light Source + Optical Power Meter in One

Excellent Functionality and Operability



See brochure for details: Bulletin AQ1100-00E

Features

The AQ1100 is an optical loss test set combining an optical power meter and light sources in one unit. An optical power meter is a measuring instrument usually used for optical loss tests. The AQ1100 supports up to MM850/1300 nm and SM1310/1550/1625 nm. Also, you can select a +27 dBm high power optical meter. For the light source, three models are available depending on the wavelength and fiber type used. For the optical power meter, you can select from three models depending on the measurement power and the purpose of the optical power meter.

Specifications

Light source

	AQ1100A	AQ1100B	AQ1100D
Wavelength (nm) ¹	1310/1550 ±25	1310/1550/1625 ±25	1310/1550 ±25 (SM) 850/1300 ±30 (GI)
Light emitting device	LD	LD	LD (SM), LED (GI)
SM (LD) Spectral width (nm) ^{1,2}	<5 / <10	<5 / <10 / <10	<5 / <10
GI (LED) Spectral width (nm) ^{1,3} (FWHM)	—	—	40 (typ.)/140 (typ.)
Optical output level (dBm)	-3 ±1	-3 ±1	SM: -3 ±1, GI: -20 ±1
Level stability (dB) ⁴	±0.05	±0.05	SM: ±0.05, GI: ±0.1
Modulation mode	CW, CHOP (270 Hz, 1 kHz, 2 kHz) ⁵		
Applicable fiber	SM (ITU-T G.652)		SM (ITU-T G.652), GI (50/125 μm)
Optical Connector	SC, FC, 1.25 mm dia. ferrule, SC/Angled-PC		SC, FC, 1.25 mm dia. ferrule

Built-in Optical Powermeter

	Standard (/SPM)	High Power (/HPM)	PON (/PPM)
Wavelength setting	Simple mode: 850/1300/1310/1490/1550/1625/1650 nm Detail mode: 800 nm to 1700 nm, 1 nm step CWDM mode: 1270 nm to 1610 nm 20 nm step		1310/1490/1550 nm (1490 nm and 1550 nm can be measured separately)
Applicable fiber	SM (ITU-T G.652), GI (50/125 μm)		SM (ITU-T G.652)
Power range	+10 to -70 dBm (CW) +7 to -70 dBm (CHOP)	+27 to -50 dBm (CW) +24 to -50 dBm (CHOP) ⁶	+27 to -50 dBm: 1550 nm +10 to -70 dBm: 1310/1490 nm
Noise level	0.5 nW (-63 dBm, 1310 nm)	50 nW (-43 dBm, 1310 nm)	0.5 nW (-63 dBm, 1310 nm), 50 nW (-43 dBm, 1550 nm)
Uncertainty under standard conditions ⁷	±5%	±5%	±0.5 dB (10%)
Readout resolution	0.01		
Level unit	Absolute: dBm, mW, μW, nW Relative: dB		
Modulation mode	CW, CHOP (270/1 k/2 kHz)		CW
Average function	1, 10, 50 and 100 times		
logging function	Measurement intervals: 500 ms, 1 s, 2 s, 5 s, 10 s, Measurement count: 10 to 36000		

General specifications

Display	5.7 inch color LCD (640 × 480)
Loss test mode (only with /SPM or /HPM)	Auto loss test, Loopback test, Multi-core loss test
Internal memory	128 MByte
External interface	USB1.1 TypeA and TypeB (mini) 1 ea.
Power supply	
AC adaptor	100 to 120 VAC, 200 to 240 VAC, 50/60 Hz
Battery	Li-ion, duration 6 hour ⁸ , charging time 5 hours
Dimensions and mass	217.5 mm (W) × 157 mm (H) × 74 mm (D) (excl. projections) Approx. 1 kg (incl. internal battery)
Environmental condition	
Operating environment	Temperature 0 to 45°C (0 to 35°C when charging the battery) Humidity 85% RH or less (no condensation)
Storage environment	Temperature -20 to 60°C, Humidity 85% RH or less (no condensation)

Factory Installed Options

Visible light source (/VLS)	
Optical connector	2.5 mm dia. ferrule type
Wavelength and optical output level	650 nm ±20 nm, peak value -3 dBm or more
Modulation mode	CHOP, 2 Hz
Laser class	Class 3R
LAN interface (/LAN)	
10BASE-T/100BASE-TX, RJ-45 connector	Ping test, PC remote control

The specifications are at 23°C ±2°C unless otherwise noted. *1: 23°C ±2°C, CW *2: RMS (2σ, -20 dB)
*3: Envelope (-3 dB) *4: for 15 minutes at a constant temperature within 23°C ±2°C *5: CW and 270 Hz only at 850 nm and 1300 nm *6: Except for 850 nm and 1650 nm. *7: 23°C ±2°C, standard conditions (CW, 1310 nm, 100 μW, SMP), at 1550 nm for /PPM. *8: LD ON. (in screen save mode) *9: The visible light sources

Model and Suffix Code

Model	Suffix Code	Description
AQ1100A		LS: 1310/1550 nm
AQ1100B		LS: 1310/1550/1625 nm
AQ1100D		LS: MM850/1300, SM1310/1550 nm
Language	-HE	English
	-HC	Chinese/English
	-HK	Korean/English
	-HR	Russian/English
Power cord	-D	UL/ CSA standard, 125 V
	-F	VDE standard, 250 V
	-R	Australian standard, 250 V
	-Q	BS/Singaporean standard, 250 V
	-H	Chinese standard, 250 V
	-P	Korean standard, 250 V
Optical power meter	-SPM	Optical power meter
	-HPM	High power optical power meter
	-PPM (AQ1100A only)	PON Optical power meter
Optical connector	-USC	SC type (LS port, and OPM port)
	-UFC	FC type (LS port, and OPM port)
	-ULC	LC type (LS port, and OPM port for -PPM), 1.25 mm dia. adapter (OPM port for -SPM and -HPM)
	-ASC (except AQ1100D)	SC/Angled-PC type (LS port, and OPM port for -PPM), SC type (OPM port for -SPM and -HPM)
Factory installed options	/VLS	Visible light source, optical connector: 2.5 mm dia. ferrule
	/LAN	Ethernet (10/100BASE-TX)
	/SB	Shoulder belt
AC adaptor	/AC1	Alternative AC adapter*

*For the countries that require CE marking.

■Standard Accessories: Power cord, AC adaptor, battery pack, hand belt, user's manual (CD-ROM), operation guide

Optional Accessories

Model	Suffix Code	Description
SU2006A		Soft carrying case
735480	-SCC	Connector adapter (SC)
(For opticalpower meters)	-FCC	Connector adapter (FC)
735481	-LMC	Ferrule adapter (1.25 mm dia.)
SU2005A	-SCC	Universal adapter (SC)
(For LS and PON optical power meter)	-FCC	Universal adapter (FC)
	-LCC	Universal adapter (LC)
739874 (AC adaptor)	-D	UL/CSA standard, 125 V
	-F	VDE standard, 250 V
	-R	Australian standard, 250 V
	-Q	BS/Singaporean standard, 250 V
	-H	Chinese standard, 250 V
	-P	Korean standard, 250 V
	-T	Taiwanese standard, 125 V
	-N	Brazilian standard, 250 V
739882		Battery pack (Spare)
B8070CY		Shoulder belt

Handheld 1 G/10G Ethernet Tester Support 10 M to 1 G/10 G Ethernet Easy to Operate for Network Path Testing and Maintenance



See brochure for details: Bulletin AQ1300-02EN

Features

The AQ1300 series is a compact and lightweight Ethernet tester that is designed to improve both work efficiency and quality at the same time, with function optimized for the network path testing and maintenance of Ethernet networks up to 1 G or 10 G depending on model chosen. Easy operation prevents operational errors and stabilizes work quality for routine tasks such as network path testing. Powerful analysis functions help isolate failures during maintenance work.

The AQ1300 series has two models, AQ1300 and AQ1301 to choose from depending on the measurement interface and bit rate. You can choose the model suitable for your test needs.

Specifications

General specifications

Display	5.7-inch color LCD (640 × 480)
External interface	USB1.1 Type A and Type B (mini), LAN (RJ-45) × 1
Power supply	AC adapter 100 to 240 V, 50 to 60 Hz Battery (Li-ion) operation time 1 hour
External dimensions	217.5 (W) × 157 (H) × 74 (D) mm
Weight	Approx. 1.3 kg (including internal battery)

Other specifications

Interface	RJ-45	10BASE-T, 100BASE-TX, 1000BASE-T
	SFP	100BASE-FX, 1000BASE-SX, 1000BASE-LX
	XFP ¹	10GBASE-SR, 10GBASE-LR, 10GBASE-ER
Measurement function	Measurement menu	Auto, Auto (Remote), Manual, OPM (Optical power meter) ²
	Measurement mode	TRAFFIC, QoS, PING, Loop Back, BERT
	RFC2544	Throughput, Latency, Frame loss rate, Back-to-Back, Packet Jitter
Transmission function	Frame length	48 to 9999 bytes
	QoS transmission	Up to 8 channels [up to 4 ch in Auto and Auto (remote) mode]
	Receive function	
Receive function	Receivable frame length	48 to 9999 bytes (Minimum IFG: 5 bytes)
	Latency time measurement resolution	100 ns

Loop back function		DA/SA of MAC address, DA/SA of IP address, Dst/Src port of TCP/UDP
Field swap		
Remote control function		
In-band remote		Remote test synchronization, Remote test start synchronization, Opposite tester automatic search*, Opposite tester automatic addressing* *Applicable only within a segment
Layer-1 measurement function		
Receiving clock measurement		Measurement range: -100 to +100 ppm Measurement resolution: 0.1 ppm
LFS generation ³		Manual: Continuous transmission (Start/Stop), Auto: When a link down or LF is received, RF is transmitted automatically.

¹: Only available for the AQ1300

²: Only available for the AQ1300 (option)

³: When the interface is XFP (10 G)

Model and Suffix Code

Model	Suffix Code	Description
AQ1301		AQ1301 MFT-1GbE
AQ1300		AQ1300 MFT-10GbE
Language	-HE	English
Power cord	-D	UL/CSA standard, 125 V
	-F	VDE standard, 250 V
	-R	Australian standard, 250 V
	-Q	BS/Singaporean standard, 250 V
	-H	Chinese standard, 250 V
	-P	Korean standard, 250 V
	-T	Taiwanese standard, 125 V
Optical power meter ¹	/SPML	Standard Optical power meter
XFP module ^{1,2}	/SR	10GBASE-SR XFP module
	/LR	10GBASE-LR XFP module
	/ER	10GBASE-ER XFP module
SFP module ²	/SX	1000BASE-SX SFP module
	/LX	1000BASE-LX SFP module
RFC2544 ³	/BM	RFC2544 function
Shoulder belt	/SB	Shoulder belt

¹: Cannot be specified for the AQ1301

²: For the SFP and XFP modules, be sure to use the modules listed above. If you use other than an SFP or XFP module from Yokogawa, the functionality and performance of this product are not guaranteed. Furthermore, the warranty will be void.

³: Cannot be specified for the AQ1301 (this option is available for the AQ1301 as standard)

Optional Accessories

Model	Suffix Code	Description	
735454		Optical transceiver module	
	-SR ⁴	10GBASE-SR XFP module	
	-LR ⁴	10GBASE-LR XFP module	
	-ER ⁴	10GBASE-ER XFP module	
	-SX	1000BASE-SX SFP module	
	-LX	1000BASE-LX SFP module	
739882		Battery pack (reserve)	
SU2006A		Soft carrying case	
739874		AC adapter	
	Power cord	-D	UL/CSA standard, 125 V
		-F	VDE standard, 250 V
		-R	Australian standard, 250 V
		-Q	BS/Singaporean standard, 250 V
		-H	Chinese standard, 250 V
		-P	Korean standard, 250 V
-T		Taiwanese standard, 125 V	
B8070CY		Shoulder belt	
735480 ⁴	-SCC	SC connector adapter for optical power meters	
	-FCC	FC connector adapter for optical power meters	
735481	-LMC	Ferrule Adapter (1.25 mm dia.)	
	-SFC	Ferrule Adapter (2.5 mm dia.)	

⁴: Cannot be used with the AQ1301.

Process Calibrator Selection Guide



... P.92



... P.96



... P.98

Item	Product Type/ Model	Pressure Calibrator			Multi Function Calibrator			Multi Function Calibrator						
		CA700			CA500			CA550			CA71/CA51			
Source and measurement Form		Source and measurement Simultaneous (pressure and voltage/current)			Source and measurement Simultaneous			Source and measurement Simultaneous			Source and measurement Simultaneous			
Source Function	DC voltage (DC voltage)	5 V (0.015% of setting)			100 mV/1-5/5/30 V (0.015% of setting)			100 mV/1-5/5/30 V (0.015% of setting)			100 mV/1/10/30 V (0.02% of setting)			
	DC current (DCmA)	20 mA (0.015% of setting)			20/4-20 mA (0.015% of setting)			20/4-20 mA (0.010% of setting)			20/4-20 mA (0.025% of setting)			
	DC current (mA SIMULATE)	20 mA (0.015% of setting)			20 mA (0.015% of setting)			20 mA (0.010% of setting)			20 mA (0.05% of setting)			
	Resistance (Ω)	—			400/4000 Ω (0.020% of setting)			400/4000 Ω (0.015% of setting)			400 Ω (0.025% of setting)			
	Resistance temperature detector (RTD)	—			Pt100/JPt100/Pt200/Pt500/Pt1000/Cu10/Ni120/Pt50/Pt50G/Pt100G/Cu50M/Cu100M ³			Pt100/JPt100/Pt200/Pt500/Pt1000/Cu10/Ni120/Pt50/Pt50G/Pt100G/Cu50M/Cu100M ³			Pt100/JPt100 (0.025% of setting)			
	Thermocouple (TC)	—			K/E/J/T/N/L/U/R/S/B/C/XK/A/D/G/PLATINEL II/PR20-40 ³			K/E/J/T/N/L/U/R/S/B/C/XK/A/D/G/PLATINEL II/PR20-40 ³			K/E/J/T/N/L/U/R/S/B (0.02% of setting)			
	Frequency (Hz) Pulse (PULSE)	Output pulse setting	—			500/5000 Hz/50 kHz, 1100.0/min ³			500/5000 Hz/50 kHz, 1100.0/min ³			500/1000 Hz/10 kHz, 99999 cycles ⁴		
Output voltage		—			+0.1 V to +15 V			+0.1 V to +15 V			+0.1 V to +15 V			
Dry contact		—			●			●			●			
Measurement Function	AC voltage (AC voltage)	—			—			—			1/10/100/300 V (0.5% of reading)			
	DC voltage (DC voltage)	5 V/50 V (0.015% of reading)			100 mV/5/50 V (0.015% of reading)			100 mV/5/50 V (0.015% of reading)			100 mV/1/10/100 V (0.025% of reading)			
	DC current (DCmA)	20 mA/100 mA (0.015% of reading)			50 mA (0.015% of reading)			50 mA (0.010% of reading)			20/100 mA (0.025% of reading) ¹			
	Resistance (Ω)	—			400/4000 Ω (0.020% of reading)			400/4000 Ω (0.015% of reading)			400 Ω (0.05% of reading)			
	Resistance temperature detector (RTD)	—			Pt100/JPt100/Pt200/Pt500/Pt1000/Cu10/Ni120/Pt50/Pt50G/Pt100G/Cu50M/Cu100M ³			Pt100/JPt100/Pt200/Pt500/Pt1000/Cu10/Ni120/Pt50/Pt50G/Pt100G/Cu50M/Cu100M ³			Pt100/JPt100 (0.05% of reading) (CA71 only)			
	Thermocouple (TC)	—			K/E/J/T/N/L/U/R/S/B/C/XK/A/D/G/PLATINEL II/PR20-40 ³			K/E/J/T/N/L/U/R/S/B/C/XK/A/D/G/PLATINEL II/PR20-40 ³			K/E/J/T/N/L/U/R/S/B (0.05% of reading) (CA71 only)			
	Frequency (Hz)	—			500/5000 Hz/50 kHz ³			500/5000 Hz/50 kHz ³			100/1000 Hz/10 kHz			
	Pulse (PULSE)	—			0 to 99999 ³ Maximum integration time: 60 min			0 to 99999 CPM 0 to 99999 CPH			0 to 99999 CPM 0 to 99999 CPH			
	24 V loop power supply	●: 24 V ± 1 V (communication resistance OFF) ●: 24 V ± 6 V (communication resistance ON)			●: 24 V ± 2 V (communication resistance ON/OFF)			—			●: No regulations ⁵ (No communication resistance mode)			
	Pressure	200 kPa/1000 kPa/3500 kPa ² (0.02% of reading)			—			—			—			
General specifications/functions	Display	Dot matrix LCD			Dot Matrix LCD			—			Segment LCD			
	Source pattern	Step sweep	●: 15/30/45/60 seconds			●: 5 to 600 seconds			—			●: 2.5/5 seconds		
		Linear sweep	●: 15/30/45/60 seconds			●: 5 to 600 seconds			—			●: 16/32 seconds		
		Span check	●			●			—			—		
		Program sweep	—			●: 5 to 600 seconds			—			—		
	Data memory	As Found/As Left/error rate pass or fail judgment (250 Data)			●: 100 data			●: 250 files (CSV files)			●: 50 data			
	Communication interface	USB			USB TYPE B			—			RS232C (CA71 only)			
	Power supply	Six alkaline AA batteries			Four alkaline AA batteries			—			Four alkaline AA batteries AC adapter (Sold separately)			
	Battery life (alkaline AA batteries)	35 hours (when 24 V loop power supply is OFF during current measurement) Approx. 10 hours (when 24 V loop power supply is ON)			Approx. 16 hours (Measurement ON, 5 V output/10 kΩ or more)			—			Approx. 40 hours (measurement OFF, output DC 5 V/10 kΩ or more) Approx. 20 hours (source/measurement simultaneously, output DC 5 V/10 kΩ or more) Approx. 12 hours (source/measurement simultaneously, output 20 mA/5 V)			
	Dimensions Approx	264 (W) × 188 (H) × 96 (D) mm			Approx. 130 (W) × 260 (H) × 53 (D) mm			—			190 (W) × 120 (H) × 55 (D) mm			
Weight	Approx. 2 kg			Approx. 900 g			—			Approx. 730 g				

*1: Typical accuracy and ranges are shown. For details, please refer to each product page in this catalog.

*2: Ranges of each gauge pressure

*3: For the frequency, pulse source and measurement accuracy of the CA500/550, please refer to page 97.

*4: For the frequency, pulse source and measurement accuracy of the CA71, please refer to page 98.

*5: The loop power source function of the CA71 has different connection method from other models.



● Available

... P.100

... P.100

... P.101

... P.99

Item	Product Type/ Model	Volt mA Calibrator	TC Calibrator	RTD Calibrator	Process Multi Meter	
		CA310	CA320	CA330	CA450	
Source and measurement Form		Source or measurement Switching	Source or measurement Switching	Source or measurement Switching	Source or measurement Switching	
Source Function	DC voltage (DC voltage)	500 mV/5/30 V (0.015% of setting)	90 mV (0.015% of setting)	—	*8	
	DC current (DCmA)	20 mA (0.015% of setting)	—	—	25 mA (0.05% of setting)	
	DC current (mA SIMULATE)	20 mA (0.015% of setting)	—	—	25 mA (0.05% of setting)	
	Resistance (Ω)	—	—	500 Ω/3000 Ω (0.025% of setting)	—	
	Resistance temperature detector (RTD)	—	—	Pt100/JPt100/Pt200/Pt500/Pt1000/ Cu10/Ni120/Pt50/Pt50G/Pt100G/ Cu50M/Cu100M ⁷	—	
	Thermocouple (TC)	—	K/E/J/T/N/L/U/R/S/B/C/XK/A/D/G/ Platinel II ⁶	—	—	
	Frequency (Hz) Pulse (PULSE)	Output pulse setting	—	—	—	—
		Output voltage	—	—	—	—
Dry contact		—	—	—	—	
Measurement Function	AC voltage (AC voltage)	—	—	—	600 mV/6/60/600/1000 V (0.09% of reading)	
	DC voltage (DC voltage)	500 mV/5 V/30 V/50 V (0.015% of reading)	90 mV (0.015% of reading)	—	600 mV/6/60/600/1000 V (0.09% of reading)	
	DC current (DCmA)	20 mA/50 mA (0.015% of reading)	—	—	30/100 mA (0.05% of reading)	
	Resistance (Ω)	—	—	500/3000 Ω (0.025% of reading)	600 Ω/6/60/600 kΩ/6/60 MΩ (0.2% of reading)	
	Resistance temperature detector (RTD)	—	—	Pt100/JPt100/Pt200/Pt500/Pt1000/ Cu10/Ni120/Pt50/Pt50G/Pt100G/ Cu50M/Cu100M ⁷	—	
	Thermocouple (TC)	—	K/E/J/T/N/L/U/R/S/B/C/XK/A/D/G/ Platinel II ⁶	—	—	
	Frequency (Hz)	—	—	—	200 Hz/2 kHz/20 kHz (0.005% of reading)	
	Pulse (PULSE)	—	—	—	—	
	24 V loop power supply	●: 24 V ±1 V (communication resistance OFF) ●: 24 V ±6 V (communication resistance ON)	—	—	●: No regulations	
	Pressure	—	—	—	—	
General specifications/functions	Display	Segment LCD			Segment LCD	
	Source pattern	Step sweep	●: 15/30/45/60 seconds			●: 15/30/45/60 seconds
		Linear sweep	●: 15/30/45/60 seconds			●: 15/40 seconds
		Span check	●			●
		Program sweep	—			—
	Data memory	—			—	
	Communication interface	—			IR-USB	
	Power supply	Four alkaline AA batteries AC adapter (Sold separately)			Four alkaline AA batteries AC adapter (Sold separately)	
	Battery life (alkaline AA batteries)	Approx. 50 hours (5 V source load 10 kΩ or more) Approx. 25 hours (20 mA source load 5 V or less)	Approx. 55 hours		During measurement: approx. 140 hours During generation: approx. 10 hours	
	Dimensions Approx	90 (W) × 192 (H) × 42 (D) mm			90 (W) × 192 (H) × 49 (D) mm	
Weight	Approx. 440 g			Approx. 600 g		

*6: For the TC source and measurement accuracy of the CA320, please refer to page 102.

*7: For the RTD source and measurement accuracy of the CA330, please refer to page 103.

*8: The accuracy of the DC voltage source of the CA450 is not specified. Please use 99031 (1-5 V conversion set) for DC voltage source.

High Accurate and High Functional Pressure Calibrator Specially Designed for the Calibration of Differential Pressure and Pressure Transmitters.



See brochure for details: Bulletin CA700-EN

Features

- Achieves the highest accuracy in the portable class
Basic accuracy:
Pressure (measurement): 0.01% reading
Current/voltage (source/measurement): 0.015% reading
- Achieves the highest resolution and widest range in the portable class
0.001 kPa (200.000 kPa range)
- Strong support for field calibration and maintenance work
 - Calibration procedures of pressure transmitters and pressure switches are embedded.
 - “As Found”, “As Left” data and error rate (%) can be recorded.
- IP54 dustproof and waterproof robust case enables use in harsh environments.
- Three high-performance hand pump models for different pressure ranges are available.
- Pressure calibration in the high pressure range is possible with external pressure sensor PM100 connection.



PM100

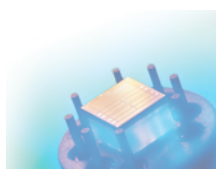

Silicon resonant sensor

Applications

Supports Various Applications

Field Calibration of Differential Pressure and Pressure Transmitters

Calibration of pressure transmitters is required to accurately measure the input and output values and to calculate the error rate.

The CA700 ensures reliable calibration with its function to accurately measure the input and output values of pressure and current. Additionally its embedded calibration procedures enable users to perform certain calibration following the prescribed procedure.

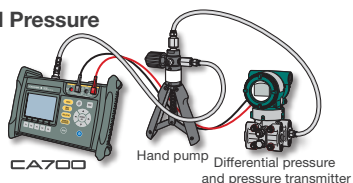

CA700

Hand pump Differential pressure and pressure transmitter

Pressure Switch Test

A pressure switch test measures the pressure at the time when the contact opens and closes and the resistance at the time when the

dead band contact closes. A test procedure is embedded to enable users to carry out a test following the prescribed procedure.

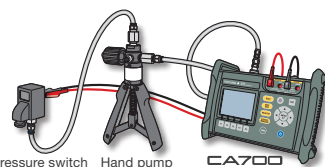

Pressure switch Hand pump CA700

Check and I/O Adjustment of an Electro-pneumatic Converter

Input and output adjustment of an electro-pneumatic converter is carried out by applying rising and falling currents of 0, 25, 50, 75, and 100% of the span.

A reliable test can be carried out with the CA700 that has a 4-20 mA step function for signal generation and a capability to accurately measure the generated pressure.

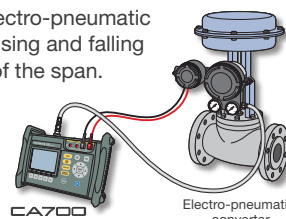

CA700 Electro-pneumatic converter

20 mA SIMULATE (Two-wire Transmitter Simulator)

The CA700 can also be used as a transmitter simulator to carry out a loop test. It can absorb (SINK) the set current from an external voltage

generating device (e.g., a distributor system or PLC) of instrumentation equipment. 4-20 mA current can be sourced with an accuracy of 0.015% of the reading.

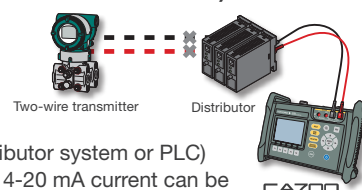

Two-wire transmitter

Distributor

CA700

Two-wire Transmitter Loop Check

DC mA signals can be measured by supplying power to the transmitter from a 24 V DC power supply.

DC mA signal measurement and zero-point check can be performed with an accuracy of 0.015% of the reading. A 250-ohm resistor for HART and BRAIN communication is included in this calibrator so there is no need to attach an external resistor when connecting to a handy terminal.

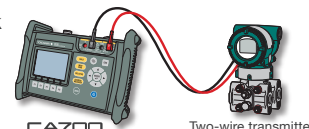

CA700

Two-wire transmitter

Input Command Check and Adjustment of Recorders and Controllers

Instrumentation loop test and operation/command check can be performed by sourcing DC 1-5 V/4-20 mA instrumentation signals with an accuracy of 0.015% of the reading.

Furthermore, two patterns of linear sweep and step sweep can be selected (the sweep time can be specified from 15, 30, 45, and 60 s).

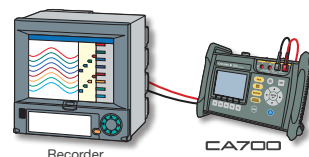

Recorder

CA700

Related Product

Mobile Field Device Management FieldMate

Features

- Support Universal Communication Protocol & Other Vendors' Devices (BRAIN, FOUNDATION™, Fieldbus H1, HART®, ISA100.11a)
- Control the Pressure Calibrator CA700 remotely
- Include the calibration procedure of a pressure/Differential Pressure/Pressure Transmitter
- Provide automatic recording of calibration data, calculation of relative error and pass/fail determination
- Improve work efficiency by the automatic generation function of the test report (The report format can be selected from text, web browser or template.)

*FieldMate is provided by YOKOGAWA. Please refer to the URL below for further details.
<http://www.yokogawa.com/fieldmate/>



FieldMate

Smart Calibration of CA700 and FieldMate Differential Pressure/Pressure Transmitter

FieldMate is PC and tablet based software for adjusting, setting and managing devices. It systematizes a series of work from field calibration of a pressure/differential pressure transmitter to report generation in combination with the Pressure Calibrator CA700. They achieve speedy, highly efficient field calibration by offering calculation of relative error, pass/fail determination and report generation as well as automatic recording of device information and calibration data. Recorded calibration data can be registered in FieldMate's database (device maintenance information) along with other maintenance information. Analysis of accumulated device maintenance information and calibration data is useful for estimation/decision of deterioration diagnosis and device replacement of pressure/differential pressure transmitters.



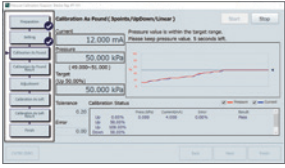

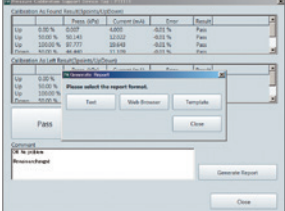

Calibration support screen

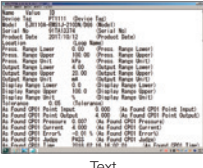

Report output screen



Text



Web browser



Template



For maintenance information management
FieldMate

Calibration support by remote operation

CA700 Hand Pump Differential pressure and pressure transmitter

FieldMate Device information acquisition device setting/adjustment

Specifications

Basic Specifications (Measurement Unit) 23°C±3°C

Pressure Measurement

Model	CA700-E-01	CA700-E-02	CA700-E-03
Pressure type	Gauge	Gauge	Gauge
Measurement range			
Positive pressure	0 to 200 kPa	0 to 1000 kPa	0 to 3500 kPa
Negative pressure	-80 to 0 kPa	-80 to 0 kPa	-80 to 0 kPa
Measurement display range	To 240,000 kPa	To 1200.00 kPa	To 4200.00 kPa
Resolution	0.001 kPa	0.01 kPa	0.01 kPa
Measurement accuracy (6 months after calibration) (Tested after zero calibration)			
Positive pressure	20 to 200 kPa: ±(0.01% of reading + 0.003 kPa) 0 to 20 kPa: ±0.005 kPa	±(0.01% of reading + 0.04 kPa)	±(0.01% of reading + 0.15 kPa)
Negative pressure	±(0.2% of reading + 0.080 kPa)	±(0.2% of reading + 0.08 kPa)	±(0.2% of reading + 0.08 kPa)
Input port	Rc 1/4 or 1/4 NPT female thread (selectable)		
Measurement unit material	Diaphragm: Hastelloy C276 and input port: SUS316		

DC Current Measurement

Range	Resolution	Measurement range	Measurement accuracy (1 year)	Remark
20 mA	1 μA	0 to ±20,000 mA	0.015% of reading + 3 μA	Input resistance: 10 Ω or less. The maximum display is 1.2-fold of range.
100 mA	10 μA	0 to ±100.00 mA	0.015% of reading + 30 μA	

DC Voltage Measurement

Range	Resolution	Measurement range	Measurement accuracy (1 year)	Remark
5 V	0.1 mV	0 to ±5,000.0 V	0.015% of reading + 0.5 mV	Input resistance: approx. 1 MΩ. The maximum display is 1.1-fold of range.
50 V	1 mV	0 to ±50,000.0 V	0.015% of reading + 5 mV	

24 V Loop Power Supply

Supply voltage	Remark
24 V ±1 V	Load current 24 mA when communication resistance OFF
24 V ±6 V	Load current 20 mA when communication resistance ON

Basic Specifications (Generation Unit) 23°C±3°C

DC Current Source

Range	Resolution	Source range	Accuracy (1 year)	Remark (when communication resistance OFF)
20 mA	1 μA	0 to 20,000 mA	0.015% of setting + 3 μA	Compliance voltage: 24 V. The maximum setting is 1.2-fold of range. External power supply: 5 to 28 V. The maximum setting is 1.2-fold of range.
20 mA SIMULATE	1 μA	0 to 20,000 mA	0.015% of setting + 0.5 mV	

DC Voltage Source

Range	Resolution	Source range	Accuracy (1 year)	Remark
5 V	0.1 mV	0 to 5,000.0 V	0.015% of setting + 0.5 mV	Load resistance: 5 kΩ or more. The maximum setting is 1.1-fold of range.

General Specifications

Display	Dot matrix LCD (320 × 240 dots)
Backlight	LED
Display refresh rate	Approx. 300 ms (3 times/s)
Warm-up time	Approx. 5 minutes
Power supply	Six alkaline AA batteries
Battery life	Approx. 35 hours when measuring current with the 24 V loop power supply OFF and approx 10 hours with the 24 V loop power supply ON
Auto power-off	Approx. 60 minutes (the function can be disabled)
Insulation resistance	100 MΩ or more (500 VDC) between the input terminal and case and between the input port and case
Withstand voltage	500 VAC for 1 minute between the input terminal and case and between the input port and case
Protection grade	IP54 dustproof and waterproof structure
Dimensions	Approx. 264 (W) × 188 (H) × 96 (D) mm, excluding protrusions
Weight	Approx. 2 kg (including batteries)
Compliance standards	Safety: EN61010-1, EN61010-2-030, contamination class 2 EMC: EN61326-1 Class A, EN55011 Class A Group 1
Operating temperature/humidity ranges	-10 to 50°C and 20 to 80%RH (no condensation)
Storage temperature/humidity ranges	-20 to 60°C and 20 to 80%RH (no condensation)
Interfaces	Select and switch between USB A mass-storage device, USB mini-B communication device class, and mass storage class
External sensor	A dedicated external sensor can be connected via a connector. (Planned to be released in the future)
Accessories ^{*1}	A set of 1.7 m long black and red lead wires with alligator clips for generation and measurement, six alkaline AA batteries, R1 1/4" – 1/8" NPT female thread × 1, ferrite core × 2, R 1/4" – 1/4" NPT female thread × 1, accessory case, instruction manual (CD), startup guide, shoulder strap

*1: The type of the included conversion connector varies depending on the suffix code (-P1 and -P2). For details, refer to "CA700 Accessories" on this page.

Model and Suffix Code

Model	Suffix Code	Description
CA700		CA700 Pressure Calibrator General use type
	-E	All countries except Japan
	-01	Gauge pressure: 200 kPa
	-02	Gauge pressure: 1000 kPa
	-03	Gauge pressure: 3500 kPa
	-U1	Metric units *Only kPa, Pa, hPa, MPa, mbar, bar, atm are available.
	-U2	Metric units and non-metric units
	-P1	Rc 1/4" female thread
	-P2	1/4" NPT female thread

Separately Sold Accessories^{*1}

Model	Product Name	Description
93050	Carrying Case	Bag for the calibrator, accessories, and peripheral devices
98026	Grabber Clip	A set of separate red and black clips (for 2 m long wires)
91040	Cleaning Unit ^{*2}	Can connect to -P1 or -P2, input and output port are Rc1/8" female thread
91041	Cleaning Unit ^{*2}	Can connect to -P1 or -P2, input and output port are 1/8" NPT female thread

*1: These accessories are not included in the CA700 calibrator package.

*2: Available to clean the pressure sensor of main unit (CA700) after liquid pressure measurement.

CA700 Accessories^{*1}

Model	Product Name	Description
91080	Connector ^{*2}	R 1/4" male thread to 1/8" NPT female thread conversion connector (for -P1)
91081	Connector ^{*2}	R 1/4" male thread to 1/4" NPT female thread conversion connector (for -P1)
91082	Connector ^{*3}	1/4" NPT male thread to 1/8" NPT female thread conversion connector (for -P2)
98064	Lead Wires for Source/Measurement	Red and black alligator clip lead wires, 1.7 m long
B9108XA	Accessory Bag	For lead wires and connector

*1: Included in the CA700 calibrator package at the time of purchase. *2: Included in the package when suffix code -P1 is selected. *3: Included in the package when suffix code -P2 is selected.

External Pressure Sensor PM100 (70 MPa Range) Pressure Measurement up to 70 MPa with the CA700!



See brochure for details: LF PM100-01EN



Features

- The highest measurement accuracy in field type
Basic accuracy: 0.01% of reading
- The highest resolution in class
0.0001 MPa is achieved in each range
- Multi range (Three pressure ranges in one unit)
7 MPa/10 MPa/16 MPa (-05)
25 MPa/50 MPa/70 MPa (-06)

Applications

Field calibration of pressure transmitter

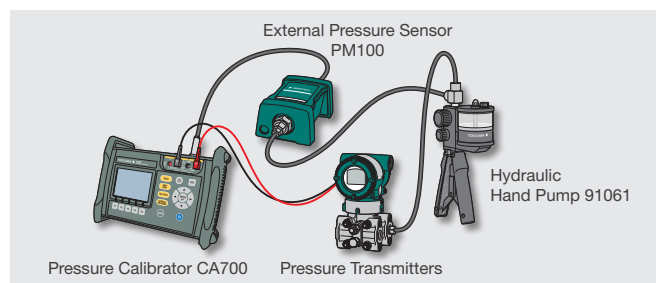

Specifications

Basic Specifications

16 MPa Model (-05) [Pressure type: Shield gauge]

Measurement Range	0 to 7 MPa sg	0 to 10 MPa sg	0 to 16 MPa sg
Measurement display range	to 8.4000 MPa	to 12.0000 MPa	to 19.2000 MPa
Measurement accuracy ^{*1, *2}	6 ⁺ 3 months after calibration (Test after zero calibration) ^{*3}	±(0.01% of reading + 2 kPa)	±(0.01% of reading + 3 kPa)
	1 ⁺ 4 year after calibration (Test after zero calibration) ^{*5}	±(0.01% of reading + 2.8 kPa)	±(0.01% of reading + 3.8 kPa)
Allowable input	2.7 kPa abs to 23 MPa sg		
Temperature coefficient	±(0.001% of reading + 0.16 kPa) / °C or less		

70 MPa Model (-06) [Pressure type: Shield gauge]

Measurement Range	0 to 25 MPa sg	0 to 50 MPa sg	0 to 70 MPa sg
Measurement display range	to 30.0000 MPa	to 60.0000 MPa	to 77.0000 MPa
Measurement accuracy ^{*1, *2}	6 ⁺ 3 months after calibration (Test after zero calibration) ^{*3}	±(0.01% of reading + 6 kPa)	±(0.01% of reading + 10 kPa)
	1 ⁺ 4 year after calibration (Test after zero calibration) ^{*5}	±(0.01% of reading + 9.5 kPa)	±(0.01% of reading + 13.5 kPa)
Allowable input	2.7 kPa abs to 98 MPa sg		
Temperature coefficient	±(0.001% of reading + 0.7 kPa) / °C or less		

Common Specifications

Resolution	0.0001 MPa (0.1 kPa)
Response time ^{*6}	2.5 s or less
Internal volume	Approx. 6 cm ³
Influence of positional setup	Zero point drift ±1 kPa or less
Measurement fluid	Gas and liquid (non-corrosive, non-flammable, non-explosive, and non-toxic fluids)
Measurement fluid temperature	-10 to 50°C (Liquid temperature 5 to 50°C)
Pressure sensor	Silicon resonant sensor
Pressure sensor element	Diaphragm
Input port	1/2 NPT female thread
Measurement unit material	Diaphragm: Hastelloy C276 and input port: SUS316

*1: Yokogawa's pressure standard accuracy is excluded
 *2: The value measured with the PM100 is in digital communication with the CA700, and there is no error between these instruments.
 *3: 23°C±3°C, 6 months after calibration, Test after zero calibration
 *4: 23°C±3°C, 1 year after calibration, Test after zero calibration
 *5: Zero-point calibration condition: Under atmospheric pressure
 *6: Time from 3.5 MPa to atmospheric release and from 0 MPa to ±3.5 kPa

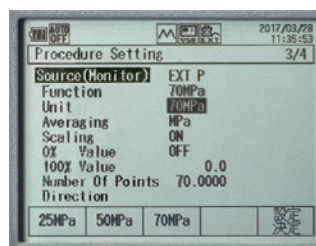

Setting screen

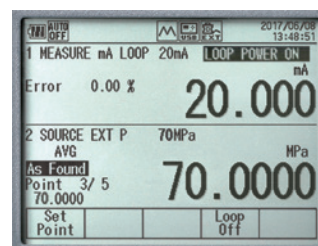

Measurement screen

General Specifications

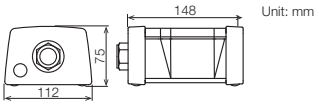
Warm-up time	Approx. 5 minutes						
Protection grade	IP54 dustproof and waterproof structure						
Dimensions	Approx. 112 (W) × 75 (H) × 148 (D) mm  Unless otherwise specified, the dimensional tolerance is ±3% (but less than 10 mm is ±0.3 mm).						
Weight	Approx. 1.2 kg						
Conforming Standards	Safety: EN61010-1 (contamination class 2) EMC: EN61326-1 Class A, EN55011 Class A Group1						
Operating temperature/humidity range	-10 to 50°C, 20 to 80% (no condensation)						
Storage temperature/humidity range	-20 to 60°C, 20 to 80% (no condensation)						
Accessories	<table border="1"> <tr> <td>Common to PM100</td> <td>Connection cable (1 m, Waterproof connector) 91083 (1/2" NPT male thread to 1/8" NPT female thread)</td> </tr> <tr> <td>When -05 is selected</td> <td>91084 (1/2" NPT male thread to 1/4" NPT female thread) 91085 (1/2" NPT male thread to Rc 1/4" female thread)</td> </tr> <tr> <td>When -06 is selected</td> <td>91086 (1/2" NPT male thread to 1/4" NPT female thread) 91087 (1/2" NPT male thread to Rc 1/4" female thread)</td> </tr> </table>	Common to PM100	Connection cable (1 m, Waterproof connector) 91083 (1/2" NPT male thread to 1/8" NPT female thread)	When -05 is selected	91084 (1/2" NPT male thread to 1/4" NPT female thread) 91085 (1/2" NPT male thread to Rc 1/4" female thread)	When -06 is selected	91086 (1/2" NPT male thread to 1/4" NPT female thread) 91087 (1/2" NPT male thread to Rc 1/4" female thread)
Common to PM100	Connection cable (1 m, Waterproof connector) 91083 (1/2" NPT male thread to 1/8" NPT female thread)						
When -05 is selected	91084 (1/2" NPT male thread to 1/4" NPT female thread) 91085 (1/2" NPT male thread to Rc 1/4" female thread)						
When -06 is selected	91086 (1/2" NPT male thread to 1/4" NPT female thread) 91087 (1/2" NPT male thread to Rc 1/4" female thread)						

Model and Suffix Code

Model	Suffix Code	Description
PM100		PM100 External Pressure sensor General use type
	-E	All countries except Japan
	-05	Shield gauge Pressure (7 MPa/10 MPa/16 MPa Range switching)
	-06	Shield gauge Pressure (25 MPa/50 MPa/70 MPa Range switching)
	-P3	1/2" NPT female thread

PM100 Accessories

Model	Product Name	Description
95020	Connection cable	1 m
91083	Connector	1/2" NPT male thread to 1/8" NPT female thread conversion connector
91084	Connector	1/2" NPT male thread to 1/4" NPT female thread conversion connector (when -05 is selected)
91085	Connector	1/2" NPT male thread to Rc1/4" female thread conversion connector (when -05 is selected)
91086	Connector	1/2" NPT male thread to 1/4" NPT female thread conversion connector (when -06 is selected)
91087	Connector	1/2" NPT male thread to Rc1/4" female thread conversion connector (when -06 is selected)

Source and Measure In-Field with High Confidence



See brochure for details: Bulletin CA500-01EN



Portable and Handheld Instruments

Features

- **High Accuracy**
 - CA550 0.010% (DCmA) /0.020% (Ω) /0.3°C (RTD)
 - CA500 0.015% (DCmA) /0.015% (Ω) /0.1°C (RTD)
- **Multi-function**
 - Sources and measures DC voltage, DC current, RTD, TC, resistance, frequency and pulse signals
 - Corresponds to 17 types of TC standard (JIS/IEC/DIN/ASTM/GOST R)
 - Corresponds to 14 types of RTD standard (JIS/IEC/GOST R)
- **Multiple source patterns**
 - Linear sweep function
 - Step sweep function
 - Program sweep function
- **Thin design x Robustness**
 - Thin body that is easy to hold with one hand, and improved robustness with protection

Functions

Easy-to-view Display

CA500 features a Reflective LCD, providing improved outdoor visibility. Main display (generated/measured values) and Sub display (% , mV, Ω, etc.) allow required information at a work site to be confirmed at a glance.



Wiring information display function

A wiring diagram is displayed according to the function selected. This function allows a user to perform wiring while referring to a wiring diagram and prevents mis-wiring.



Thermocouple generation using TC Mini Plug

Using a TC Mini Plug together with a compensating lead wire enables generation of thermal electromotive force without an external RJ sensor.*

*A compensating lead wire needs to be prepared by customer.



Easy-to-use key operation

0%/100% keys

The source can be easily switched between 0% and 100% of range. Users can also set a desired value.



UP/DOWN keys

The output is changed in preset steps by pressing UP or DOWN key.

Operation key layout

Keys related to generation and measurement are arranged collectively to allow easy and intuitive operation.

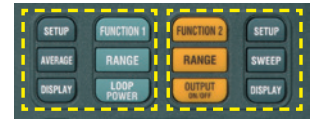

SQUARE ROOT output

For 4-20 mA, 1-5 V ranges, users can choose between LINEAR and SQUARE ROOT output.

	Current		Voltage	
	LINEAR	SQUARE ROOT	LINEAR	SQUARE ROOT
0%	4 mA	4 mA	1 V	1 V
25%	8 mA	5 mA	2 V	1.25 V
50%	12 mA	8 mA	3 V	2 V
75%	16 mA	13 mA	4 V	3.25 V
100%	20 mA	20 mA	5 V	5 V

Actual output values

CA550 Only Automatic input/output testing (Program sweep)

Automatic input/output testing is possible by setting source values for each step for a calibration target. Calibration results such as generated value, measured value, error rate, date/time, and pass/fail are saved in CSV format in the CA550 main unit. By connecting the CA550 to a PC using a standard USB cable, the instrument can be recognized as a mass-storage device for data to be transferred to the PC.

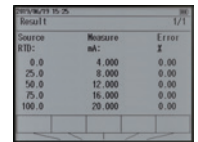
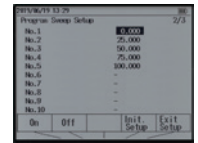

CA550 Only HART COMMUNICATION PROTOCOL

HART communication function¹ HART/BRAIN modem function¹
BRAIN TagNo acquisition function²

¹ when CA550-F2 or -F3 is specified. ² when CA550-F2 is specified.

The following items are supported by HART communication function:

• TagNo.	Read	Please note that not all commands are supported by HART communication. TagNo acquisition function is available in BRAIN communication. No other functions are available.
• PV value (including reading of PV %value, AO value, SV value, TV value, QV value)	Read	
• LRV (Lower limit of range)	Read and Write	
• URV (Upper limit of range)		
• Damping	Write	
• Trim D/A at 4 mA		
• Trim D/A at 20 mA		
• PV Zero		

Applications

CA500/CA550 application examples

20 mA SIMULATE

The CA500 series can be used as a transmitter simulator to perform a loop test. It sinks the set current from an external voltage source of instrumentation equipment.

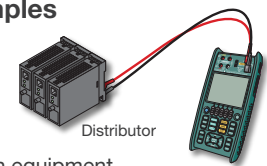

Zero point adjustment of HART transmitter

CA550 supports HART communication (Universal command/Common practice command). Reading of HART device information, writing of LRV/URV, and trimming of analog output are possible.

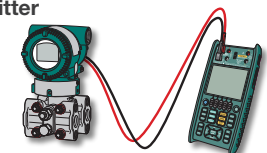

RTD SIMULATE

CA500/CA550 corresponds to 14 types of RTD for sourcing. It achieves the high basic accuracy of 0.1°C* (typical of type Pt100), which enables it to operate a highly reliable test. Additionally, input and output testing of temperature transmitters is possible at the same time. *Accuracy for CA550

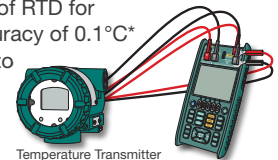

Specifications

Voltage/Current/Resistance/Pulse Source Unit

Function	Range	Resolution	Source range	Accuracy (1 year) ±(% of Setting + offset)		Note
				CA500	CA550	
DC voltage	100 mV	1 μV	±110.000 mV	0.015% + 10 μV	0.015% + 5 μV	Maximum output current: 10 mA
	1-5 V	0.1 mV	0.0000 to 6.0000 V	0.015% + 0.5 mV		Maximum output current: 10 mA Value output function supporting square root computation is available
	5 V	0.1 mV	±6.0000 V	0.015% + 0.5 mV		Maximum output current: 10 mA
	30 V	1 mV	±33.000 V	0.015% + 5 mV		Maximum output current: 1 mA
DC current	20 mA	1 μA	±24.000 mA	0.015% + 3 μA	0.010% + 2 μA	Source voltage: 0 to +20 V
	4-20 mA	1 μA	0.000 to 24.000 mA	0.015% + 3 μA	0.010% + 2 μA	Source voltage: 0 to +20 V Value output function supporting square root computation is available
	20 mA SIMULATE	1 μA	0.000 to 24.000 mA	0.015% + 3 μA	0.010% + 2 μA	External power supply: +5 to +28 V
Resistance	400 Ω	10 mΩ	0.00 to 440.00 Ω	0.020% + 0.1 Ω ¹	0.015% + 0.05 Ω ¹	Allowable measurement current: 0.1 to 3 mA
	4000 Ω	100 mΩ	0.0 to 4400.0 Ω	0.020% + 0.5 Ω ¹	0.015% + 0.2 Ω ¹	Allowable measurement current: 0.05 to 0.6 mA
Frequency /pulse ⁴	500 Hz	0.01 Hz	1.00 to 550.00 Hz	0.005% + 0.01 Hz		Square wave, 50% Duty Cycle, +0.1 to +15 V Pulse number: Continuous 1 to 99999 cycles Maximum load current: 10 mA
	5000 Hz	0.1 Hz	1.0 to 5500.0 Hz	0.005% + 0.1 Hz		
	50 kHz	0.001 kHz	0.001 to 50.000 kHz	0.005% + 0.001 kHz		
	CPM	0.1/min	1.0 to 1100.0/min	0.5/min		

Voltage/Current/Resistance/Pulse Measurement Unit

Function	Range	Resolution	Measurement range	Accuracy (1 year) ±(% of reading + offset)		Note
				CA500	CA550	
DC voltage	100 mV	1 μV	±110.000 mV	0.015% + 10 μV	0.015% + 5 μV	Input resistance: 1 GΩ or more
	5 V	0.1 mV	±6.0000 V	0.015% + 0.5 mV		Input resistance: Approx. 1 MΩ
	50 V	1 mV	±55.000 V	0.015% + 5 mV		Input resistance: Approx. 1 MΩ
DC current	50 mA	1 μA	±60.000 mA	0.015% + 3 μA	0.010% + 2 μA	Input resistance: 10 Ω or less
Resistance	400 Ω	10 mΩ	0.00 to 440.00 Ω	0.020% + 0.1 Ω ²⁻³	0.015% + 0.05 Ω ²⁻³	Voltage applied current measurement method (typical 1 mA@0 Ω, 781 μA@400 Ω, 240 μA@4 kΩ)
	4000 Ω	100 mΩ	0.0 to 4400.0 Ω	0.020% + 0.5 Ω ²⁻³	0.015% + 0.2 Ω ²⁻³	
Pulse measurement ⁴	500 Hz	0.01 Hz	1.00 to 550.00 Hz	0.005% + 0.01 Hz		Measurement time: 1.0 s (Max. 10 s), 0.5 V to 30 Vpp
	5000 Hz	0.1 Hz	1.0 to 5500.0 Hz	0.005% + 0.1 Hz		
	50 kHz	0.001 kHz	0.001 to 50.000 kHz	0.005% + 0.001 kHz		
	PULSE COUNT	1	0 to 99999	2		
						Maximum integration time: 60 min, 0.5 V to 30 Vpp

Accuracy is guaranteed under the environmental conditions of +23°C±5°C, 20 to 80% RH. For use in the temperature range of -10 to +18°C or +28 to +50°C, add the temperature coefficient: 0.005% of Range/°C.

¹ When using the included binding post (#9045)

² Above accuracy is defined for 4 wire measuring.

³ Accuracy for 3 wire measuring: 0.05Ω to 400 Ω range; 0.2 Ω to 4000 Ω range is added, on condition the resistance of all cables are the same.
Accuracy for 2 wire measuring: Same with 3 wire measuring on condition the resistance of cables are excluded.

⁴ Dry contact compatible

24 V Loop Power Supply

Supply voltage	24 V±2 V
Note	Communication resistance: OFF, Maximum load current: 24 mA

General Specifications

Function	CA500	CA550
Display	Monochrome Dot Matrix LCD	
Built-in light	Selection of "Constantly ON", "Constantly OFF" or "Auto off by approx. 10 min" OFF, level dimming function	
Display refresh rate	Approx. 1 s	
Warm-up time	Approx. 5 min	
Language	English (default setting), Japanese, Chinese, Korean, Russian	
Power supply	DC 5 V±10%, max. 500 mA, Four alkaline AA batteries, Battery life: Approx. 16 hours (Measurement ON, 5 V output/10 kΩ or more)	
Auto power-off	Approx. 30 minutes (disabled by default)	
Ground voltage	Measurement terminal: 50 V, Source terminal: 30 V	
Insulation resistance	Between FUNCTION1-2 terminals: DC 500 V 50 MΩ or more	
Withstand voltage	Between FUNCTION1-2 terminals: 500 V AC for 10 seconds	
Dimensions	Approx. 130 (W) × 260 (H) × 53 (D) mm	
Weight	Approx. 900 g (including batteries)	
Safety standard	EN61010-1, Overvoltage Category I, Pollution Degree 2 EN61010-2-030, Measurement category O (other)	
Operation environment	Temperature: -10 to +50°C, Humidity: 80%R.H. (40°C or less), 50%R.H. (40 to 50°C) *No condensation, Altitude: 2000 m or less	
Storage environment	Temperature: -20 to +60°C, Humidity: 90%R.H. (No condensation)	
Interface	USB B communication device class	USB B communication device class, USB B mass storage class
Application	-	HART communication mode
Number of Data Records	Up to 100 results	Up to 250 CSV files
Accessories	Source lead cables, Measurement lead cables, Binding post (2 sets), USB cable (2 m, USB Type A - USB Type B), Soft case (for accessories), four AA alkaline batteries, Instruction manual (CD), Startup guide, Shoulder strap	

Model and Suffix Code

Model	Suffix Code	Description
CA500	-F1	Multi-function Process Calibrator No communication function
CA550	-F2	HART/BRAIN function
	-F3	HART function
Option	/TE	Add deg F setting procedure

Accessories¹

Model	Product Name	Description
98020	Lead cable for source	1 red, 2 black, 1.7 m 7 mm fork terminal to alligator clip
98035	Source/measurement lead cable	3 red, 1 black 1.7 m L plug terminal to alligator clip
99045	Binding Post (Red Black)	1 short plate attached ²
99046	Binding Post (Red Red)	1 short plate attached ²
A1421WL	USB Cable	USB Type A to Type B, 2 m
B8080FQ	Soft Case	Soft case for accessories

¹ Included with the CA500/CA550 main unit.
² The short plate is not used on CA500/CA550 (common parts with the CA300 series).

Accessories (sold separately)

Model	Product Name	Description
98064	Lead cables	1 red, 1 black, 1.7 m L plug terminal to alligator clip
90080	RJ Sensor ¹	Pt100 JIS AA class or equivalent
98026	Grabber Clip	1 red-black pair, 2 m, separate type
SU2006A	Soft carrying case	For CA500/CA550 main unit
90045	TC Mini Plug Set 2 ²	K (yellow)/ E (violet)/ J (black)/ T (blue)
90046	TC Mini Plug Set 3 ²	K (yellow)/ E (violet)/ J (black)/ T (blue)/ R•S (green)/ B•U (white)/ G (red, green)/ N (orange)
93026	Carrying case	CA500/CA550 main unit, Source/measurement lead cable, Binding post, For USB cable storage

¹ RJ sensor is dedicated to CA500/550/320, unable to be used with CA71 and CA150.
² Other types of mini plugs and a compensating lead wire need to be prepared by customer.

Simultaneous Signal Source and Measurement Capability



See brochure for details: Bulletin CA71E



Portable and Handheld Instruments

Features

- Multiple source and measurement of voltage, current, resistance, thermocouple, resistance temperature detector, frequency and pulse. (temperature measurement: CA71 only)
- The rotary switch enables easy operation like a DMM.
- Source and measurement (count) of dry contact pulse is available.
- Various source patterns such as the functions of divided output, auto-step and sweep.
- Two-way power source of batteries and an AC adapter (sold separately)

Functions

- Divided output (n/m) function
- Sweep function
- Equivalent output of TC and RTD
- Internal reference junction compensation sensor
- 20 mA SINK function
- Communication function (RS232) (CA71 only)
- Voltage pulse and contact pulse
- CPM (count/minute) and CPH (count/hour)
- Auto-step function
- Memory function (50 data)

Applications

CA71 application examples

Connection with device supporting three-wire RTD thermometer

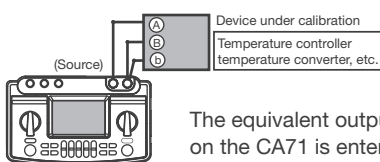

This is an example of connection with a device used as a three-wire RTD thermometer.

The equivalent output of the temperature set on the CA71 is entered to the device under calibration. At this point, wiring three wires

is necessary to cancel the cable resistance of the lead cable connecting the CA71 and the target device.

Input and output test of distributor with 20 mA SINK

This is an example of connection with a distributor used as a two-wire transmitter.

The CA71 sinks the current of supply voltage up to 28 V and checks the loop circuit. (It uses the 20 mA SINK range.)

In addition, it can measure the output value of the distributor at the same time.

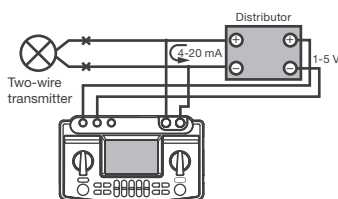

Specifications

Source Unit Accuracy: \pm (% of setting + μ V, mV, mA, Ω or $^{\circ}$ C)

Range	Accuracy (23 \pm 5 $^{\circ}$ C/1 year)	Resolution
DC voltage		
100 mV	\pm (0.02 % + 15 μ V)	10 μ V
1 V	\pm (0.02 % + 0.1 mV)	0.1 mV
10 V	\pm (0.02 % + 1 mV)	1 mV
30 V	\pm (0.02 % + 10 mV)	10 mV
DC current		
20 mA	\pm (0.025 % + 3 μ A)	1 μ A
4-20 mA	\pm (0.025 % + 3 μ A)	4 mA
mA SINK	\pm (0.05 % + 3 μ A)	1 μ A
Resistance	\pm (0.025 % + 0.1 Ω)	0.01 Ω
RTD	Pt100/JPt100 \pm (0.025 % + 0.3 $^{\circ}$ C)	0.1 $^{\circ}$ C
TC		
K/E/J	\pm (0.02 % + 0.5 $^{\circ}$ C) (-100° C or greater) \pm (0.02 % + 1 $^{\circ}$ C) (-100° C or less)	0.1 $^{\circ}$ C
T/N/L/U	\pm (0.02 % + 0.5 $^{\circ}$ C) (0° C or greater) \pm (0.02 % + 1 $^{\circ}$ C) (0° C or less)	1 $^{\circ}$ C
R/S	\pm (0.02 % + 1.5 $^{\circ}$ C) (100° C or greater) \pm (0.02 % + 2.5 $^{\circ}$ C) (100° C or less)	
B	\pm (0.02 % + 1.5 $^{\circ}$ C) (1000° C or greater) \pm (0.02 % + 2 $^{\circ}$ C) (1000° C or less)	
Frequency/pulse		
500 Hz	\pm 0.2 Hz	0.1 Hz
1000 Hz	\pm 1 Hz	1 Hz
10 kHz	\pm 0.1 kHz	0.1 kHz
Pulse cycle	—	1 cycle

Measurement Unit Accuracy: \pm (% of reading + μ V, mV, mA, Ω , $^{\circ}$ C or digit)

Range	Accuracy (23 \pm 5 $^{\circ}$ C/year)	Resolution
DC voltage		
100 mV	\pm (0.025% + 20 μ V)	10 μ V
1 V	\pm (0.025% + 0.2 mV)	0.1 mV
10 V	\pm (0.025% + 2 mV)	1 mV
100 V	\pm (0.05% + 20 mV)	0.01 V
DC current		
20 mA	\pm (0.025% + 4 μ A)	1 μ A
100 mA	\pm (0.04% + 30 μ A)	10 μ A
Resistance	\pm (0.05% + 0.1 Ω)	0.01 Ω
AC voltage		
1 V	\pm (0.5% + 5 digit)	1 mV
10 V		0.01 V
100 V		0.1 V
300 V		1 V
Frequency/pulse		
100 Hz	\pm 2 digit	0.01 Hz
1000 Hz		0.1 Hz
10 kHz		0.001 kHz
CPM		1 CPM
CPH	—	1 CPH
TC (CA71 only)		
K/E/J/T/N/L/U	\pm (0.05% + 1.5 $^{\circ}$ C) (-100° C or greater) \pm (0.05% + 2 $^{\circ}$ C) (-100° C or less)	0.1 $^{\circ}$ C
R/S/B	\pm (0.05% + 2 $^{\circ}$ C) (100° C or greater) \pm (0.05% + 3 $^{\circ}$ C) (100° C or less)	1 $^{\circ}$ C
RTD (CA71 only)	Pt100/JPt100 \pm (0.05% + 0.6 $^{\circ}$ C)	0.1 $^{\circ}$ C

General specifications

Source unit response time	Approx. 1 second (The amount of time from the output starts changing to enters within the accuracy)
Source unit voltage limiter	Approx. 32 V
Source unit current limiter	Approx. 25 mA
Measurement unit max. input	Voltage terminal: DC/AC 300 V, Current terminal: 120 mA
Current terminal input protection	Fuse: 100 mA/400 V
Measurement unit voltage to ground	Max. 300 V
Measurement display update rate	Approx. 1 time/second
Serial interface (CA71 only)	Available with connecting a communication cable (RS232): Sold separately as an accessory
Power supply	Four alkaline AA batteries (LR6) or a dedicated AC adapter (8.5 V/150 mA: sold separately)
Conforming standards	Safety standards EN61010-1, EN61010-2-030, EN61010-2-033, Measurement category III 300 V, Lead cables for measurement (RD031): EN61010-031, Indoor use, Operating altitude 2000 m or less, Pollution degree 2
	EMC standards EN61326-1 Class A, EMC Regulatory Arrangement in Australia and New Zealand, EN 55011 ClassA Group1, Korea Electromagnetic Conformity Standard
Withstand voltage	Between input and output terminals 3.7 kVAC 1 minutes
Operating temperature and humidity ranges	0 to 50 $^{\circ}$ C, 20 to 80% RH (no condensation)
Weight	Approx. 730 g (including batteries)

Model and Suffix Code

Model	Suffix Code	Description
CA71		CA71 Handy Calibrator
CA51		CA51 Handy Calibrator

Loop Power and 4 to 20 mA Output Function in a DMM



See brochure for details: Bulletin CA450-E



Features

- Simultaneous 24 V loop power and mA measurement
- HART/BRAIN mode setting with loop power (Adds 250 ohm resistance internally)
- SIMULATE (SINK) function simulates transmitters
- 4-20 mA span/step/auto-step/sweep output
- High accuracy signal measurement: DC mA 0.05%/30.000 mA
- Handheld DMM function
- Dedicated sensor modes for direct reading of many sensor signal types
- Measurement categories 600 V CAT. IV, 1000 V CAT. III
- DMM Communication Package can be used to save and manage the measurement data.

Functions

Step generation function

The step can be generated by increasing or decreasing the step between 0 and 20 mA or between 4 and 20 mA in increments of 25% up to 100% with one touch, or stepwise automatically (step width is selectable) to improve work efficiency. The Slow mode of Step Mode can also be used to change the step time in accordance with the performance of field devices.

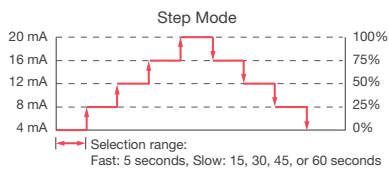

Applications

CA450 application examples

Loop check function

The CA450 has a loop power supply function to supply 24 VDC/20 mA DC. It can output 4 to 20 mA to drive the two-wire transmitter.

- High-precision signal measurement
- Range: 30.000 mA DC • Accuracy: 0.05%
- HART and BRAIN communications are facilitated by connecting a communicator using the HART mode resistance (250 Ω).

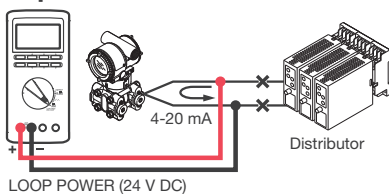

Transmitter simulation function

The CA450 can absorb the current (current SINK) of up to 48 V from an external voltage generating source (e.g. a distributor) and check the loop circuit (using the 20 mA SINK range).

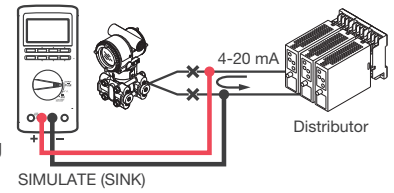

Valve/Positioner application

When checking the open-close position of valve and positioner and adjusting it the CA450 supports your maintenance work efficiently. The step generation function is suitable for performing a step response test. The span check mode function enables switching of 4 mA (0%) and 20 mA (100%) with one key so that it can easily perform zero and span adjustment.

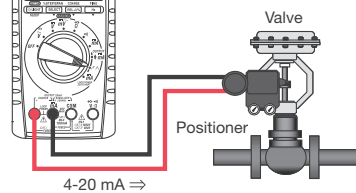

Specifications

	Typical accuracy and range
Measurement unit	
DC voltage	0.09% reading + 1 digit, 600.0 mV to 1000 V
AC voltage (Actual RMS value)	0.5% reading + 5 digit, 600.0 mV to 1000 V (45-500 Hz)
DC current (mA)	0.05% reading + 2 digit/30.000 mA 0.05% reading + 2 digit/100.00 mA
Resistance	0.2% reading + 1 digit, 600.0 Ω to 60.00 MΩ
Frequency	0.005% reading + 1 digit, 199.99 Hz to 19.999 kHz
Diode test	1% reading + 2 digit, 2.000 V
Continuity	Buzzer On when approx. 50±30 Ω or less
Display update (times/second)	2.5 to 5
Data hold	Yes
Peak hold (DC voltage)	Yes
Deviation	Yes
Max./min.	Yes
Source unit	
DC current (mA)	0.05% with respect to the range (20 mA) Range: 0-25 mA 15 V to 48 VDC
Simulate (sink)	0.05% with respect to the range (20 mA) Range: 0-25 mA 28 Vmax
Loop power source function	24 V (ON/OFF function for the resistance of 250 Ω)
Auto step	Yes
Auto sweep	Yes
Step (manual)	Yes
General specs	
Safety standard	EN61010/1000 V CAT. III, 600 V CAT. IV
Communication (option)	IR-USB
Back light	Yes
Operating temperature	-20 to + 55°C
Storage temperature	-40 to + 70°C
Current terminal shutter for preventing incorrect connections	Yes

Conditions Surrounding temperature: 23°C±5°C Relative humidity: 45 to 75% (no condensation)
Measurement accuracy: ±(% of reading + digits)

General specifications

External dimensions	Approx. 90 (W) × 192 (H) × 49 (D) mm
Weight	Approx. 600 g (including batteries)
Power supply	Four alkaline AA batteries (LR6)
Battery life	When alkaline AA batteries are used DC voltage measurement Approx. 140 hours DC current source (SIMULATE) Approx. 140 hours DC current source (SOURCE) 12 mA (load 500 Ω) Approx. 10 hours

Model and Suffix Code

Model	Suffix Code	Description
CA450	-E	CA450 Process Multimeter with English Instruction manual

High-Performance Model Specialized for Loop Inspection



See brochure for details: Bulletin CA300-EN

Features

- Basic accuracy: 0.015% (Source&Meas. accuracy of Voltage mA)
- 20 mA SIMULATE (SINK) function
- Simultaneously supplies 24 V loop power and measure output signal with high accuracy
- HART/BRAIN comm. resistance (250 Ω) embedded
- Sub display displays span% of the source value
- Corresponds to various types of source pattern (Step sweep/Linear sweep/Manual step/Span check)

Applications

Application examples

20 mA SIMULATE (Two-wire Transmitter simulator)

CA310 is capable to execute a loop check by simulating a transmitter, sinking the current signal from the external source (distributor). It achieves the high accuracy 0.015% of setting to source 4-20 mA.

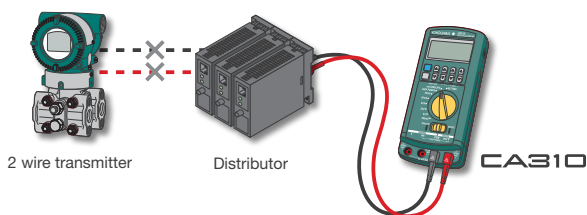

Two-wire Transmitter Loop Check

DC mA signals can be measured by supplying power to the transmitter from a 24 V DC power supply. DC mA measurement and zero-point check can be performed with an accuracy of 0.015% of reading. A 250-ohm resistor for HART and BRAIN communication is included in this calibrator so there is no need to attach an external resistor when connecting to a handy terminal.

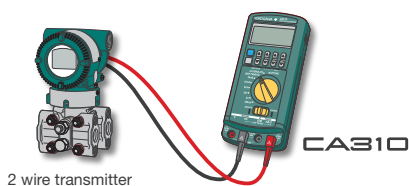

High-Performance Model Specialized for Simulating Thermocouples



See brochure for details: Bulletin CA300-EN

Features

- Basic accuracy: 0.5: (Typical of TC type K) Including accuracy of internal RJC
- Corresponds to 16 types of TC standard (JIS/IEC/DIN/ASTM/GOST R)
- Sub display shows value of voltage source and span (%)
- Corresponds to various types of source pattern (Step sweep/Linear sweep/Manual step/Span check)
- Corresponds to other TC types by mV source function
- Measures TC sensor output as a thermometer

Applications

Application examples

TC SIMULATE

CA320 corresponds to 16 types of TC for sourcing. It achieves the high basic accuracy of 0.5°C (typical of type K), three times better than the previous model which enables it to operate a highly reliable test. Additionally, the difference of temperature between objects can be compensated, by using external RJ sensor or a compensating lead wire.

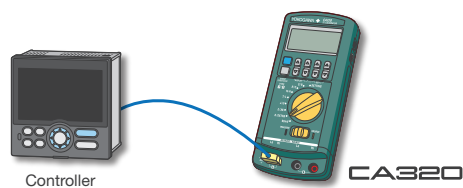

TC MEASURING

CA320 can measure the output of TC like a thermometer. It achieves the basic accuracy of 0.5°C (typical of type K), three times better than the previous model and is for multiple use for process temperature measuring by corresponding to 16 types of TC.

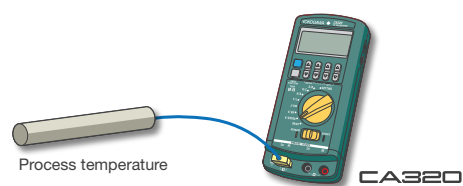

High-Performance Model Specialized for Simulating RTDs



See brochure for details: Bulletin CA300-EN



Features

- Basic accuracy: 0.3°C (Typical of Pt100)
- Corresponds to 14 types of RTD standard (JIS/IEC/GOST R)
- Sub display displays value of resistance source and span (%)
- Corresponds to various types of source pattern (Step sweep/Linear sweep/Manual step/Span check)
- Corresponds to 2, 3, 4 wire. Realizes RTD simulation
- Measures output of RTD sensor as a thermometer

Applications

Application examples

RTD SIMULATE

CA330 corresponds to 14 types of RTD for sourcing. It achieves the high basic accuracy of 0.3°C (typical of type Pt100), twice better than the previous model which enables it to operate a high reliable test.

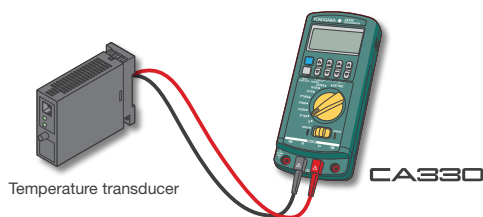

Temperature transducer

RTD MEASURING

CA330 can measure the output of RTD like a thermometer. It achieves the basic accuracy of 0.3°C (typical of type Pt100), twice better than the previous model and is for multiple use of process temperature measuring by corresponding to 14 types of RTD.

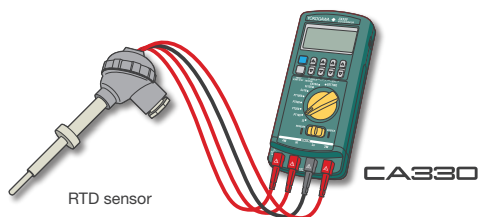

RTD sensor

Functions (Common to CA310/CA320/CA330)

Addition of sub display

The sub display additionally displays span (%), source value of voltage or resistance, while the main displays setting value.



Corresponds to 2 WAY Power supply

Power is supplied by 2 ways: AA Alkaline batteries or AC Adapter



AC Adapter is sold separately

Supports efficient operation with various types of source pattern

Step sweep function

Sources by 25% step automatically from 0% to 100% of span which improves efficiency of operation. It can correspond to various response time of field devices. (15/30/45/60 seconds)

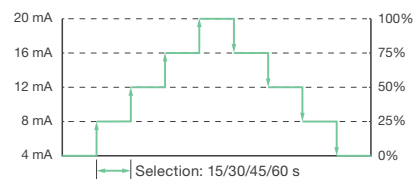

4-20 mA Step sweep source example

Manual step function

Sources by 25% step manually from 0% to 100% of span. Users can do step sourcing at arbitrary timing corresponding to situations.

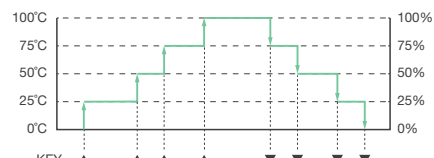

0°C to 100°C Manual step source example

Linear sweep function

Sources continuously from 0% to 100% and is capable to check meter and make linearity tests. Sweep time can be selected by 15/30/45/60 seconds.

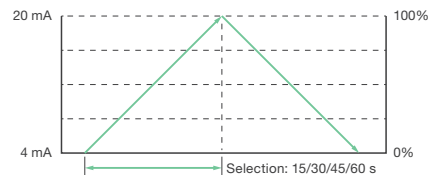

Linear sweep source example

Span check function

Switches sources 0% ⇔ 100% by one touch. With this function, it makes it simple to make adjustment and to inspect the open and close operation of valves.

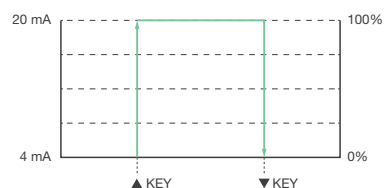

4-20 mA Span check example

Clamp-on Tester Selection Guide

		For AC Current			For AC/DC Current		
		 P. 105	 P. 105	 P. 105	 P. 106	 P. 106	 P. 106
● Available		CL120	CL150	CL155	CL220	CL250	CL255
Diameter of measurable conductor		24 mm diameter	54 mm diameter	54 mm diameter	24 mm diameter	55 mm diameter	55 mm diameter
Method of detection		Mean value	Mean value	True RMS	Mean value	Mean value	True RMS
Frequency characteristics		40 Hz to 1 kHz	40 Hz to 1 kHz	40 Hz to 1 kHz	20 Hz to 1 kHz	40 Hz to 1 kHz	30 Hz to 1 kHz
AC current	Range	20/200 A	400/2000 A	400/2000 A	40/300 A	400/2000 A	400/2000 A
	Resolution	0.01 A	0.1 A	0.1 A	0.01 A	0.1 A	0.1 A
DC current	Range	—	—	—	40/300 A	400/2000 A	400/2000 A
	Resolution	—	—	—	0.01 A	0.1 A	0.1 A
Other measurement functions	AC voltage	—	●	●	—	●	●
	DC voltage	—	●	●	—	●	●
	Continuity check	—	●	●	—	●	●
	Frequency	—	—	—	—	—	●
	Data hold	●	●	●	●	●	●
	Peak hold	—	●	●	—	—	●
	Recorder output	—	●	●	—	●	●
	Waveform monitor output	—	—	—	—	—	—

		For Leakage Current					For DC Current	
		 P. 108	 P. 108	 P. 107	 P. 107	 P. 107	 P. 108	 P. 109
● Available		30031A	30032A	CL320	CL340	CL345	CL360	CL420
Diameter of measurable conductor		40 mm diameter	40 mm diameter	24 mm diameter	40 mm diameter	40 mm diameter	68 mm diameter	6 mm diameter
Method of detection		Mean value	Mean value	Mean value	Mean value	True RMS	Mean value	—
Frequency characteristics		50/60 Hz	50/60 Hz	40 Hz to 400 Hz	20 Hz to 1 kHz	20 Hz to 1 kHz	40 Hz to 1 kHz	—
AC current	Range	3/30 mA, 30/60 A	3/30 mA, 30/60 A	20/200 mA, 200 A	40/400 mA, 400 A	40/400 mA, 400 A	200 mA/2/200/1000 A	—
	Resolution	0.001 mA	0.001 mA	0.01 mA	0.01 mA	0.01 mA	0.1 mA	—
DC current	Range	—	—	—	—	—	—	20/100 mA
	Resolution	—	—	—	—	—	—	0.01 mA
Other measurement functions	AC voltage	—	—	—	—	—	—	—
	DC voltage	—	—	—	—	—	—	—
	Continuity check	—	—	—	—	—	—	—
	Frequency	—	—	—	—	—	—	—
	Data hold	●	●	●	●	●	●	●
	Peak hold	—	—	—	●	●	●	—
	Recorder output	—	—	—	—	—	●	●
	Mean value display	—	●	—	—	—	—	—
	Filter Switch	—	●	●	●	●	●	—
	Waveform monitor output	—	—	—	—	—	●	—

Item		Diameter of measurable conductor	Range	Accuracy ±(reading + digit)	AC current	DC current	Leak current	DC voltage	AC voltage	Resistance	Continuity check	Frequency	True RMS	Output	Data hold	Peak hold	Filter
					●	●	●	●	●	●	●	●	●	●	●	●	●
AC	CL120	24 mm diameter	20 to 200 A	2.0 + 7	●										●		
	CL150	54 mm diameter	400 to 2000 A	1.0 + 3	●			●	●	●	●			●	●	●	
	CL155	54 mm diameter	400 to 2000 A	1.0 + 3	●			●	●	●	●		●	●	●	●	
AC/DC	CL220	24 mm diameter	400 to 300 A	1.0 + 4	●	●		●	●	●	●			●	●	●	
	CL250	55 mm diameter	400 to 2000 A	1.5 + 2	●	●		●	●	●	●			●	●	●	
	CL255	55 mm diameter	400 to 2000 A	1.5 + 2	●	●		●	●	●	●			●	●	●	
ACmA/AC	CL320	24 mm diameter	20 mA to 200 A	2.0 + 4	●		●								●		●
	CL340	40 mm diameter	40 mA to 400 A	1.0 + 5	●		●								●	●	●
	CL345	40 mm diameter	40 mA to 400 A	1.0 + 5	●		●						●		●	●	●
	30031A	40 mm diameter	3 mA to 60 A	1.0 + 5	●		●								●		●
	30032A	40 mm diameter	3 mA to 60 A	1.0 + 5	●		●								●		●
	CL360	68 mm diameter	200 mA to 1000 A	1.0 + 2	●		●								●	●	●
DCmA	CL420	6 mm diameter	DC 20 to 100 mA	0.2 + 3		●								●	●		

● Available

Clamp-on Tester **CL120**



See brochure for details:
Catalog YMI110-EN

Light Weight & Compact Design

Features

- AC current
- 24 mm diameter
- AC: 20 to 200 A

General Specifications

Method of detection	Mean value
Display	LCD (Digital display: 1999 counts)
Response time	Approx. 2 seconds
Range switching	Manual-range
Data hold	On all range
Operating temperature and humidity	0 to 40°C, 85% RH or less (no condensation)
Temperature coefficient	—
Effect of external magnetic field	0.8 A or less at 400 A/m
Effect of conductor position	±2% or less
Safety standard	Conforms EN 61010-1, EN61010-2-032
Circuit voltage	300 Vrms or less
Withstanding voltage	4240 V AC for 5 s
Power supply	LR-44 x 2 (3 V) or SR-44 x 2
Battery life	Approx. 100 hours (continuous)
Consumed current	Approx. 1 mA
Auto power-off	Approx. 10 minutes
Diameter of measurable conductor	24 mm diameter max.
Dimensions	Approx. 59 (W) x 148 (H) x 26 (D) mm
Weight	Approx. 100 g
Accessories	User's manual, batteries, carrying case (93033)

Specifications

Accuracy: (23°C ±5°C, Less than 75% RH), ±(% reading + digit)

Item	Range	Accuracy
AC current	20 A	2.0 + 7 (50 to 1 kHz)
	200 A	2.0 + 5 (50/60 Hz) 3.0 + 10 (40 to 1 kHz)

Model and Suffix Code

Model	Description
CL120	Clamp-on Tester

Clamp-on Tester **CL150/CL155**



See brochure for details:
Catalog YMI110-EN

Wide Range of Current Measurement

Features

- AC current
- 54 mm diameter
- AC: 400 to 2000 A
- AC/DC voltage, Ω
- DC output
- RMS for CL155

General Specifications

	CL150	CL155
Method of detection	Mean value	True RMS
Display	LCD (Digital display: 4000 counts)	
Response time	Approx. 2 seconds	
Range switching	Manual-range (on AC current range)/ Auto-range (on AC voltage range, resistance range)	
Data hold	On all range	
Peak hold	On AC current range	
Operating temperature and humidity	0 to 40°C, 85% RH or less (no condensation)	
Temperature coefficient	—	
Effect of external magnetic field	1 A or less at 400 A/m	
Effect of conductor position	±(2.0% reading + 3 digit) or less	
Safety standard	Conforms EN61010-1, EN61010-2-031, EN61010-2-032	
Circuit voltage	1000 Vrms or less	
Withstanding voltage	6300 V AC for 5 s	
Power supply	R6P (SUM-3) x 2 or LR6 x 2	
Battery life	Approx. 150 hours (continuous)	Approx. 80 hours (continuous)
Consumed current	Approx. 5 mA	Approx. 7 mA
Sleep function	Automatically powered down in about 10 minutes after the last switch operation	
Diameter of measurable conductor	54.5 mm at maximum	54 mm at maximum
Dimensions	Approx. 105 (W) x 247 (H) x 49 (D) mm	
Weight	Approx. 470 g	
Accessories	User's manual, batteries, carrying case (93034), Output plug (98012), Test Lead (98072)	

Specifications

Accuracy: (23°C ±5°C, Less than 75% RH), ±(% reading + digit)

Item	Range	Accuracy
AC current	400 A	1.0 + 3 (50/60 Hz) 2.0 + 3 (40 to 1 kHz)
	2000 A (0 to 1500 A)	1.0 + 3 (50/60 Hz) 3.0 + 3 (40 to 1 kHz)
	2000 A (1500 to 2000 A)	3.0 (50/60 Hz)
AC voltage	40/400/750 V	1.0 + 2 (50/60 Hz) 1.5 + 3 (40 to 1 kHz)
DC voltage	40/400/1000 V	1.0 + 2
Resistance	400/4 k/40 k/400 kΩ	1.5 + 2, Beep sound at less than 50±35 Ω

Model and Suffix Code

Model	Description
CL150	Clamp-on Tester
CL155	Clamp-on Tester

Clamp-on Tester **CL220**



AC/DC Current Measurement

Features

- AC/DC current
- 24 mm diameter
- AC: 40 to 300 A, DC: 40 to 300 A

General Specifications

Method of detection	Mean value
Display	LCD (Digital display: 4000 counts)
Response time	Approx. 2 seconds
Range switching	Auto-range
Data hold	On all range
Operating temperature and humidity	0 to 40°C, 85% RH or less (no condensation)
Temperature coefficient	—
Effect of external magnetic field	1 A or less at 400 A/m
Effect of conductor position	±(2.0% reading + 5 digit) or less
Safety standard	Conforms EN61010-1, EN61010-2-032
Circuit voltage	300 Vrms or less
Withstanding voltage	4240 V AC for 5 s
Power supply	LR-44 × 2 (3 V) or SR-44 × 2
Battery life	Approx. 11 hours (continuous)
Consumed current	Approx. 9 mA
Sleep function	Automatically powered down in about 5 minutes after the last switch operation
Diameter of measurable conductor	24 mm at maximum
Dimensions	Approx. 59 (W) × 147 (H) × 25 (D) mm
Weight	Approx. 100 g
Accessories	User's manual, batteries, carrying case (93033)

Specifications

Accuracy: (23°C ±5°C, Less than 85% RH), ±(% reading + digit)

Item	Range	Accuracy
AC current	40 A	1.0 + 4
	300 A (20 to 200 A)	1.5 + 4
	300 A (200 to 300 A)	3.0
DC current	40 A	1.0 + 4 (50/60 Hz) 2.5 + 4 (20 to 1 kHz)
	300 A (20 to 200 A)	1.5 + 4 (50/60 Hz) 2.5 + 4 (20 to 1 kHz)
	300 A (200 to 300 A)	3.5 (50/60 Hz) 4.0 (20 to 1 kHz)

Model and Suffix Code

Model	Description
CL220	Clamp-on Tester

Portable and Handheld Instruments

Clamp-on Tester **CL250/CL255**



Wide Range of AC/DC Current Measurement

Features

- AC/DC current
- 55 mm diameter
- AC: 400 to 2000 A, DC: 400 to 2000 A
- AC/DC voltage, Ω
- DC output
- Hz, RMS for CL255

General Specifications

	CL250	CL255
Method of detection	Mean value	True RMS
Display	LCD (Digital display: 3999 counts)	
Response time	Approx. 2 seconds	Approx. 1 second (on DC current/voltage range), Approx. 2 seconds (AC current/voltage range, resistance range)
Range switching	Manual-range (on current, voltage range) /Auto-range (on resistance range)	Auto-range
Data hold	On all range	On all range (without peak hold)
Peak hold	On current/voltage range	—
Average Measurement	—	On current/voltage range
Operating temperature and humidity	0 to 40°C, 85% RH or less (no condensation)	
Temperature coefficient	—	
Effect of external magnetic field	4 A or less at 400 A/m	
Effect of conductor position	±(1.5% reading + 3 digit) or less	
Safety standard	Conforms EN61010-1, EN61010-2-031, EN61010-2-032	
Circuit voltage	1000 Vrms or less	
Withstanding voltage	8200 V AC for 5 s	6300 V AC for 5 s
Power supply	R6P (SUM-3) × 2 or LR6 × 2	6F22 (006P) 9 V × 1 or 6LR61 × 1
Battery life	Approx. 100 hours (continuous)	Approx. 15 hours (continuous)
Consumed current	Approx. 9 mA	Approx. 15 mA
Sleep function	Automatically powered down in about 10 minutes after the last switch operation	
Diameter of measurable conductor	55 mm at maximum	
Dimensions	Approx. 105 (W) × 250 (H) × 49 (D) mm	
Weight	Approx. 530 g	Approx. 540 g
Accessories	User's manual, Test Lead (98072), Output plug (98012), batteries, carrying case (93034)	

Specifications

Accuracy: (23°C ±5°C, Less than 75% RH), ±(% reading + digit)

Item	Range	Accuracy	
		CL250	CL255
DC current	400/2000 A	1.5 + 2	1.5 + 2
AC current	400 A/2000 A	0 to 1000 A	1.5 + 2 (50/60 Hz) 3.0 + 4 (40 to 500 Hz) 5.0 + 4 (500 to 1 kHz)
		150 to 1700 A	—
	2000 A	1001 to 2000 A	3.0 + 2 (50/60 Hz)
		1701 to 2000 A	—
			3.5 + 3 (50/60 Hz)
Frequency	10 to 3999 Hz	—	1.5 ± 5

Model and Suffix Code

Model	Description
CL250	Clamp-on Tester
CL255	Clamp-on Tester



See brochure for details:
Catalog YMI110-EN

Compact Design of Leakage Current Measurement

Features

- AC current
- 24 mm diameter
- AC: 20 mA to 200 A

General Specifications

Method of detection	Mean value
Display	LCD (Digital display:1999 counts)
Response time	Approx. 2 seconds
Range switching	Manual-range
Data hold	On all range
Operating temperature and humidity	0 to 40°C, 85% RH or less (no condensation)
Temperature coefficient	—
Effect of external magnetic field	10 mA or less in proximity to a 14.4 mm-diameter conductor carrying 100 A
Effect of conductor position	Within 5 digit for 0 to 50 A, or 2% for 50 to 200 A (10 mm-diameter conductor at inside the jaw)
Effect of residual current	10 mA or less in proximity to a 10 mm-diameter conductor carrying 50 A
Safety standard	Conforms EN61010-1, EN61010-2-032
Circuit voltage	300 Vrms or less
Withstanding voltage	4240 V AC for 5 s
Power supply	LR-44 × 2 (3 V) or SR-44 × 2
Battery life	Approx. 15 hours (continuous)
Consumed current	Approx. 5 mA
Auto power-off	Approx. 10 minutes
Diameter of measurable conductor	24 mm at maximum
Dimensions	Approx. 60 (W) × 149 (H) × 26 (D) mm
Weight	Approx. 120 g
Accessories	User's manual, batteries, carrying case (93033)

Specifications

Accuracy: (23°C ±5°C, Less than 85% RH), ±(% reading + digit)

Item	Range	Accuracy	
		WIDE (40 to 400 Hz)	50/60 Hz
AC current	20 mA/200 mA	2.0 + 4 (50/60 Hz)	3.0 + 5 (50/60 Hz)
	200 A (0 to 100 A)	5.0 + 6 (40 to 400 Hz)	
	200 A (100.1 to 200 A)	5.0 + 4 (50/60 Hz)	5.0 + 5 (50/60 Hz)

Model and Suffix Code

Model	Description
CL320	Leakage Clamp-on Tester



See brochure for details:
Catalog YMI110-EN

Leakage Currents Measurement

Features

- AC current
- 40 mm diameter
- AC: 40 mA to 400 A
- RMS for CL345

General Specifications

	CL340	CL345
Method of detection	Mean value	True RMS
Display	LCD (Digital display: 3999 counts)*	LCD (Digital display: 4200 counts)*
Response time	Approx. 2 seconds	
Range switching	Manual-range	
Data hold	On all range	
Peak hold	On all range	
Operating temperature and humidity	0 to 40°C, 85% RH or less (no condensation)	
Temperature coefficient	—	
Effect of external magnetic field	10 mA or less in proximity to a 15 mm-diameter conductor carrying 100 A	
Effect of conductor position	40/400 mA range: Within 5 digit at every part inside the jaw 400 A range, 0 to 250 A: Within ±0.5% reading ±5 digit at every part inside the jaw section	
Effect of residual current	12 mA or less in proximity to a 10 mm-diameter conductor carrying 100 A	
Safety standard	Conforms EN61010-1, EN61010-2-032	
Circuit voltage	300 Vrms or less	
Withstanding voltage	4240 V AC for 5 s	
Power supply	R0-3 (UM-4) × 2 or LR03 × 2	
Battery life	Approx. 40 hours (continuous)	Approx. 24 hours (continuous)
Consumed current	Approx. 13 mA	Approx. 21 mA
Auto power-off	Approx. 10 minutes	
Diameter of measurable conductor	40 mm at maximum	
Dimensions	Approx. 81 (W) × 185 (H) × 40 (D) mm	
Weight	Approx. 270 g	
Accessories	User's manual, batteries, carrying case (93030)	

*6000 counts (40/400 mA range)

Specifications

CL340 Specifications

Accuracy: (23°C ±5°C, Less than 85% RH), ±(% reading + digit)

Item	Range	Accuracy	
		WIDE (20 Hz)	50/60 Hz
AC current	40 mA/400 mA	2.5 + 10 (20 to 1 kHz)	1.0 + 5 (50/60 Hz)
	400 A (0 to 350 A)	2.5 + 10 (40 to 1 kHz)	1.0 + 5 (50/60 Hz)
	400 A (350 to 400 A)	5.0 (40 to 1 kHz)	2.0 (50/60 Hz)

CL345 Specifications

Accuracy: (23°C ±5°C, Less than 85% RH), ±(% reading + digit)

Item	Range	Accuracy	
		WIDE (20 Hz)	50/60 Hz
AC current	40 mA/400 mA	2.5 + 10 (20 to 1 kHz)	1.0 + 5 (50/60 Hz)
	400 A (0 to 300 A)	2.5 + 10 (40 to 1 kHz)	1.0 + 5 (50/60 Hz)
	400 A (300 to 400 A)	5.0 (40 to 1 kHz)	2.0 (50/60 Hz)

Model and Suffix Code

Model	Description
CL340	Leakage Clamp-on Tester
CL345	Leakage Clamp-on Tester



See brochure for details:
Catalog YMI110-EN

Leakage Currents of 1 mA Measurement

Features

- AC current
- 40 mm diameter
- AC: 3 mA to 60 A

General Specifications

Method	Mean-value detection and rms-value calibration
Display	LCD (Digital reading 3200 counts), Bar graph (32 segments)
Range switching	Range selection Auto or Manual
Data Hold	On all Range
Operating temperature and humidity	0 to 50°C, 80% RH or less (no condensation)
Temperature coefficient	Following values must be added in the temperature range of either 0 to 18°C or 28 to 50°C 0 ≤ I ≤ 50.0 A: ±(0.08% of reading/°C + 0.5 digits/°C) 50.0 < I ≤ 60.6 A: ±(0.3% of reading/°C + 0.5 digits/°C)
Effect of external magnetic fields	0.0005% typical value (in terms of the magnitude of current in adjacent wires)
Safety standard	Conforms EN 61010-1, EN 61010-2-032 CAT. III 300 V
Circuit voltage	300 Vrms or less
Withstanding voltage	3.7 kV AC for one minute
Power supply	CR2032 lithium battery × 1
Power consumption	6 mW maximum
Battery life	Approx. 90 hours
Automatic power-off	Power approx. 10 minutes after the last switch operation.
Dimensions	Approx. 70 (W) × 178 (H) × 25 (D) mm
Weight	Approx. 200 g (including the battery)
Accessories	User's manual, Battery, Soft carrying case (RB057)

Specifications

Accuracy: (23°C ±5°C, Less than 80% RH), ±(% reading + digit)

Item	Range	Accuracy	
		30031A, 30032A Filter OFF	30032A Filter ON
AC current	0 to 30 mA	1.0 + 5 (50±1.0 Hz/60±1.0 Hz)	1.5 + 5 (50±1.0 Hz/60±1.0 Hz)
	0 to 50 A		
	50 to 60 A	5.0 + 5 (50±1.0 Hz/60±1.0 Hz)	5.5 + 5 (50±1.0 Hz/60±1.0 Hz)

Model and Suffix Code

Model	Description
30031A	Leakage Clamp-on Tester
30032A	Leakage Clamp-on Tester



See brochure for details:
Catalog YMI110-EN

Wide Range of Leakage Current Measurement

Features

- AC current
- 68 mm diameter
- AC: 200 mA to 1000 A
- DC/AC output

General Specifications

Method of detection	Mean value
Display	LCD (Digital display: 1999 counts)
Response time	Approx. 1 second
Range switching	Manual-range
Data hold	On all range
Peak hold	On all range
Operating temperature and humidity	-10 to 50°C, 80% RH or less (no condensation)
Temperature coefficient	—
Effect of external magnetic field	15 mA or less in proximity to a 10 mm-diameter conductor carrying 100 A
Effect of conductor position	2% or less
Effect of residual current	10 mA or less in proximity to a 10 mm-diameter conductor carrying 100 A
Safety standard	Conforms EN61010-1, EN61010-2-032
Circuit voltage	600 Vrms or less
Withstanding voltage	4240 V AC for 5 s
Power supply	6F22 (006P) 9 V × 1 or 6LR61 × 1
Battery life	Approx. 60 hours (continuous)
Consumed current	Approx. 5 mA
Diameter of measurable conductor	68 mm at maximum
Dimensions	Approx. 129 (W) × 248 (H) × 55 (D) mm
Weight	Approx. 570 g
Accessories	User's manual, batteries, carrying case (93031)

Specifications

Accuracy: (23°C ±5°C, Less than 85% RH), ±(% reading + digit)

Item	Range	Accuracy	
		WIDE (40 to 1 kHz)	50/60 Hz
AC current	20 mA/2 A/20 A	1.0 + 2 (50/60 Hz)	1.5 + 2
		3.0 + 2 (40 to 1 kHz)	
	200 A	1.5 + 2 (50/60 Hz)	2.0 + 2
		3.5 + 2 (40 to 1 kHz)	
1000 A (0 to 500 A)	1.5 + 2 (50/60 Hz)	2.0 + 2	
	3.5 + 2 (40 to 1 kHz)		
1000 A (501 to 1000 A)	5.0 (50/60 Hz)	5.5	
		10.0 (40 to 1 kHz)	

Model and Suffix Code

Model	Description
CL360	Leakage Clamp-on Tester



See brochure for details:
Bulletin CL420-EN

DC Signals of 4 to 20 mA Measurement

Features

- 0.2% accuracy, 0.01 mA resolution
- Dual display
- LED torch light, Backlight display
- Analog output available

General Specifications

Diameter of measurable conductor	6 mm diameter max.
Display	4-digit LCD Numeric display
Response time	Approx. 1.5 seconds (2.5 seconds when across the range)
Range switching	Auto range
Operating temperature and humidity	-10°C to +50°C 80% RH or less (no condensation)
Safety Standards	EN61010-1, EN61010-2-030, EN61010-2-032
Withstanding voltage	2.21 kV AC for 5 seconds (between the core and the case)
Power supply	Four AA-size alkaline batteries (1.5 V LR6)
Battery life	Approx. 60 hours (continuous) backlight off and LED light off
Other functions	Data hold, Zero adjust function, Auto power off, LED Torch light, Back light display, Illuminant panel
External dimensions and weight	61 (W) × 111 (H) × 40 (D) mm Approx. 290 g (including batteries)
Standard accessories	User's Manual, Batteries, Soft case (93045)

Applications

Examples of analog output application



Example of 98076
output cable
connecting to TY530

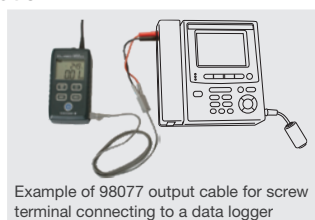

Example of 98077 output cable for screw
terminal connecting to a data logger

Specifications

Item	Range and resolution [Range]	Accuracy ¹
DC current	20 mA: 0.00 to ±21.49 mA	±(0.2% reading + 5 digit) ²
	100 mA: ±21.0 to ±126.0 mA	±(1.0% reading + 5 digit)
DC voltage OUTPUT [10 mV/mA]	20 mA: 0.0 to ±214.9 mV	(DC current Accuracy) + (±0.5 mV)
	100 mA: ±210 to ±1260 mV	(DC current Accuracy) + (±3 mV)

¹ At 23°C ±5°C, 45% to 75% RH, Measurement accuracy: ±(% of reading + digits)
Terms of accuracy: Open and close the clamp sensor after power on and perform zero adjustment.
² The 20 mA range accuracy assurance is the average of 5 times measuring.

Model and Suffix Code

Model	Description
CL420	Clamp-on Process Meter

Standard Accessories (supplied)

Model	Description
93045	Soft case

Optional Accessories (sold separately)

Model	Description
98076	Output cable (banana plug)
98077	Output cable (for screw terminal)

Digital Multimeter Selection Guide



●: Available

...P.111

...P.111

...P.112

...P.112

Item		Product Type/ Model	Digital Multimeter TY720	Digital Multimeter TY710	Digital Multimeter TY530	Digital Multimeter TY520
Basic functions	Detection method		RMS/MEAN (switching)	RMS	RMS/MEAN (switching)	RMS
	Basic accuracy (DC voltage)		0.02%		0.09%	
	Frequency bandwidth		100 kHz	20 kHz	1 kHz	
	Count		50000		6000	
	Bar graph display (units: segment)		51		31	
	Back light		White LED		LED	
Measurement	Voltage (AC/DC)		1000 V	1000 V	1000 V	1000 V
	Current (AC/DC)		10 A	10 A	10 A	10 A
	Resistance		50 MΩ	50 MΩ	60 MΩ	60 MΩ
	Frequency		99.99 kHz	99.99 kHz	99.99 kHz	99.99 kHz
	Capacitance		50 mF	50 mF	1000 μF	1000 μF
	Temperature		+1372°C*	+1372°C*	+600°C*	+600°C*
Other measurement	Duty cycle (%)		●	●	—	—
	Low power resistance		●	—	—	—
	AC + DC		●	●	—	—
	Max./min./avg. value		●	●	●	—
	Diode test		●	●	●	●
	Continuity check		●	●	●	●
	Deviation/percentage (%) calculation		●	●	●	●
	Decibel calculation		●	●	—	—
Additional functions	Auto/manual range		●	●	●	●
	Peak hold		●	—	—	—
	PC connection*		●*	●*	●*	—
	Data logging		●*	●*	●*	—
	Measurement value storage		10000	1000	1600	—
	Operating temperature range		-20 to 55°C	-20 to 55°C	-10 to 55°C	-10 to 55°C
Safety standard	CAT IV		600 V	600 V	600 V	600 V
	CAT III		1000 V	1000 V	1000 V	1000 V
	CAT II		—	—	—	—

*The communication package (model: 92015) for DMM is necessary when connection it with PC.

Provides Safety Levels Demanded in Field Work



Features

- 6000 counts
- High accuracy: 0.09% reading (DC voltage range)
- Supports EN61010-1 1000 V CAT III and 600 V CAT IV
- Can measure AC/DC current with the AC/DC clamp-on probe (sold separately) in the sensor mode
- Includes data memory for logging (up to 1600 data) (only TY530)
- Current terminal shutter for preventing incorrect connections
- Various measurement functions
 - Filter on/off function
 - Maximum, minimum and average value display (only TY530)

Direct readout of sensor output signals

The TY500 series can scale sensor output signals (DC/AC mV) arbitrarily and change their units. (The unit have 16 options.) The dual display enables users to view the output signal and scaled value.

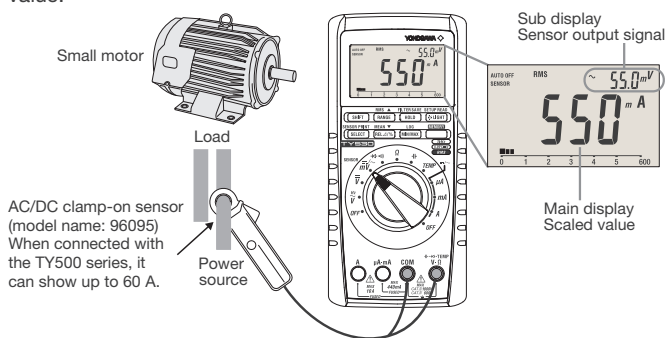

Introduction of our product which can output voltage

Clamp-on probe 960 series^{*1}



^{*1} In addition, the current clamp-on probe 9603X series for the CW series is available. Only the TY520 and TY530 have the scaling function.

Specifications

*Accuracy: ±(% of reading + minimum number of digits)

DC voltage

Range	Accuracy
600 mV/6 V/60 V/600 V	0.09 + 2
1000 V	0.15 + 2

AC voltage

Range	Accuracy		
	500 to 1 kHz	40 to 500 Hz	50/60 Hz
600 mV/6 V/60 V/600 V	1.5 + 5	1 + 5	0.5 + 5
1000 V	—		

DC current

Range	Accuracy
600 μA/6000 μA/60 mA	0.2 + 2
600 mA/6 A/10 A	0.5 + 5

AC current

Range	Accuracy	
	40 to 1 kHz	50/60 Hz
600 μA/6000 μA/60 mA/600 mA/6 A/10 A	1.5 + 5	0.75 + 5

Other

Item	Range	Accuracy
Resistance	600 Ω/6 kΩ/60 kΩ/600 kΩ	0.4 + 1
	6 MΩ	0.5 + 1
	60 MΩ	Less than 0 to 40 MΩ
Frequency	10 to 99.99 kHz	0.02 + 1
Capacitance	1 nF	2 + 10
	100 nF/1 μF/10 μF	2 + 5
	100 μF/1000 μF	3 + 5
Continuity check	600 Ω	Buzzer is turned on when 50±30 Ω or less
Diode test	2 V	1 + 2
Temperature	-50 to 600°C	2 + 2°C

General Specifications

Detection method	TY530: RMS/MEAN (switching), TY520: RMS
Other measurements	On/off switching of low path filter, RMS/MEAN value switching (only TY530)
Additional functions	Data hold/auto hold/range hold/deviation percentage (%) calculation/ auto power off/back light/sensor function (scaling function) Functions included only in TY530: maximum, minimum and average value display, communication function, memory function, logging memory (up to 1600 data)
Applicable standards	Safety standard: EN61010-1, EN61010-031, 1000 V CAT III, 600 V CAT IV pollution level 2 EMC standard: EN61326-1 ClassB, EN55022 ClassB Group 1
Display	3.5-digit LCD (digital display: 6000 counts, dual/bar graph display: 31 segments)
Measurement cycle	5 times/second (digital display), 25 times/second (bar graph display)
Power source and battery life	4 alkaline AA batteries/approx. 300 hours (when direct voltage is measured and alkaline AA batteries are used.)
External dimensions and weight	Approx. 90 (W) × 192 (H) × 49 (D) mm/approx. 570 g (including batteries)
Accessories	Instruction manual/4 alkaline AA batteries/a set of test lead

Model and Suffix Code

Model	Description
TY530	Digital Multimeter
TY520	Digital Multimeter

Supports Measured Data Management Stored in the DMM and Real-Time Communication

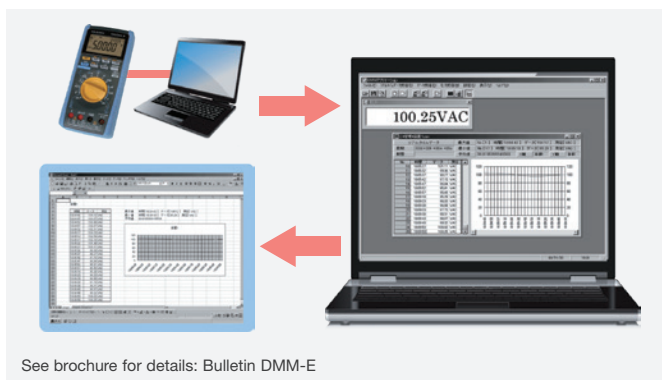

Features

- Saved data can be transmitted from the internal memory to a PC. Data collected in SAVE-memory mode or logging memory mode
- Measurements by the DMM can be monitored on a PC in real time.
- Large amounts of data that cannot be saved in the DMM internal memory can be transmitted to a PC in real time. Data can be written to an Excel* spreadsheet. Maximum number of real-time data transmission: 32767
- Measurement data can be laid out in an Excel spreadsheet.

Specifications

Communication cable

Communication cable	IR communication adapter, USB communication cable: 1
Cable length	2 m
Interface	USB 1.1
Supported models	TY710, TY720, TY530, CA450

Application software

System requirements of PC	
Operating system	Windows 7, 8, 10*
Contents	
CD-ROM software:	1
Communication cable (communication adapter included):	1
User's manual	

*Windows and Excel are registered trademarks of Microsoft Corporation in the United States.

Model and Suffix Code

Model	Description
92015	Communication Package for Digital Multimeters

Digital Multimeters Accessories

Standard Accessories

Product Name/Model/Description		TY720	TY710	TY530	TY520	
Test leads						
98073	1000 V CAT III 600 V CAT IV 1 set each of red and black	●	●	●	●	
Fuse						
99015	440 mA/1000 V (1 pc/1 set)	●	●	●	●	
99016	10 A/1000 V (1 pc/1 set)	●	●	●	●	

●: Compatible

Optional Accessories (Sold Separately)

Product Name/Model/Description		TY720	TY710	TY530	TY520	
DMM communication package						
92015	USB communication adapter + communication cable + application software	●	●	●	●	
Test leads						
99014	1000 V CAT III 600 V CAT IV with alligator clips, 1 set each of red and black	●	●	●	●	
Alligator clips						
B9646HF	Alligator clips, 1 set each of red and black	●	●	●	●	
Carrying case						
93029	Hard case (main unit + test leads + communication cable)	●	●	●	●	
Temperature probe TC (Type-K)						
90050B	Hydraulic: -50 to 600 °C	●	●	●	●	
90051B	Hydraulic: -50 to 600 °C	●	●	●	●	
90055B	Surface: -20 to 250 °C	●	●	●	●	
90056B	Surface: -20 to 500 °C	●	●	●	●	

Product Name/Model/Description		TY720	TY710	TY530	TY520	
Current clamp-on probe						
96010	AC 400 A: output AC 10 mV/A ¹	●	●	●	●	
96030	AC 200 A: output AC 2.5 mV/A ¹	●	●	●	●	
96031	AC 500 A: output AC 1.0 mV/A ¹	●	●	●	●	
96033	AC 50 A: output AC 10 mV/A ¹	●	●	●	●	
96036	AC 2 A: output AC 25 mV/A ¹	●	●	●	●	
96095	AC 130 A/DC 180 A: output AC 10 mV/A, DC 10 mV/A ²	●	●	●	●	

●: Compatible

*1: Please use it with the AC voltage range. It is necessary to read the indicated value in a different way as TY720 and TY710. The example: In AC1V display = 100 A TY520 and TY530, it is possible to scale it. (Even 60 A or less display is possible in case of 96001.)

*2: Please use it with the AC voltage or DC voltage range. It is necessary to read the indicated value in a different way as TY720 and TY710. The example: In AC1V display = 100 A TY520 and TY530, it is possible to scale it. (Even 60 A or less display is possible in case of 96001.)

Improve the Inspection Efficiency with High-Speed Measurement and 6 Range Capability



See brochure for details: Bulletin MY600-01EN



Features

- 6 ranges
- Approximately 0.5 s high-speed measurement*
- Two colors for judging measurement results
- USB communication and memory function
- Line probe with switch is provided as a standard accessory
- Insulation deterioration diagnosis (PI and DAR measurement*)
- Auto LED light

*Under the conditions specified by Yokogawa, it may take time to measure due to the influence of capacitive component of a measuring target.

Specifications

Accuracy (tolerance): Within 1 year of shipment

Rated Measuring Voltage	50 V	100 V*	125 V*	250 V	500 V	1000 V
Maximum Effective Reading	100 MΩ	200 MΩ	250 MΩ	500 MΩ	2000 MΩ	4000 MΩ
First Effective Measurement	0.100 to 10.00 MΩ	0.100 to 20.00 MΩ	0.100 to 25.00 MΩ	0.100 to 50.0 MΩ	0.100 to 500 MΩ	0.100 to 1000 MΩ
Range Accuracy	±2% reading ±2 digit					
Second Effective Measurement	10.01 to 100.0 MΩ	20.01 to 200.0 MΩ	25.01 to 250.0 MΩ	50.1 to 500 MΩ	501 to 2000 MΩ	1001 to 4000 MΩ
Range Accuracy	±5% reading, 0.050 to 0.099 MΩ: ±2% reading ±4 digit					
Other Ranges Accuracy	0.000 to 0.049 MΩ: ±2% reading ±6 digit					

*Switching method

Other Features

Voltage Measurement	AC	2.0 to 600 Vrms (45 to 65 Hz)
	DC	±(2.0 to 600) V
	Accuracy	±1% reading ±4 digit AC/DC auto detection (2 V or more)
Low resistance Measurement	Range	40.00/400.0/4000 Ω (Auto range)
	Accuracy	±2.5% reading ±8 digit (0.20 to 4000 Ω) ±8 digit (0.00 to 0.19 Ω)
Display	Bar graph, 4000 digital count display	
Measurement Categories	CAT III 600 V	
Standard	EN61557-1, 2, 4, 10 EN61326-1 ClassB, EN61326-2-2 EN61010-1, EN61010-031, EN61010-2-30, IEC61010-2-034	

General Specifications

Dimensions	Approx. 156 (W) × 46 (H) × 97 (D) mm
Weight	Approx. 490 g (with battery)
Power source	Four size AA batteries

91030 USB Communication Adaptor Specification

Communication cable	Infrared communication adaptor and Communications cable (USB) 1 set
Cable length	1.9 m
Interface	USB ver. 1.1
Supported model	MY600
Included accessories (attached)	CD Packing contents: Communication driver, User's manual, Install manual

External Dimensions (Spare Probe Tips/Probes)

Unit: mm

[Probes]

98008

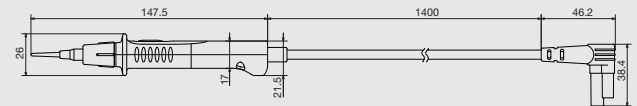

98009

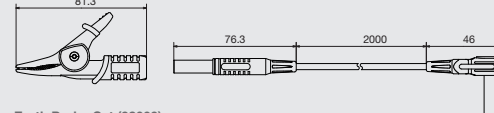

Earth Probe Set (98009)

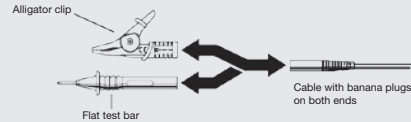

[Spare Probe Tips]

99013

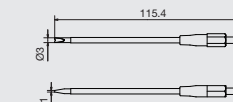

99012

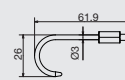

Model and Suffix Code

Model	Description
MY600	Digital Insulation Tester

Accessories

Model	Product Name	Description	Attached
91030	USB communication adaptor	USB communication dedicated cable between PC and the main unit	No
93045	Soft case	Main body and accessory-housing	Yes
98008	Line probe with remote switch	Length: 1.4 m, MY600 only	Yes
98009	Earth probe set	Length: 2.0 m, Earth probe and alligator clip adapters	Yes
99012	Probe tip (hook type)	Size: 61.9 × 26 mm	No
99013	Probe tip (extended type)	Length: 115.4 mm	No
99018	Shoulder strap	For hanging the main body during measurement	Yes

Earth Tester Capable of Measurement with 3-Pole and 2-Pole Procedure



See brochure for details: Catalog YMI110-EN

Features

- Capable to measure by 3-pole or 2-pole measuring
- Easy to measure with one touch button and dedicated test lead
- Small and lightweight
- Dust and drip proof (designed to IEC60529 IP54)

Functions

3-pole earth resistance measurement (precise measurement)

Connect the earth/ground electrode (E) and auxiliary spikes (P, C) to the main body using the accessory test lead. Put apart 5 to 10 m between E and P, and P and C, respectively. E, P, and C should be approximately in a line.

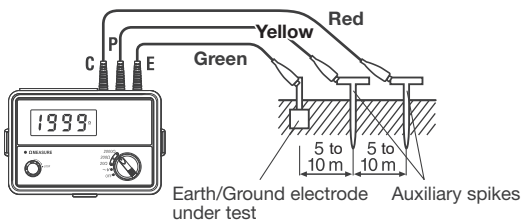

2-pole earth resistance measurement (simplified measurement)

A simplified 2-pole measuring method can be used if there is an almost perfectly earth/ground object such as a lead or iron water-pipe (plastic pipes cannot be used) or if there is an object with a known value of earth resistance, near the measurement site.

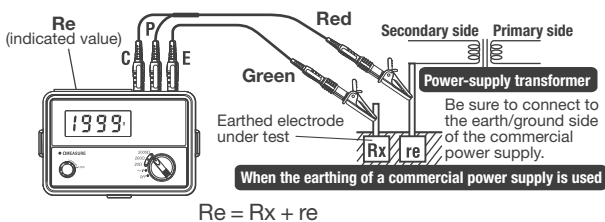

Specifications

Display	LCD Digital Display: 1999-count digital reading	
Measuring Range	Earth Resistance	2000 Ω LSD:0.01 to 1 Ω
	Earth Voltage	200 V
Accuracy	Earth Resistance	20 Ω range: ±2% reading ±0.1 Ω 200 Ω range: ±2% reading ±3 digit 2000 Ω range: ±2% reading ±3 digit
	Earth Voltage	±1% reading ±4 digit
Measuring Frequency	Approx. 820 Hz	
Measuring Current	Approx. 3 mA (at 20 Ω range)	
Battery Life	Approx. 4.5 hours (at 5 second measuring 3300 times)	
Operating Temp. and Humidity	0 to 40°C, 85% Rh or less	
Dimensions	Approx. 102 × 158 × 70 mm	
Weight	Approx. 550 g	
Standard Accessories	3-pole Test Lead (Model 98074), Earth Spikes (for EY200) (Model 98070), 2-pole Test Lead Set (Model 98075), Soft Case (Model 93041), Shoulder Belt (for EY200) (Model 99018), Six AA (R6) dry cells, User's manual	

Model and Suffix Code

Model	Description
EY200	Digital Earth Tester

Simple Thermometer with Easy Operation



See brochure for details: Bulletin TMTX-E

Features

- TX1001: 1-channel Single-function with data hold function
- TX1002: 1-channel Multifunction with data hold, internal memory, user-calibration and relative display function
- TX1003: 2-channel Multifunction with data hold, internal memory, user-calibration and relative display function

Specifications

Thermocouple measurement ranges	Type K: -200 to 1372°C Type J: -200 to 1000°C Type E: -200 to 700°C Type T: -200 to 400°C
Resolution	-200.0 to 199.9°C: 0.1°C, 200°C: 1°C (TX1001) -200.0 to 199.9°C: 0.1°C or 1°C (when resolution is set at 1°C), 200°C: 1°C (TX1002, 03)
Accuracy	-200.0 to -100.1°C: ±(0.1% of reading + 1.0°C); -100.0 to 199.9°C: ±(0.1% of reading + 0.7°C); 200°C and when resolution is set at 1°C: ±(0.2% of reading + 1°C)
General Specifications	External dimensions 56 (W) × 151 (H) × 33 (D) mm Weight Approx. 180 g Power Two AA size (LR6) dry batteries

Accessories

Model	Description (Type)	Measurement Range	Sheath Diameter	Sheath Length	Tolerance
90020B	Rounded end	-50 to 600°C	3.2 mm diameter	200 mm	T < 375°C: ±1.5°C 375°C ≤ T: ±0.004 × T°C
90021B	Rounded end	-50 to 600°C	1.6 mm diameter	150 mm	
90022B	Rounded end	-50 to 600°C	3.2 mm diameter	500 mm	
90023B	Needle	-50 to 500°C	1.6 mm diameter	100 mm	
90024B	Needle	-50 to 500°C	2.1 mm diameter	100 mm	
90030B	Surface straight	-20 to 250°C	Diameter of thermosensitive part 15 mm diameter		(T - Ts) ≤ 100°C: ±2.5°C, 100°C < (T - Ts): -0.03 × T to +2.5°C, T: -20°C to 250°C, Ts: 0°C to 40°C
90031B	Surface angled	-20 to 250°C			
90032B	Surface straight	-20 to 500°C			(T - Ts) < 333°C: +2.5°C, 333°C ≤ (T - Ts): +0.0075 × T°C, (T - Ts) < 167°C: -2.5°C, 167°C ≤ (T - Ts): -0.015 × T°C, T: -20°C to 500°C, Ts: 0°C to 40°C
90033B	Surface angled	-20 to 500°C			

Model	Probe type	Measurement Range	Accuracy	Sensor Diameter/Length (m/m)
90029B	Bead TC	-40 to 260°C	±2.5°C	1200 (included cord)

Thermocouple type: K T: measurement temperature, Ts: ambient temperature

Model and Suffix Code

Model	Description
TX1001	Digital Thermometer
TX1002	Digital Thermometer
TX1003	Digital Thermometer

External Dimensions for 900 series

Unit: mm

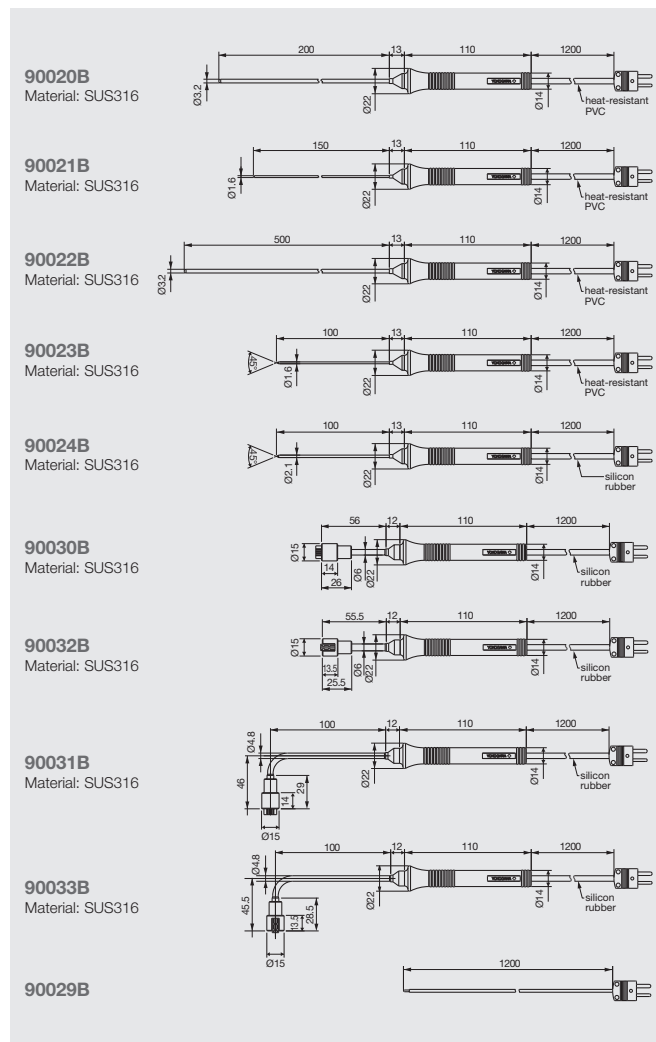

High-End Model for Measuring Power Consumption and Power Quality



See brochure for details: Bulletin CW500-01EN

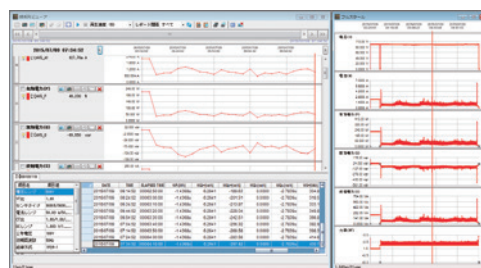

Trend analysis graph

Sample of report

Features

- Achieves various power measurements with simple operations
One press on direct keys switches to any of five measurement displays.
- Identifies power source malfunctions
 - Sampling with a 24- μ s resolution can identify temporary malfunctions.
 - Measures harmonics and flickers
- User support
Easy wiring and setting with the start navigation function and automatic detection of clamp-on probes
- PC software for analysis and setting comes as standard.
Data can be compiled into graphs and reports with one click.

Clamp-on probes for the CW500 power meter

Model	96060 ¹	96061	96062	96063	96064	96065	96066
Clamp-on probe							
Measurable diameter	40 mm diameter	18 mm diameter	24 mm diameter	30 mm diameter	40 mm diameter	110 mm diameter	150 mm diameter
Measuring range	2 A AC	50 A AC	100 A AC	200 A AC	500 A AC	1000 A AC	300 A AC 1000 A AC 3000 A AC
Output voltage	50 mV AC (25 mV/A)	500 mV AC (10 mV/A)	500 mV AC	500 mV AC	500 mV AC	500 mV AC	500 mV AC For each range
Accuracy							
Level							
50 Hz/60 Hz	$\pm 1.0\%$ reading ± 0.05 mV	$\pm 0.5\%$ reading ± 0.1 mV	$\pm 0.5\%$ reading ± 0.1 mV	$\pm 0.5\%$ reading ± 0.1 mV	$\pm 0.5\%$ reading ± 0.1 mV	$\pm 0.8\%$ reading ² ± 0.2 mV	$\pm 1.0\%$ reading ²
40 Hz to 1 kHz	$\pm 2.0\%$ reading ± 0.1 mV	$\pm 0.8\%$ reading ± 0.2 mV	$\pm 1.0\%$ reading ± 0.2 mV	$\pm 0.8\%$ reading ± 0.2 mV	$\pm 1.0\%$ reading ± 0.2 mV	$\pm 1.5\%$ reading ± 0.4 mV	—
1 kHz to 3.5 kHz	$\pm 3.0\%$ reading ± 0.2 mV	$\pm 1.0\%$ reading ± 0.4 mV	—	$\pm 1.0\%$ reading ± 0.4 mV	—	—	—
Accuracy Degree	—	Less than $\pm 2.0^\circ$ (0.5 to 50 A, 40 Hz to 3.5 kHz)	Less than $\pm 2.0^\circ$ (1 to 100 A, 45 Hz to 65 Hz)	Less than $\pm 1.0^\circ$ (2 to 200 A, 40 Hz to 3.5 kHz)	Less than $\pm 1.0^\circ$ (5 to 500 A, 45 Hz to 65 Hz)	Less than $\pm 2.0^\circ$ (45 Hz to 65 Hz) Less than $\pm 3.0^\circ$ (40 Hz to 1 kHz)	Less than $\pm 1.0^\circ$ (for each range/ 45 to 65 Hz)
Max Circuit voltage	AC 300 Vrms	AC 300 Vrms	AC 300 Vrms	AC 600 Vrms	AC 600 Vrms	AC 600 Vrms	AC 600 Vrms
Dimensions	70 x 120 x 25 mm	52 x 106 x 25 mm	60 x 100 x 26 mm	73 x 130 x 30 mm	81 x 128 x 36 mm	73 x 130 x 30 mm	61 x 111 x 43 mm
Weight	Approx. 250 g	Approx. 170 g	Approx. 160 g	Approx. 250 g	Approx. 260 g	Approx. 170 g	Approx. 950 g
Remarks	These probes are dedicated for the CW500 and cannot be used for the CW240/CW120/CW121.						

¹ Clamp-on probe 96060 can not be used for power measurement
² 45 to 65 Hz (measuring at the center of sensor)

Specifications

Wiring connection	1P2W (max. 4 systems ¹), 1P3W (max. 2 systems ¹), 3P3W (max. 2 systems ¹), 3P3W 3 current, 3P4W	
Input	3 channels for voltage, 4 channels for current, 2 channels for DC voltage	
Range	AC voltage	600.0/1000 V
	AC current	2000 mA to 3000 A (depending on a clamp-on probe)
	AC power	3000 W to 3000 kW (depending on a clamp-on probe)
	DC voltage	100.0 mV/1.000 V/10.00 V
Accuracy	Voltage	±0.2% reading ±0.2% range
	Current	±0.2% reading ±0.2% range + accuracy of clamp-on probes
	Power	±0.3% reading ±0.2% range + accuracy of clamp-on probes
	Effect of power factor	±1.0% reading (reading at power factor 0.5 against 1.0)
Measurement items	<ul style="list-style-type: none"> Voltage, current, frequency, power factor, effective/reactive/ apparent power Consumption/generation of effective/apparent power, delay/ progress of reactive power Demand, maximum demand, load factor, estimated demand value Temporary malfunction: voltage swell, voltage dip, voltage interrupt, transient overvoltage, inrush current Continuous malfunction: components of up to the 50th harmonic (RMS, content rate, and phase angle of voltage, current, and power), total harmonic distortion rate, IEC flicker, voltage unbalance rate, current unbalance rate 	
Measurement display	Measurement values, trend graphs for all or each channel from the start of measurement, measured demand values, demand trend over a specific period or a whole period	
Record interval	1/2/5/10/15/20/30 s, 1/2/5/15/20/30 min, 1 h/2 h	
General specification	Dimensions	120 (W) × 175 (H) × 68 (D) mm
	Weight	Approx. 900 g (including batteries)
	Power source	100 to 240 V AC /50 to 60 Hz/Alkaline AA battery × 6/Power supply adaptor (option)
Accessories	Voltage probe, USB cable, Power cord, Carrying bag, SD card, Startup guide, Alkaline AA battery × 6, Input terminal plate × 6, PC software	

¹ Multiple systems can be measured only when they share a common voltage input. Current clamp type and CT ratio are set in common for all systems and cannot be specified individually for each system.

Model and Suffix Code

Model	Suffix Code	Description
CW500		Power Quality Analyzer
	-B0	No Bluetooth Function
	-B1	With Bluetooth Function*
	-D	AC code (UL/CSA)
	-F	AC code (VDE)
	-H	AC code (GB)
	-N	AC code (NBR)
	-P	AC code (KC)
	-R	AC code (SAA)
	-S	AC code (BS)

*Available for USA, Canada and Japan only

Accessories (included with CW500)

Model	Product Name	Description
98078	Voltage Probe	1 set 4 pcs Red Black White Blue 4 mm diameter Approx. 3 m
93046	Carrying Case	CW500 and Clamp-on probe can be contained
97060	SD Memory Card (2 GB)	2 GB SD Memory Card

Accessories sold separately

Model	Product Name	Description
96060	Clamp-on probe	40 mm diameter AC 2 A, Leakage current measurement
96061	Clamp-on probe	18 mm diameter AC 50 A, Load current measurement
96062	Clamp-on probe	24 mm diameter AC 100 A, Load current measurement
96063	Clamp-on probe	30 mm diameter AC 200 A, Load current measurement
96064	Clamp-on probe	40 mm diameter AC 500 A, Load current measurement
96065	Clamp-on probe	Max. approx. 110 mm AC 1000 A flexible type load current measurement
96066	Clamp-on probe	Max. approx. 150 mm AC 3000 A, 3 CH Load current measurement
98082	Extension cable	Extension cable for Clamp-on Probe
98031*	Power supply adapter	Power supply from measure line (100 to 240 V)
93047	Portable case	Case with magnet
99073*	Conversion Cable (Banana-DIN)	For 96030, 96033, 96036

*Non-CE product. Not available for CE marking necessary region.

Highly Accurate DC Variable Resistor with 6 Dials

Features

279301

- High accuracy and stability
- High reproducibility
- 1 mΩ resolution

279303

- Up to 100 MΩ in 100 Ω step
- Low voltage coefficient
- Shock- and vibration-proof construction



See brochure for details:
Bulletin 2700-E

Model and Suffix Code

Model	Description
279301	Decade Resistance Box
279303	Decade Resistance Box

Specifications

	2793031	279303
Resistance Range	0.100 to 1111.210 Ω (Minimum resistance is 0.100 Ω)	0 to 111. 1110 MΩ
Dial Composition	$0.001 \times 10 + 0.01 \Omega \times 10 + 0.1 \Omega \times 11 + 1 \Omega \times 10 + 10 \Omega \times 10 + 100 \Omega \times 10$	$100 \Omega \times 10 + 1 \text{ k}\Omega \times 10 + 10 \text{ k}\Omega \times 10 + 100 \text{ k}\Omega \times 10 + 1 \text{ M}\Omega \times 10 + 10 \text{ M}\Omega \times 10$
Resolution	0.001 Ω	—
Accuracy	$\pm(0.01\% + 2 \text{ m}\Omega)$ at temperature $23 \pm 2^\circ\text{C}$, humidity 45 to 75%, and 0.1 W power application	100 Ω, 1 kΩ, 10 kΩ and 100 kΩ steps ... $\pm(0.05\% + 0.05 \Omega)$ 1 MΩ and 10 MΩ steps ... $\pm 0.2\%$ (At temperature $23 \pm 2^\circ\text{C}$, humidity below 75%, including residual resistance of approx. 0.05 Ω)
Dimensions	Approx. 497 mm × 116 mm × 140 mm (W × H × D)	
Weight	Approx. 4.8 kg	
Accessory	User's Manual 1 copy	

Quick and Easy Setting

Features

Six-dial decade resistance boxes allow quick and easy setting of a wide range of resistance. These resistance boxes are used in combination with voltage or current standards to adjust voltage or current, as dummy load resistances or as an arm of AC bridges.



See brochure for details:
Bulletin 2700-E

Model and Suffix Code

Model	Description
278610	Decade Resistance Box
278620	Decade Resistance Box

Specifications

	278610	278620
Resistance Range	0.1 to 111.111 Ω	1 to 1111.110 Ω
Residual Resistance	Less than 23 mΩ	
Power Rating	0.3 W/step, within 3 W for overall instrument	
Maximum Allowable Input	0.5 W/step, 5 W for overall instrument	
Maximum Circuit Voltage	250 V	
Operating Temperature Range	0 to 40°C	
Storage Temperature Range	-10 to 50°C	
Humidity Range	25 to 85%, relative humidity	
Insulation Resistance	More than 500 MΩ at 500 V DC	
Dielectric Strength	1500 V AC for one minute	
Dimensions	Approx. 497 mm × 116 mm × 140 mm (W × H × D)	
Weight	Approx. 3.5 kg	
Accessory	User's Manual 1 copy	

Metal Foil Resistors

Features

- Traced to the national standard for high accuracy; test (calibrated) accuracy of ± 5 ppm
- Resistance temperature coefficient
- A variety of models
Eight models with nominal resistance values ranging between 0.001 Ω and 10 kΩ
- Precision temperature control equipment, such as an oil bath, not needed for calibration due to marked improvement in resistance temperature coefficient
- Included document: Test certificate



See brochure for details:
Bulletin 2700-E

Model and Suffix Code

Model	Description	Model	Description
2092A01	Standard Resistor	2092A05	Standard Resistor
2092A02	Standard Resistor	2092A06	Standard Resistor
2092A03	Standard Resistor	2092A07	Standard Resistor
2092A04	Standard Resistor	2092A08	Standard Resistor

Specifications

Model	Nominal value	Accuracy $23^\circ\text{C} \pm 2^\circ\text{C}$
2792A01	0.001 Ω	± 100 ppm
2792A02	0.01 Ω	± 75 ppm
2792A03	0.1 Ω	± 50 ppm
2792A04	1 Ω	± 30 ppm
2792A05	10 Ω	
2792A06	100 Ω	
2792A07	1 kΩ	
2792A08	10 kΩ	

Operating temperature and humidity ranges	0 to 50°C/20 to 80% RH
Maximum allowable power	3 W
Test (calibrated) accuracy	± 5 ppm
Power characteristics	± 100 ppm/W
Insulation resistance	More than 1000 MΩ at 500 V DC
Withstand voltage	1.5 kV for one minute between measurement terminal and casing
Terminal construction	4 terminals
External dimensions	Approx 104 mm diameter × 150 mm (current terminal width: approximately 174 mm)
Weight	Approx 1.2 kg
Accessories	User's Manual, One Test Certificate

SMARTDAC+ Paperless Recorder GP Series, Data Acquisition System GM

A Next-generation Data Acquisition and Control System with Excellent Operability and Expandability

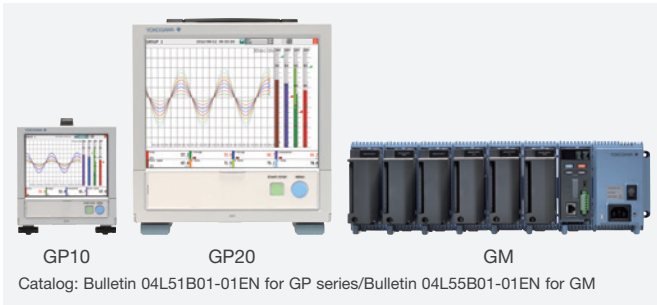

Dual interval measurement with two different scan intervals

Provides for efficient, simultaneous measurement of signals with slow fluctuations such as temperature, and fast-changing signals such as pressure and vibration, with two different scan intervals in a single system.



Multi-unit configuration by connecting expansion units

Supports measurements at up to 450 ch (GP20) and 420 ch (GM10)

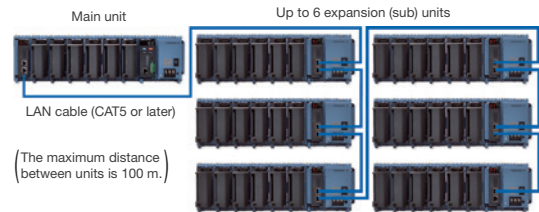

Acquire data from power measuring instruments

The GP recorder and the GM system can acquire data from power measuring instruments (WT series power analyzers) without loss of fidelity and record and display with their own data (option codes /E2 and /MC).

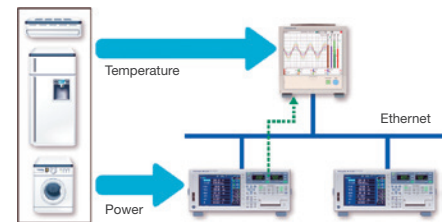

Specifications

Model	GP10	GP20-1	GP20-2	GM10-1	GM10-2
Mounting	Desktop			Desktop, DIN rail, vertical panel mount (screws)	
Display (TFT color LCD)	5.7" (640 × 480 dots)	12.1" (800 × 600 dots)		—	
Touch screen	4-wire resistive touch screen, 2-point touch detection			—	
No. of connectable modules	3	10		10 (Up to 8 when GX90XA-10-T1 or -04-H0 is mounted)	
Max. (with expansion units)	10	10	45	10	42
Max. no. of I/O channels	100	100	500	100	500
No. of connectable WT communication units (/E2*)	8	16	16	16	16
No. of communication channels (/MC*)	50	300	500	300	500
No. of channels allocatable to WT (/E2*)	50	300	300	300	300
No. of mathematical channels (MT*)	50	100	200	100	200
No. of recording channels	500	500	1000	500	1000
Internal memory (flash)	500 MB	500 MB	1.2 GB	500 MB	1.2 GB
Communication interface	Ethernet, RS-232 (/C2*), RS-422/485 (/C3*), USB host (/UH*)			Ethernet, USB, RS-422/485 (/C3*), Bluetooth (/C8*)	
Rated supply voltage	AC model	100 to 240 VAC			100 to 240 VAC
	DC model	12 VDC			12 to 28 VDC
Dimensions (W × H × D) with modules mounted	144 × 168 × 248 (mm)	288 × 318 × 248 (mm)		Max. 638 × 137.7 × 146 (mm)	
Ambient temperature	0 to 50°C			-20 to 60°C (-20 to 50°C for some configurations)	

Measurement interval
 Normal mode: 100/200/500 ms, 1/2/5 s
 High speed or Dual interval mode: 1/2/5/10/20/50/100/200/500 ms, 1/2/5 s (Available intervals depend on system configurations and modules.)

External storage media
 1 to 32 GB SD/SDHC memory card (a 1 GB card is included)
 Format: FAT32 or FAT16

Data format
 Normal mode: Binary or text;
 High speed or Dual interval mode: Binary

Ethernet
 10Base-T/100Base-TX (E-mail, FTP, Web, SNMP, etc.)

WT communication (/E2*)
 Supported models: WT1800, WT500, WT300
 Supported communication: Ethernet
 Communication interval: 500 ms, 1/2/5/10/20/30 s

USB host for GP (/UH*)
 Complies with USB 2.0 (USB memory; keyboard or mouse complying with HID Class Ver. 1.1)

USB communication for GM
 Complies with USB 2.0 (recognized as a serial port by a PC)

Bluetooth for GM (/C8*)
 Bluetooth® Ver 2.1+EDR compliant, SPP (serial port profile), Class 2 (communication range: approx. 10 m depending on the usage environment)

*Option code

Expansion (sub) unit specifications	GX60	GM configuration
Construction	Desktop, vertical panel mount (screws)	Desktop, DIN rail, vertical panel mount (screws)
No. of connectable modules	6	6
Rated supply voltage	AC model	100 to 240 VAC
	DC model	12 to 28 VDC
Dimensions (W × H × D) with modules mounted	412.5 × 164.7 × 147 (mm)	Max. 438 × 137.7 × 146 (mm)
Ambient temperature	0 to 50°C	-20 to 60°C (-20 to 50°C for some configurations)

Smart user interface for intuitive operation (GP series)

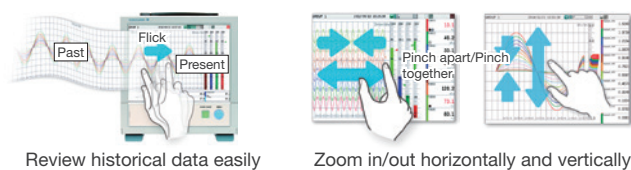

Monitoring and setting on a tablet (GM10)

Supports Bluetooth (option code/C8). There is no need to bring a PC to the site; you can use a tablet for setting and monitoring.



Model and Suffix Code

Please contact us for the prices.

Model	Suffix Code	Description
GP10		Paperless recorder (portable type with a small display)
GP20		Paperless recorder (portable type with a large display)
Type	-1	Standard (max. measurement channels: 100)
	-2	Large memory (max. measurement channels: 500) (GP20 only)
Display Language	E	English, degF, DST (summer/winter time)
Power Supply	1	100 VAC, 240 VAC *Power cord W cannot be specified
	2	12 VDC (GP10 only) *With power cord W only
Power Cord	D	Power cord UL/CSA standard
	F	Power cord VDE standard
	R	Power cord AS standard
	Q	Power cord BS standard
	H	Power cord GB standard
	N	Power cord NBR standard
	W	Screw terminal, power cord not included
Optional Features	/AH	Aerospace heat treatment
	/AS	Advanced security function (Part 11)
	/BT	Multi-batch function
	/C2	RS-232
	/C3	RS-422/485 *Cannot be specified together.
	/CG	Custom display
	/D5	VGA output (only for GP20)
	/E1	EtherNet/IP communication (PLC communication protocol)
	/E2	WT communication */MC option must be specified.
	/E3	OPC-UA server
	/E4	SLMP communication (Mitsubishi PLC)
	/FL	Fail output (1 point)
	/LG	Log scale
/MC	Communication channel function	
/MT	Mathematical function (with report function)	
/PG	Program control function *PID control module is required.	
/UH	USB interface (2 host ports)	

Recorders can be shipped with specified I/O modules mounted (optional).

Model	Suffix Code	Description
GM10		Data Acquisition Module for SMARTDAC+ GM
Type	-1	Standard (Max. measurement channels: 100)
	-2	Large memory (Max. measurement channels: 500)
Area	E	General (temp. unit: Cel, degF)
	0	Always 0
Optional Features	/AH	Aerospace heat treatment
	/AS	Advanced security function (Part 11)
	/BT	Multi-batch function
	/C3	RS-422/485
	/C8	Bluetooth
	/E1	EtherNet/IP communication (PLC communication protocol)
	/E2	WT communication *MC option must be specified.
	/E3	OPC-UA server
	/E4	SLMP communication (Mitsubishi PLC)
	/LG	Log scale
	/MC	Communication channel function
	/MT	Mathematical function (with report function)
	/PG	Program control function *PID control module is required.

Model	Suffix Code	Description
GM90PS		Power Supply Module for SMARTDAC+ GM
Type	-1	Always -1
Region	N	General
Supply Voltage	1	100 to 240 VAC
	2	12 to 28 VDC *Power Supply Connection: W only
Power Supply Connection	D	Power inlet with UL/CSA cable
	F	Power inlet with VDE cable
	H	Power inlet with GB cable
	N	Power inlet with NBR cable
	Q	Power inlet with BS cable
	R	Power inlet with AS cable
	W	Screw terminal (without power cable)
	0	Always 0

I/O Modules and GX90EX (I/O expansion module)

Model	Suffix Code	Name	Specification/Application	Shortest cycle	
GX90XA	-10-U2N-□□	Analog input module	10 ch, DCV/TC/RTD/DI, SSR scanner type (RTD b-terminal common)	DCV: ±20/60/200 mV, 1/2/6/20/50 V, etc.	100 ms
	-10-V1N-□□		10 ch, high withstand voltage, DCV/TC/DI, SSR scanner type (isolated between channels)	TC: R/S/B/K/E/J/T/N, etc.	100 ms
	-10-L1N-□□		10 ch, low withstand voltage, DCV/TC/DI, SSR scanner type (isolated between channels)	RTD: Pt100/JPt100, etc.	500 ms
	-10-T1N-□□		10 ch, DCV/TC/DI, electromagnetic relay scanner type (isolated between channels)	DI: Voltage/contact	1 s
	-10-C1N-□□		10 ch, current (mA), SSR scanner type (isolated between channels)	Current (mA): 0 to 20/4 to 20 mA	100 ms
	-04-H0N-□□		4 ch, DCV/TC/RTD/DI, individual A/D type (isolated between channels)		1 ms
GX90YA	-04-C1N-□□	Analog output module	4 ch, current (mA), (isolated between channels)	Current (mA): 0 to 20/4 to 20 mA	100 ms
	-16-11N-□□	Digital input module	16 ch (shared common)	[Input] Open collector or non-voltage contact, Application: Remote control or operation recording/pulse (125 Hz when filter is ON)	100 ms
GX90YD	-06-11N-3N	Digital output module	6 ch	[Output] Form C relay (SPDT), Application: Alarm output	100 ms
GX90WD	-0806-01N-3N	Digital I/O module	Input 8 ch (shared common), output 6 ch		100 ms
GX90XP	-10-11N-□□	Pulse input module	10 ch (shared common)	DC Voltage, Open collector or non-voltage contact, Application: Pulse (up to 20 kHz)	100 ms
GX90UT	-02-11N-3N	PID control module	PID control (2 loops)		100 ms
GX90EX	-02-TP1N-N	I/O expansion module	Each of GP main body, GM main unit, and expansion (sub) unit can mount one GX90EX. (One GX90EX is provided with a GX60.)		—

The "□" in the suffix code represents the terminal form (-3: M3 screw terminal, -C: Clamp terminal) Up to 10 modules consisting of GX90YD, GX90WD, and GX90UT can be mounted in a system. Each of the GP main body, GM main unit, and expansion (sub) unit can mount one GX90WD. The /MT option (MATH) is required for GX/GP/GM main unit to perform pulse measurement/integration on GX90XD/GX90WD, or pulse integration on GX90XP. For other limitations, please refer to product brochure or general specifications.

Model	Suffix Code	Description
GM90MB	-01N0	Module Base for SMARTDAC+ GM

Model	Suffix Code	Description
GX60		I/O base unit
Type	-EX	I/O expansion
Area	N	General
Power Supply	1	100 VAC, 240 VAC
Power Cord	D	Power cord UL/CSA standard
	F	Power cord VDE standard
	R	Power cord AS standard
	Q	Power cord BS standard
	H	Power cord GB standard
	N	Power cord NBR standard
	W	Screw terminal (power cord not included)

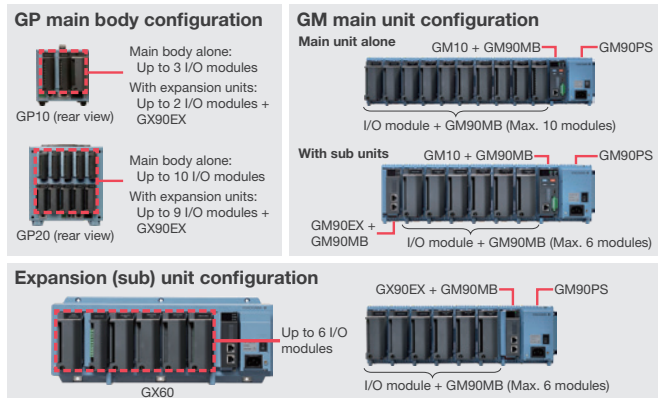

SMARTDAC+ Data Logging Software GA10

Monitor and record data from Power Meters, Recorders, and Data Loggers

Catalog: Bulletin 04L65B01-01EN <http://www.smartdacplus.com/>

GA10 is a PC based software package that acquires data from multiple devices – such as power meters (WT series), recorders, and data loggers. Connected PCs can monitor real time and historical data, which can be stored on a PC hard drive.

Specifications

Max. connectable devices	100
Max. connectable clients	Unlimited (Connection with up to 32 units has been verified.)
Max. recording tags (channels)	Tags: 10000 ch, Mathematical tags (option code/MT): 2000 ch
Scan interval	100 ms at shortest (depending on the scan interval of each instrument when using instrument time)
Supported WT model	WT300*, WT500*, WT1600*, WT1800*, WT3000, WT3000E *Free connection software GateWT for GA10 available

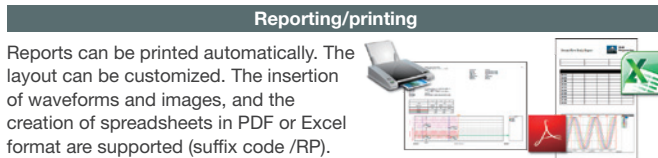
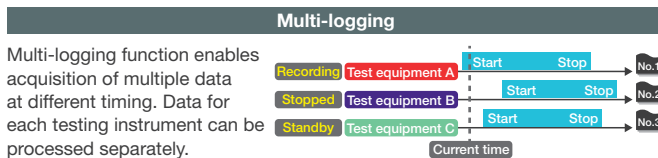

Yokogawa Test & Measurement Global Network

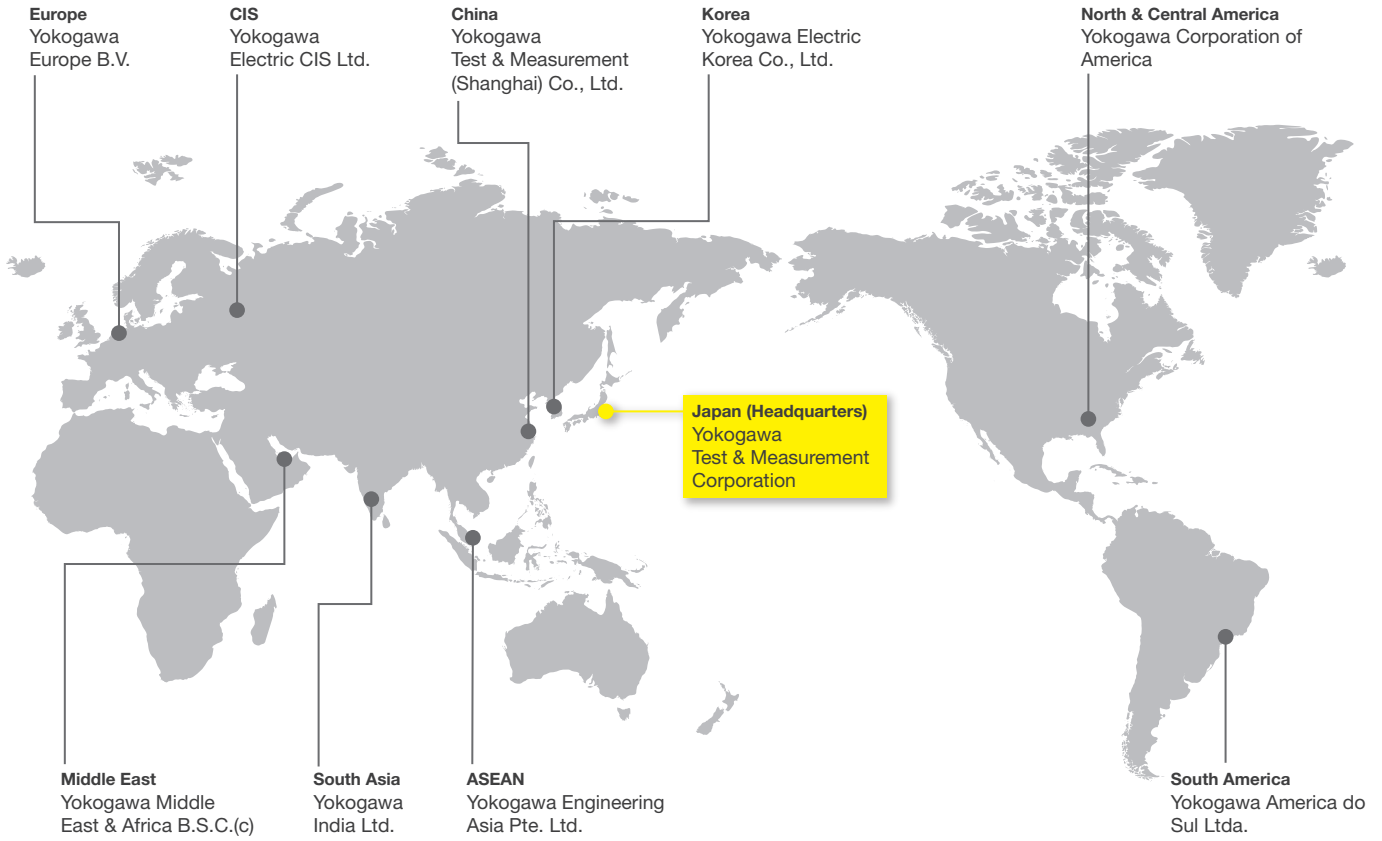

The following Web site offers a variety of information and services, such as document download, software download, user registration, e-mail news subscription and other.

Our Web site will help you find what you look for.

The screenshot shows the Yokogawa Test & Measurement website homepage. At the top, there is a navigation bar with the Yokogawa logo, a 'Global' dropdown menu, and links for 'News & Events', 'About Us', 'Sign In', and 'Search'. Below the navigation bar, there are tabs for 'Industries', 'Products', 'Library', 'Support', and 'Contact Us'. The main content area features a large banner with the text 'Meet the Precision Makers' and 'The world's most trusted measurement partner', accompanied by an image of a technician working with a laptop and various test equipment. To the right of the banner is a yellow square and a photograph of a wind turbine. Below the banner is a 'Spotlights' section with two featured products: the AQ6373E and AQ6374E Optical Spectrum Analyzers, and the IS8000 Integrated Software Platform. The 'Product Categories' section follows, displaying a grid of eight product categories with representative images: Oscilloscopes, Power Analyzers, Data Acquisition (DAQ), Optical Test Equipment, Generators, Sources, Portable Ethernet Testers, Portable and Handheld Instruments, and Other Test and Measurement Instruments. At the bottom, there is a horizontal navigation bar with four categories: 'Industries', 'Products', 'Library', and 'Support', each with a corresponding image.

⚠ NOTICE

- Before using the product, read the instruction manual carefully to ensure proper and safe operation.

YOKOGAWA 

<https://tmi.yokogawa.com/>

YMI-N-MI-M-E03

YOKOGAWA TEST & MEASUREMENT CORPORATION

Global Sales Dept. /E-mail: tm@cs.jp.yokogawa.com

The contents are as of January 2024. Subject to change without notice.

Copyright © 2024, Yokogawa Test & Measurement Corporation

[Ed: 01/b] Printed in Japan, 401(KP)

YOKOGAWA CORPORATION OF AMERICA

YOKOGAWA EUROPE B.V.

YOKOGAWA TEST & MEASUREMENT (SHANGHAI) CO., LTD.

YOKOGAWA ELECTRIC KOREA CO., LTD.

YOKOGAWA ENGINEERING ASIA PTE. LTD.

YOKOGAWA INDIA LTD.

YOKOGAWA ELECTRIC CIS LTD.

YOKOGAWA AMERICA DO SUL LTDA.

YOKOGAWA MIDDLE EAST & AFRICA B.S.C(c)

<https://tmi.yokogawa.com/us/>

<https://tmi.yokogawa.com/eu/>

<https://tmi.yokogawa.com/cn/>

<https://tmi.yokogawa.com/kr/>

<https://tmi.yokogawa.com/sg/>

<https://tmi.yokogawa.com/in/>

<https://tmi.yokogawa.com/ru/>

<https://tmi.yokogawa.com/br/>

<https://tmi.yokogawa.com/bh/>